



**AIT 2019**  
*International conference*

IX International conference

**APPLIED INTERNET AND INFORMATION TECHNOLOGIES 2019**

## **CONFERENCE PROCEEDINGS**

October 3-4, 2019  
Zrenjanin, Serbia





**University of Novi Sad  
Technical faculty "Mihajlo Pupin"  
Zrenjanin  
Republic of Serbia**



IX INTERNATIONAL CONFERENCE

**APPLIED INTERNET AND INFORMATION TECHNOLOGIES**

AIIT2019

# PROCEEDINGS



[www.tfzr.uns.ac.rs/aiit](http://www.tfzr.uns.ac.rs/aiit)

October 3-4, 2019  
Zrenjanin, Republic of Serbia

**Publisher and organizer of the conference:**

University of Novi Sad, Technical faculty "Mihajlo Pupin", Zrenjanin, Republic of Serbia

**For publisher:**

Dragica Radosav, PhD, Professor  
Dean of Technical faculty "Mihajlo Pupin", Zrenjanin,  
Republic of Serbia

**Proceedings editors:**

Ljubica Kazi, PhD – main editor  
Evgeny Cherkashin, PhD  
Blagoj Ristevski, PhD

**Conference chairman:**

Ljubica Kazi, PhD, assistant professor

**Cover design:**

Ljubica Kazi, PhD  
Dušanka Milanov, MSc

**Conference co-chairmen:**

Evgeny Cherkashin, PhD  
Blagoj Ristevski, PhD

**Technical preparation of proceedings:**

Ljubica Kazi, PhD  
Zoltan Kazi, PhD  
Siniša Mihajlović, MSc

**e-Proceedings**

ISBN: 978-86-7672-327-0

**Disclaimer:**

All rights reserved. No part of this proceeding may be reproduced in any form without written permission from the publisher. The publisher and editors are not responsible either for the statements made or for the opinion expressed in this publication. The authors solely are responsible for the content of the papers and any copyrights, which are related to the content of the papers.

CIP - Каталогizacija u publikaciji  
Biblioteka Matice srpske, Novi Sad

004(082)

**INTERNATIONAL Conference on Applied Internet and Information Technologies (9 ;  
2019 ; Zrenjanin)**

Proceedings [Elektronski izvor] / IX International Conference on Applied Internet and Information Technologies AIIT 2019, Zrenjanin, October 3-4, 2019 ; [organizatori] Technical Faculty "Mihajlo Pupin", Zrenjanin. - Zrenjanin : Tehnički fakultet "Mihajlo Pupin", 2019. - 1 elektronski optički disk (CD-ROM) : tekst, ilustr. ; 12 cm

Sistemske zahteve: Nisu navedeni. - Nasl. sa naslovnog ekrana. - El. publikacija u formatu pdf opsega 353 str. - Bibliografija uz svaki rad.

ISBN 978-86-7672-327-0

a) Информационе технологије -- Зборници

COBISS.SR-ID 331967751

## MAIN ORGANIZING INSTITUTION

---



University of Novi Sad  
Technical Faculty "Mihajlo Pupin"  
Zrenjanin  
SERBIA  
<http://www.tfzr.uns.ac.rs/>

## ORGANIZING PARTNER INSTITUTIONS



"St. Kliment Ohridski" University  
Faculty of Information and Communication Technologies  
Bitola  
NORTH MACEDONIA  
<http://www.fikt.edu.mk/>



Irkutsk National Research Technical University  
Institute of High Technologies, Irkutsk  
Matrosov Institute for System Dynamics and Control Theory SB RAS  
Irkutsk  
RUSSIA  
<http://www.istu.edu/>



Irkutsk State Transport University  
Irkutsk  
RUSSIA  
[www.irgups.ru/en/about-university](http://www.irgups.ru/en/about-university)



South-west university "Neophyte Rilsky"  
Faculty of Engineering  
Blagoevgrad  
BULGARIA  
<http://www.swu.bg/>

## CONFERENCE CHAIRMAN

---



**Ljubica Kazi, PhD**  
University of Novi Sad  
Technical Faculty "Mihajlo Pupin"  
Zrenjanin  
SERBIA

## CO-CHAIRMEN



**Evgeny Cherkashin, PhD**  
Irkutsk National Research Technical University  
Matrosov Institute for System Dynamics and Control Theory SB RAS  
Institute of High Technologies  
Irkutsk  
RUSSIA



**Blagoj Risteovski, PhD**  
"St. Kliment Ohridski" University  
Faculty of Information and Communication Technologies  
Bitola  
NORTH MACEDONIA

## **INTRODUCTION**

International conference on Applied Internet and Information Technologies (AIIT) is an annual conference that was held since 2012, based on successful results of International conference on Information and Communication Technologies for Small and Medium Enterprises in 2011. This year, AIIT2019 it was held on October 3-4, 2019 in Zrenjanin, Serbia.

The objectives of the International conference on Applied Internet and Information Technologies are aligned with the goal of regional economic development. The conference focus is to facilitate implementation of Internet and Information Technologies in all areas of human activities. The conference provides forum for discussion and exchange of experiences between people from government, state agencies, universities, research institutions and practitioners from industry. Information technologies change during time and this year AIIT conference addressed diversity of ICT application areas and relevant research topics such as:

*Information systems*

*Software engineering and applications*

*Data science and big data technologies*

*Business intelligence*

*IT support to decision-making*

*Communications and computer networks*

*Data and system security*

*Distributed systems*

*Internet of Things*

*Embedded systems*

*Software quality*

*Software maintenance*

*Computer graphics*

*IT management*

*E-commerce*

*E-Government*

*E-Education*

*Internet marketing*

Information technologies enable collaboration across the globe. This year the conference was successfully co-organized by 6 institutions from 4 countries - Serbia, North Macedonia, Russia and Bulgaria. It has been managed in collaboration of 3 co-chairmen from Serbia, North Macedonia and Russia.

The conference included presentation of plenary lectures and regular papers - at main location in Zrenjanin, Serbia and one oral section in Irkutsk, Russia. There were more than 60 papers presented within oral and poster sessions, from 12 countries (Egypt, North Macedonia, Montenegro, Russia, Bosnia and Herzegovina, Bulgaria, Malta, India, UK, USA and Hungary).

Within the main conference event, there were also two presentations of IT companies – “Vega IT sourcing” and “CRATER”. Round table was held with the representatives from universities, Zrenjanin IT cluster and IT companies with the topic „Improving higher education according to the needs of ICT industry and e-Government”, particularly to address issues in forthcoming accreditation.

The AIIT organizing committee would like to thank authors of papers for their contribution. All submitted papers were peer reviewed by the members of AIIT2019 program committee. Each submitted paper was assigned to at least two reviewers from different countries and the paper analysis was conducted as double blind review. Special gratitude is addressed to many reviewers from co-organizing institutions that made great impact on quality of papers. The AIIT organizing committee specially appreciate IT companies’ efforts in supporting the conference by their participation at the round table - with the aim to encourage improving university teaching to be aligned with the IT industry needs.

Information technologies are integrated in every human activity. IT application enhancements are encouraged by university research, business organizations, public institutions and IT industry. The AIIT organizing committee welcomes future presentations of work in this field at next AIIT conference.

Ljubica Kazi, conference chairman

Evgeny Cherkashin, conference co-chairman

Blagoj Ristevski, conference co-chairman

## CONTENTS

### INVITED PAPERS

Abdel - Badeeh M. Salem ARTIFICIAL INTELLIGENCE IN SMART EDUCATION AND LEARNING SYSTEMS: TECHNIQUES, APPLICATIONS AND CHALLENGES	1
Stoyan Cheresharov, Kremena Stefanova, Ivan Jelev, Veselina Naneva A PROTOTYPE OF A SYSTEM FOR E-LEARNING	10
Dušan Gajić, Dinu Dragan BLOCKCHAIN FOR BUSINESS: TECHNOLOGY AND APPLICATIONS	17
Srdan Popov SMART CITY – GIS AND IOT INTEGRATION	24

### REGULAR PAPERS

B. Ristevski USING GRAPH DATABASES FOR QUERYING AND NETWORK ANALYSING	28
B. Ristevski, S. Savoska ANALYSIS AND SIMULATION OF BIOLOGICAL COMPLEX NETWORKS	33
I.S. Hristoski, T.M. Spaseska, D.S. Odžaklieska, T.P. Dimovski ANALYZING CONSUMER SPENDING BEHAVIOR USING GRAPH DATABASES	37
A. Shijakova, Z. Kotevski FAKE NEWS DETECTION IN SOCIAL MEDIA: A SURVEY	45
K. Veljanovska, M. Filiposka NEXT GENERATION NETWORKS (5G TECHNOLOGY) - PERFORMANCE ANALYSIS	49
L. Tanaskoska, A. Stamenkovska, S. Savoska, I. Jolevski, N. Blazheska – Tabakovska and B. Ristevski OPTIMIZING BLUETOOTH COMMUNICATION BETWEEN MEDICAL DEVICES AND ANDROID	53
M. Zlatkovski, B. Ristevski, S. Savoska, N. Blazheska - Tabakovska, A. Bocevska DEVELOPMENT OF AN EDUCATIONAL AUGMENTED REALITY APPLICATION	59
A. Dimitrievski, S. Savoska, I. Chorbev, B. Ristevski, V. Trajkovik DATA PROCESSING WITHIN AMBIENT ASSISTED LIVING SYSTEM	65
N. Blazheska - Tabakovska, S. Savoska, B. Ristevski, I. Jolevski, D.Gruevski WEB CONTENT ACCESSIBILITY FOR PEOPLE WITH COGNITIVE DISABILITIES	70
L. Ivanovska USING COMPUTERS AS A LEARNING TOOL IN ENGLISH LANGUAGE TEACHING	75
A. Bocevska, Z. Kotevski, N. Rendevski, B. Ristevski MARKER BASED MOBILE AUGMENTED REALITY FOR APPLICATION OF VISUALIZATION IN PRODUCT PACKAGING	79
C. Andreeski, M. Blazhekovikj - Toshevski IMPACT OF SUBSIDIES ON TOURISM THROUGH ANALYSIS OF DATA SERIES ON ARRIVED TOURISTS FROM DIFFERENT EMISSION ZONES	83

E. Balci, C. Felix, E. Bertini AUTOMATIC LABELING OF TOPIC MODELS USING DEEP LEARNING	88
S. Nogo, D. Manjak USING ORACLE REST DATA SERVICES FOR GENERATING JSON DOCUMENTS	94
G. Jauševac , Ž. Stojanov, G. Jotanović, V. Brtko A SURVEY OF ICT COMPETENCIES OF GRADUATE STUDENTS AT TRAFFIC ENGINEERING FACULTY IN DOBOJ	100
V. Erceg, Z. Ćirić, T. Zoranović MATURITY IN AGILE SOFTWARE DEVELOPMENT PROCESSES	105
V. Erceg, L. Šereš, T. Zoranović DATA QUALITY ASSESSMENT	112
D. Zlatković, N. Denić, M. Petrović E-LEARNING IN HIGHER EDUCATION – AN OVERVIEW OF STRATEGIC PLANNING	117
N. Ranković, T. Radmanović, D. Ranković, M. Bjelica VISUALIZATION TOOLS FOR LARGE AMOUNT OF DATA	122
V. Kraguljac, D. Milošević, T. Dlabac SECURITY OF THE MOST FREQUENTLY USED WEB CONTENT MANAGEMENT SYSTEMS	128
M. Blagojević, N. Stanković and M. Papić KNOWLEDGE AND IMPORTANCE OF DIFFERENT IT FIELDS FOR PROFESSIONAL ENGAGEMENT	133
S. Gračić HETEROGENITY OF ELECTRONIC HEALTHCARE RECORDS AS DRIVING FORCE FOR UNIFYING RDBMS AND NOSQL DATA STORES FOR THE BEST PATIENT-DOCTOR OUTCOMES	137
A. Praskić, V. Srdić, S. Jokić DIDACTIC DESIGN OF MULTIMEDIA AND ITS USAGE IN THE EDUCATIONAL PROCESS	145
I. Trpovski, N. Stojanović, T. Orčić, M. Marković, A. Kovačević, S. Gostojčić RETRIEVING COURT DECISIONS USING TEXT MINING TECHNIQUES AND TOOLS	150
F. Đorđević, A. Kupusinac, D. Ivetić GRAPHIC PROCESSING UNIT PARALLELIZATION OF THE TRAVELING SALESMAN PROBLEM SOLUTION	154
A. Vasiljević, S. Popov AN APPLICATION FOR THE AUTOMATIZATION OF THE WORK REVIEW PROCESS	159
S. Popov, R. Radišić, O. Anđelovski IMPLEMENTING DATA STRUCTURE VISUALIZER FOR TEACHING PURPOSES	163
O. Anđelovski, R. Radišić, S. Popov INTRODUCING THE RUBY PROGRAMMING LANGUAGE INTO EDUCATION	168
S. Popov, R. Mihić SERVICE ORDER EXTENSIONS TO THE OUTAGE MANAGEMENT SYSTEM	173
J. Bondžić, M. Dujović, S. Popov, P. Marić, I. Šećerov USE OF R PROGRAMMING LANGUAGE FOR DROUGHT MONITORING IN VOJVODINA	177
D. Dobrilović, D. Tokody, Ž. Stojanov, M. Malić EXPLORING LORA TECHNOLOGY APPLICATION IN SMART CITIES	181

**International conference on Applied Internet and Information Technologies  
October 3-4, 2019, Zrenjanin, Republic of Serbia**

---

Ž. Stojanov, J. Stojanov, D. Dobrilović QUALITATIVE RESEARCH ON SOFTWARE ENGINEERING INDUSTRIAL PRACTICE: LESSONS LEARNED FROM PREVIOUS STUDIES	187
S. Simić, V. Brtko, V. Jovović, I. Berković, V. Ognjenović MACHINE REINFORCEMENT LEARNING WITH OPENAI GYM	193
V. Ognjenović, M. Jovanović, V. Brtko, I. Berković DATA SCIENCE TOOLS COMPARISON	198
L. Perišić, Lj. Kazi, G. Gecin SECURITY ISSUES IN APPLYING WEB SERVICES WITHIN BUSINESS APPLICATIONS: A CASE STUDY	202
V. Šinik, Ž. Despotović, D. Dobrilović DESIGN AND ANALYSIS OF DC MOTOR USING SOFTWARE TOOL MATLAB SIMULINK	208
V. Šinik, Ž. Janda, B. Jovanović IMPROVED METHODS FOR CONTROL VOLTAGE INVERTERS. ANALYSIS AND SIMULATIONS USING THE SIMCAD SOFTWARE TOOL	215
V. Šinik, Ž. Despotović, D. Dobrilović, G. Gecin POWER SYSTEM ARCHITECTURE FOR SERVERS INTEGRATING ACTIVE, PASSIVE AND EMI-FILTER FUNCTIONS DESIGN	221
Z. Kazi, O. Eskić, B. Radulović WEB APPLICATION FOR EGYPTIAN HIEROGLYPHS DICTIONARY	227
D. Glušac, D. Veselinov, D. Milanov LIFE-LONG LEARNING - MOTIVATION OF COMPANY EMPLOYEES TO ATTEND ONLINE TRAINING	231
N. Ljubojev, M. Zakin -Kavalić, S. Stanisavljev THE RIGHT OF INTERACTIVE COMMUNICATION ON THE INTERNET	236
A. Stojkov, D. Radosav, S. Mihajlović INTERNET USAGE BY CHILDREN UNDER THE TEEN AGE	240
N. Simić, A. Kostić - Zobenica, B. Markoski, V. Premčevski IMPLEMENTATION OF REST WEB SERVICES IN JAVA WEB APPLICATIONS	244
A. Jašić, V. Premčevski, A. Kostić - Zobenica, B. Markoski OFFLINE AVAILABILITY OF DATA	250
S. Mihajlović, Lj. Kazi, B. Radulović INTEROPERABILITY OF DISTRIBUTED BUSINESS WEB APPLICATIONS	256
S. Mihajlović, E. Brtko, V. Brtko WPF APPLICATION DEVELOPMENT ON THE FOOTBALL MATCH EXAMPLE	262
S. Mihajlović, I. Berković APPLICATION AND DIFFERENCE OF RASTER AND VECTOR GRAPHICS	266
M. Bakator, D. Đorđević, D. Čočkalović, S. Bogetić INTERNET MARKETING STRATEGIES AND MANAGING CUSTOMER SATISFACTION	270
M. Bakator, D. Radosav DEVELOPING EFFECTIVE INTERNET MARKETING CAMPAIGNS	274



**International conference on Applied Internet and Information Technologies  
October 3-4, 2019, Zrenjanin, Republic of Serbia**

---

S. S. Sosinskaya, M.V. Porokhova, I.S. Komarov QUALITY COMPARISON OF VARIOUS MACHINE CLASSIFICATION TECHNIQUES	278
A. K. Popova ONLINE SERVICE FOR MODELING FOREST DYNAMICS ON THE GEOPORTAL	283
V.V. Paramonov, A.O. Shigarov, G.M. Ruzhnikov, A.A. Mikhailov, R.K. Fedorov, A.V. Klyuchevskii, V.M. Dem'yanovich INTEGRATION OF HETEROGENEOUS DATA FOR BAIKAL-MONGOLIAN REGION SEISMICITY STUDY	288
N.O. Dorodnykh, A.Yu. Yurin TRANSFORMING CONCEPT MAPS AND SPREADSHEET DATA FOR ONTOLOGY ENGINEERING	293
V.N. Dianov, A.S. Dorofeev, R.S. Dorofeev, E.A. Cherkashin CONSTRUCTING FAULT-TOLERANT AUTONOMOUS SYSTEMS WITH DETECTION OF FAILURE CAUSES	301
V.V. Kopylova, S.S. Ipantjeva, E.A. Cherkashin DEVELOPMENT OF A TOOL FOR VISUALIZATION AND ANALYSIS OF 1C:ENTERPRISE CONFIGURATIONS	306
V. Gebow AN ALGORITHMIC METHOD BASED ON LAPLACE TRANSFORMATION TO IMPROVE THE QUALITY INDICATORS FOR STRAIN GAUGES	311
S. Mihajlović AN OVERVIEW OF SECURITY RISKS IN INFORMATION AND COMMUNICATION SYSTEMS	315
V. Premčevski ROLE OF INTERNET OF THINGS (IOT) IN EDUCATION	321
L. Perišić WEB SERVICES SECURITY: AN OVERVIEW	325
M. Bhatt, S. Bhatt, N. Bhatt, Lj. Kazi, V. Ognjenović EMPOWERING TEACHERS BY ARTIFICIAL INTELLIGENCE –PEDAGOGICAL AGENTS AND CHAT-BOTS	334
<b>APPENDIX</b>	
Organizing and program committee	340
List of reviewers	343
Invited speakers biographies	345
Authors index	349
Conference supporting institutions and companies	353

# INVITED PAPERS

# Artificial Intelligence in Smart Education and Learning Systems: Techniques, Applications and Challenges

Abdel-Badeeh M. Salem

Professor Dr. of Computer Science  
Head of Artificial Intelligence and Knowledge Engineering Research Labs (Shams –AIKE-Labs)  
Faculty of Computer and Information sciences  
Ain Shams University, Cairo, Egypt

<http://staff.asu.edu.eg/Badeeh-Salem> <http://aiasulab.000webhostapp.com/>  
[abmsalem@yahoo.com](mailto:abmsalem@yahoo.com) [absalem@cis.asu.edu.eg](mailto:absalem@cis.asu.edu.eg)

**Abstract** - Artificial Intelligence (AI) is devoted to create intelligent software and hardware that imitates the human mind. The main goal of AI as a science and technology is to make computers smarter by creating intelligent software that will allow a computer to mimic some of the functions of the human brain in selected applications. Applications of AI technology include; general problem solving, data mining and knowledge discovery, expert systems, natural language processing, computer vision, robotics, law, education and healthcare intelligent systems. All of these applications employ knowledge base and inferencing techniques to solve problems and help make decisions in specific domains. Recently, AI paradigms and machine learning (ML) techniques have become more widespread within the fields of E-education and E-learning. Developing of smart education/learning systems is very difficult from the technological perspective and a challenging task. In this paper we focus our discussion around the most efficient AI paradigms and ML used in developing such systems; namely: case-based reasoning, ontological engineering, and data mining. In addition, the paper presents some examples of the developed systems by the author and his colleagues at Artificial Intelligence and Knowledge Engineering Research Labs (Shams –AIKE-Labs) at Ain Shams University, Cairo, Egypt.

**Keywords:** Artificial Intelligence, Knowledge Engineering, Smart Education and Learning Systems, Machine Learning

## I. INTRODUCTION

Smart education and learning (SEL) area is interdisciplinary area of research, encompassing many aspects of the educational technologies that cover instruction, training, teaching, learning, pedagogy, communication and collaboration. SEL systems (SELS) represent a special kind of knowledge-based systems. Such systems permit the knowledge and experience of one or more experts to be captured and stored in its knowledge base. These systems are based on many disciplines such as: cognitive science, computational neuroscience, educational science, artificial intelligence(AI) and knowledge engineering .So, SELs are intelligent systems that imitate the human mind (IeLS). The main characteristics of these systems are the ability of inference, reasoning, perception, learning, and knowledge-based systems. To a limited degree, AI permits SELs to

accept knowledge from human input, and then use that knowledge through simulated thought and reasoning processes to solve problems. Many types of SELs are in existence today and are applies to different domains and tasks, e.g., law, geology, biological sciences, business management, medical sciences, health care, commerce, and education [12, 13, 21, 22].

Based on our analysis of the topics of the World Conferences on Artificial Intelligence in Education (AI-EDU), the research of AI in education and learning consists of nine main areas, namely: intelligent tutoring systems, teaching aspects, learning aspects, cognitive computing and science, knowledge engineering, intelligent tools and shells, educational robotics, multimedia systems and natural language interfaces. In this paper, we focus our discussion on smart education and learning systems (SELS).The paper is organized as follows; the second section introduces an overview of the main aspects of Smart Educational and Learning Systems (SELS). In the third section we present a brief account about the well-known computational intelligent/machine learning techniques which are used in developing and designing the SEL systems in different domains and tasks. Section four presents some applications of SELs developed by the author and his colleagues at Shams-AIEK- Labs in medical domain. The fifth section discusses the difficulties and challenges. The last section draws conclusion and perspectives.

## II. THE MAIN ASPECTS OF SMART EDUCATIONAL AND LEARNING SYSTEMS (SELS)

An SEL system consists of three major components: a knowledge base, an inference engine, and a user interface. The knowledge base contains all the facts, ideas, relationships, and interactions of a narrow domain. The inference engine analyzes the knowledge and draws conclusions from it. This engine (software) uses search and pattern matching techniques on the knowledge base to answer questions, draw conclusions, give recommendations or otherwise perform an intelligent function. The user interface software permits new knowledge to be entered into the knowledge base and implements communication with the user. The purpose of

the system is not to replace the experts, but simply to make their knowledge and experience more widely available. Typically there are more problems to solve than there are experts available to handle them. The system permits others to increase their productivity, improve the quality of their decisions, or simply to solve problems when an expert is not available.

*A. Knowledge representation and management techniques for SELs*

The main challenge in developing IeLS for any specific task is to build a “knowledge base” in that domain of interest. The knowledge of that domain must be collected, codified, organized and arranged in a systematic order. The process of collecting and organizing the knowledge is called knowledge engineering. It is the most difficult and time-consuming stage of any IeLS development process. Figure 1(a) shows some of the static/Hierarchical techniques, e.g.; lists, trees, production rules, semantic networks, frames, scripts, cases, and ontology. Figure 1(b) represents some of the stereotypical knowledge representation techniques. The key to the success of such systems is the selection of the appropriate technique that best fits the domain knowledge and the problem to be solved. That choice is depends on the experience of the knowledge engineer. Further details can be found in [8, 12].

Although a variety of knowledge representation (KR) and management techniques have been developed over the years, these techniques share two common characteristics. First, they can be programmed with certain computer languages and tools. Second, they are designed so that the facts and other knowledge contained within them can be manipulated by an “inference system”, the other major part of an IeLS. The inference system uses search and pattern matching techniques on the knowledge base to answer questions, draw conclusions, or otherwise perform an intelligent function.

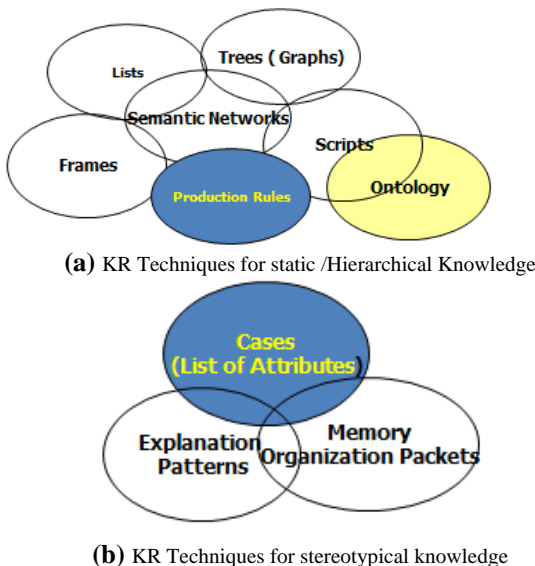

Figure 1. Knowledge representation and management techniques

*B. Reasoning Methodologies for SELs*

The field of reasoning methodologies is very important for the development of SELs software. The research area in this field covers a variety of reasoning methodologies. There are many methodologies and approaches of reasoning e.g.; automated reasoning, case-based reasoning, commonsense reasoning, fuzzy reasoning, geometric reasoning, non-monotonic reasoning, model-based reasoning, probabilistic reasoning, causal reasoning, qualitative reasoning, spatial reasoning and temporal reasoning [13, 17]. Figure 2 shows reasoning methodologies within the knowledge computing and engineering community. In fact these methodologies receive increasing attention within the development of a new generation of intelligent e-Learning systems.

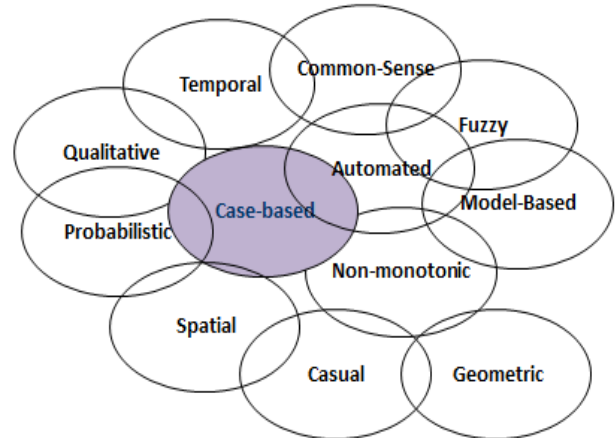

Figure 2. Reasoning methodologies within the knowledge computing and engineering community

**III. MACHINE LEARNING (ML) TECHNIQUES FOR DEVELOPING SEL SYSTEMS**

This section presents a brief account about the well-known ML techniques which are used in developing and designing the SEL systems in different domains and tasks. For more technical details for the informatics point of view, see [13,15,17,18].

*A. Artificial Neural Networks (ANN)*

Artificial neural networks (ANN) are inspired in biological models of brain functioning. They are capable of learning by examples and generalizing the acquired knowledge. Due to these abilities the neural networks are widely used to find out nonlinear relations which otherwise could not be unveiled due to analytical constraints. The learned knowledge is hidden in their structure thus it is not possible to be easily extracted and interpreted. The structure of the multilayered perceptron, i.e. the number of hidden layers and the number of neurons, determines its capacity, while the knowledge about the relations between input and output data is stored in the weights of connections between neurons. The values of weights are updated in the supervised training

process with a set of known and representative values of input – output data samples.

#### *B. Support Vector Machines (SVM)*

SVM are new learning-by example paradigm for classification and regression problems [5]. SVM have demonstrated significant efficiency when compared with neural networks. Their main advantage lies in the structure of the learning algorithm which consists of a constrained quadratic optimization problem (QP), thus avoiding the local minima drawback of NN. The approach has its roots in statistical learning theory (SLT) and provides a way to build “optimum classifiers” according to some optimality criterion that is referred to as the maximal margin criterion. An interesting development in SLT is the introduction of the Vapnik-Chervonenkis (VC) dimension, which is a measure of the complexity of the model. Equipped with a sound mathematical background, support vector machines treat both the problem of how to minimize complexity in the course of learning and how high generalization might be attained. This trade-off between complexity and accuracy led to a range of principles to find the optimal compromise. Vapnik and co-authors' work have shown the generalization to be bounded by the sum of the training error and a term depending on the Vapnik-Chervonenkis (VC) dimension of the learning machine leading to the formulation of the structural risk minimization (SRM) principle. By minimizing this upper bound, which typically depends on the margin of the classifier, the resulting algorithms lead to high generalization in the learning process

#### *C. Clustering*

Clustering techniques apply when the instances of data are to be divided into natural groups. Classical clustering technique is k-means where clusters are specified in advance prior to application of the algorithm. This corresponds to parameter k. Then k points are chosen at random as clusters centers. All instances are assigned to their closest cluster center according to the Euclidian distance metric. Next the centroid, or mean, of each cluster center is calculated. These centroids are taken to be the new cluster centers for their respective clusters. The whole process is repeated with the new cluster centers. Iteration continues until the same points are assigned to each cluster in consecutive runs. At this point the cluster centers have stabilized and will remain the same. There are many variants of clustering even for the kmeans algorithm depending upon the method of choosing the initial centers.

#### *D. Association rule mining*

Association rules mining is one of the most well studied data mining tasks. It discovers relationships among attributes in databases, producing if-then statements concerning attribute-values [7]. An association rule  $X \Rightarrow Y$  expresses that in those transactions in the database

where X occurs; there is a high probability of having Y as well. X and Y are called respectively the antecedent and consequent of the rule. The strength of such a rule is measured by its support and confidence. The confidence of the rule is the percentage of transactions with X in the database that contain the consequent Y also. The support of the rule is the percentage of transactions in the database that contain both the antecedent and the consequent. Association rule mining has been applied to e-learning systems for traditionally association analysis (finding correlations between items in a dataset). An efficient algorithm to discover these association rules was first introduced in [7]. The algorithm constructs a candidate set of frequent item sets of length k, counts the number of occurrences, keeps only the frequent ones, then constructs a candidate set of item sets of length k+1 from the frequent item sets of smaller length. It continues iteratively until no candidate item set can be constructed. In other words, every subset of a frequent item set must also be frequent. The rules are then generated from the frequent item sets with probabilities attached to them indicating the likelihood (called support) that the association occurs. We use this idea of association rules to train our recommender agent to build a model representing the web page access behavior or associations between on-line learning activities.

#### *E. Rough sets (RS)*

Rough set theory was proposed as a new approach to vague concept description from incomplete data. The rough set theory is one of the most useful techniques in many real life applications such as medicine, pharmacology, engineering, banking and market analysis. This theory provides a powerful foundation to reveal and discover important structures in data and to classify complex objects. One of the main advantages of rough set theory is that it does not need any preliminary or additional information about data. At our research unit at Ain Shams, a rough set-based medical system for mining patient data for predictive rules to determine thrombosis disease was developed [8] this system aims to search for patterns specific/sensitive to thrombosis disease. This system reduced the number of attributes that describe the thrombosis disease from 60 to 16 significant attribute in addition to extracting some decision rules, through decision applying decision algorithms, which can help young physicians to predict the thrombosis disease.

#### *F. Genetic Algorithms (GA)*

Many classifications models have been proposed in the literature, such as distributed algorithms, restricted search, data reduction algorithms, parallel algorithms, neural networks and decision trees, genetic algorithms. These approaches either cause loss of accuracy or cannot effectively uncover the data structure. Genetic Algorithms (GA) provide an approach to learning that based loosely

on simulated evolution. The GA methodology hinges on a population of potential solutions, and as such exploits the mechanisms of natural selection well known in evolution. Rather than searching from general to specific hypothesis or from simple to complex GA generates successive hypotheses by repeatedly mutating and recombining parts of the best currently known hypotheses. The GA algorithm operates by iteratively updating a pool of hypotheses (population). One each iteration, old members of the population are evaluated according a fitness function. A new generation is then generated by probabilistically selecting the fittest individuals from the current population. Some of these selected individuals are carried forward into the next generation population others are used as the bases for creating new offspring individuals by applying genetic operations such as crossover and mutation. In our research group we developed a hybrid classifier that integrates the strengths of genetic algorithms and decision trees. The algorithm was applied on a medical database of 20 MB size for predicting thrombosis disease [9]. The results show that our classifier is a very promising tool for thrombosis disease prediction in terms of predictive accuracy.

### G. Case-Based Reasoning (CBR)

CBR is an analogical reasoning method provides both a methodology for problem solving and a cognitive model of people [15]. CBR means reasoning from experiences or "old cases" in an effort to solve problems, critique solutions, and explain anomalous situations. It is consistent with much that psychologist have observed in the natural problem solving that people do. People tend to be comfortable using CBR methodology for decision making, in dynamically changing situations and other situations were much is unknown and when solutions are not clear.

From knowledge engineering point of view, the "case" is a list of features that lead to a particular outcome. (e.g. The information on a patient history and the associated diagnosis). Figure 3 shows an example of a "Liver cancer case". Determining the appropriate case features is the main knowledge engineering task in case-based AI software. This task involves defining the terminology of the domain and gathering representative cases of problem solving by the expert. Determining the appropriate case features is the main knowledge engineering task in developing case-based SELs. This task involves defining the terminology of the domain and gathering representative cases of problem solving by the experts. Representation of cases can be in any of several forms (predicate, frames, scribes). From the computational point of view, CBR refers to a number of algorithms and techniques useful in solving new cases when they are presented. In addition, there are techniques that can be used to modify earlier cases to better match new cases and other techniques to synthesize new cases when they are needed. CBR has already been applied in a number of

different applications in many domains ,e.g. , medicine, industry, law, banking [ 10,11,15 ].

**Patient:** 65-years old female not working, with nausea and vomiting.

**Medical History:** cancer head of pancreas

**Physical Exam:** tender hepatomegaly liver, large amount of inflammatory about 3 liters, multiple liver pyogenic abscesses and large pancreatic head mass.

**Laboratory Findings:** total bilirubin 1.3 mg/dl, direct bilirubin 0.4 mg/dl, sgpt (ast) 28 IU/L, sgpt (alt) 26 IU/L.

Figure. 3 Example of a "liver cancer case" description

The methodology of CBR is becoming popular in developing case-based SEL systems (CBR-SELs) because it automates applications that are based on precedent or that contain incomplete causal models [15]. In a RB-SEL system an incomplete model or an environment which does not take into account all variables could result in either an answer built on incomplete data or simply no answer at all. Case-based methodologies attempt to get around this shortcoming by inputting and analyzing problem data, then retrieving a similar case from the case memory library, and finally displaying a solution based on examination of these previous cases.

The CBR-SELs uses an extensive case-based of exercises and examples to teach students. The CBR-SELs solve new problems by adapting solutions that were used for previous and similar problems. The methodology of CBR-SELs can be summarized in the following steps:

1. The system will search its case-memory for an existing case that matches the input problem specification.
2. If we are lucky (our luck increases as we add new cases to the system), we will find a case that exactly matches the input problem and goes directly to a solution.
3. If we are not lucky, we will retrieve a case that is similar to our input situation but not entirely appropriate to provide as a completed solution.
4. The system must find and modify small portions of the retrieved case that do not meet the input specification. This process is called "case-adaptation".
5. The result of case adaptation process is (a) completed solution, and (b) generates a new case that can be automatically added to the system's case-memory for future use.

Research reveals that users learn best when they are presented with examples of problem-solving knowledge and are then required to apply the knowledge to real situations. The case-memory of examples and exercises capture realistic problem-solving situations and presents them to the learners as virtual simulations.

On the other hand, there are several benefits where students/learners should be able to perform better using CBR methodology, e.g.,

1. With more cases available, students will be able to recognize more situations and the solutions that go with these cases include failure cases, students will be able to benefit from the failures of others.
2. Retrieval cases will allow students to better recognize what is important in a new situation. Cases indexed by experts would recall and will show the student ways of looking at a problem that he might not have the expertise for without the system .
3. Student will have access to obscure cases that they otherwise would not be able to make use of. These obscure cases can help with any of the tasks previously listed.
4. During a training period CBR system provides the student with a model of the way decision making ought to be done, for example, what things ought to be considered and provides them with concrete examples on which to hang their more abstract knowledge.
5. For tasks where there is much to remember, CBR systems can augment the memories of even educators. Also, both educators and students tend to focus on too few possibilities when reasoning analogically or to focus on the wrong cases.

#### *H. Ontological Engineering (OE) Approach*

The term “ontology” is inherited from philosophy, in which it is a branch of metaphysics concerned with the nature of being. The main objective of using ontologies is to share knowledge between computers or computers and human. Computers are capable to transmit and present the information stored in files with different formats, but they are not yet compatible to interpret them. To facilitate communication and intelligent processing of information, it is necessary that all actors of the digital space (computers and humans) have the same vocabulary. Ontologies are the foundation of cooperation and the semantical understanding between computers (running a lot of nonhomogenous software programs) and of the cooperation between computers and humans[25].

Most of the usages of ontologies in the field of computer science are related to knowledge based systems and intelligent systems. These types of ontologies include a small number of concepts and their main objective is to facilitate reasoning. For example, in a multi-agent systems, the knowledge representation is accomplished through a basic ontology, private ontologies and a knowledge base. Private ontologies of the agents are derived from the basic ontology. The names of the concepts used in private ontologies of the agents are unknown, but their definitions use terms from the basic ontology. During the last decade, increasing attention has been focused on ontologies [4, 14]. At present, there are applications of ontologies with commercial, industrial, medical, academic and research focuses [7, 20].

Ontologies' usage in educational systems may be approached from various points of view: as a common vocabulary for multi-agent system, as a chain between heterogeneous educational systems, ontologies for pedagogical resources sharing or for sharing data and ontologies used to mediate the search of the learning materials on the internet[23].

The abstract specification of a system is composed of functional interconnected elements. These elements communicate using an interface and a common vocabulary. The online instructional process can be implemented successfully using artificial Intelligence techniques. Sophisticated software programs with the following features give the intelligence of the machine: adaptability, flexibility. Learning capacity, reactive capacity, autonomy, collaboration and understanding capacity. This approach enables to solve the complexity and the uncertainty of the instructional systems. An intelligent learning system based on a multi-agent approach consists in a set of intelligent agents, which have to communicate. They collaborate through messages. Software agents can understand and interpret the messages due to a common ontology or the interoperability of the private ontologies.

#### *I. Data Mining Methodology for Developing SELs*

Data mining methodology aims to extract useful knowledge and discover some hidden patterns from huge amount of databases which statistical approaches cannot discover. It is a multidisciplinary field of research includes: machine learning, databases, statistics, expert systems, visualization, high performance computing, rough sets, fuzzy logic, neural networks, and knowledge representation. Data mining techniques aim at providing intelligent computational methods for accumulating, changing and updating knowledge in intelligent systems, and in particular learning mechanisms that will help us to induce knowledge from information or data.

Knowledge discovery in databases (KDD) process involves the following processes; (a) using the database along with any required selection, preprocessing, sub-sampling, and transformations of it, (b) applying data mining methods (algorithms) to enumerate patterns from it, and (c) evaluating the products of data mining to identify the subset of the enumerated patterns deemed knowledge. The data mining components of the KDD process is concerned with the algorithmic means by which patterns are extracted and enumerated from data. The overall KDD process includes the evaluation and possible interpretation of the mined patterns to determine which patterns can be considered new knowledge. Data mining is supported by a host that captures the character of data in several different ways, e.g. clustering, classification, link analysis, sequence analysis, regression models, summarization, text mining, sequential pattern mining, association rules mining. In addition there are a lot of intelligent techniques to perform these tasks e.g. neural networks, support vector machines, decision trees, genetic algorithms, k-means and others. For more details we refer to the books [13,18].

#### *1) Benefits of data mining methods to smart education and learning*

This section presents the applications of some of the data mining methods and tasks in e-learning and education domains. Further details and other applications can be found in [2].

##### *a) Information Visualization in e-Learning*

Information visualization (IV) can be used to graphically render complex, multidimensional student tracking data collected by web-based learning/educational systems. The IV in e-learning can be used in the following educational tasks; admitted questions, complementary assignments, exam scores, etc. Moreover visualization tools (e.g., GISMO CourseVis) enable instructors to manipulate the graphical representations generated, which allow them to gain an understanding of their learners and become aware of what is happening in distance classes.

##### *b) Clustering in e-Learning*

Clustering approach has been used in e-Learning for the following tasks:

- Finding clusters of students with similar learning characteristics and to promote group-based collaborative learning as well as to provide incremental learner diagnosis.
- Discovering patterns reflecting user behaviors and for collaboration management to characterize similar behavior groups in unstructured collaboration spaces.
- Grouping students and personalized itineraries for courses based on learning objects.

- Grouping students in order to give them differentiated guiding according to their skills and other characteristics.
- Grouping tests and questions into related groups based on the data in the score matrix.
- Grouping users based on the time-framed navigation sessions.

##### *c) Classification in e-Learning*

In e-learning, classification has been used for:

- Discovering potential student groups with similar characteristics and reactions to a specific pedagogical strategy.
- Predicting students' performance and their final grade.
- Detecting students' misuse or students playing around.
- Grouping students as hint-driven or failure-driven and finding students' common misconceptions.
- Identifying learners with little motivation and finding remedial actions in order to lower drop-out rates.
- Predicting course success

#### *J. Agent-Based Approaches for SEL*

Intelligent agents (IAs) are artificial entities that have several intelligent features, such as being autonomous, responding adequately to changes in their environment, persistently pursuing goals, flexible, robust, and social by interacting with other agents. IA mimics human interaction types, such as negotiation, coordination, cooperation, and teamwork. As are defined as computer systems situated in an environment and that are able to achieve their objectives by: (i) acting autonomously, i.e. by deciding themselves what to do, and (ii) being sociable, i.e. by interacting with other software agents. Agents are often seen as incarnations of various forms of AI including machine learning, reasoning and data mining. Research interests in agent systems are spanning various topics like modeling, design and development of advanced software systems that are appealing for a number of computer applications [19].

During the last decade, agent technologies were proposed to enhance e-learning systems across at least two dimensions: (i) agents as a modeling and design paradigm for advanced human-computer interaction and (ii) agents for smart functional decomposition of complex systems.

Firstly, agents have been described as entities that exhibit several interesting properties that are very appealing for the modeling and design of advanced user interfaces encountered in e-learning systems: teachers, tutors and students.



Secondly, generic agent types proven to be effective for the appropriate functional decomposition of e-learning systems. Dynamic and interoperability characteristics of agents are very suitable for supporting maintainability and extensibility of e-learning systems.

#### IV. SOME APPLICATIONS OF SELS IN MEDICAL DOMAIN

Table (1) presents some of SELs developed at Shams-AIKE-Labs, Computer Science Department, Ain Shams University, Cairo. Further details of each system/tool can be found in the corresponding reference.

Table 1: Some of examples developed by the author and his colleagues at Shams-AIKE-Labs.

eLearning Tool	Type	Task/Purpose	AI Methodology/Technology	&	[Reference]
BreastON	Web-based Ontology	Designed to show the relationship between related terms/knowledge of breast cancer	OWL-DL Protégé-OWL environment	&	[4]
LungON	Web-Based Ontology	Designed to show the relationship between related terms of Lung Cancer	OWL-DL Protégé-OWL environment	&	[5]
LiverON	Web-Based Ontology	Designed to show the relationship between related terms of Liver Cancer	OWL-DL Protégé-OWL environment	&	[6]
ViralHON	Web-Based Ontology	to show the classes of the Viral Hepatitis Diseases Classification Tree(A,B,C and D )	Ontology of Biomedical Reality (OBR) framework	&	[14]
BreastClass	Classification System	to classify the patient based on his/her electronic record whether he/she is benign or malignant. Breast cancer	Combination of CBR and ontological engineering	&	[11]
CancerRES	Expert System	Cancer diagnosis	Production Rules		[3]
CancerCES	Expert System	Cancer diagnosis	Case-Based Reasoning		[3]
HeartRES	Expert System	Diagnosis of heart diseases	Production Rules		[10]
HeartCES	Expert System	Diagnosis of heart diseases	Case-Based Reasoning		[10]
ThrombDM	Data Mining System	To determine the Thrombosis and helps young physicians to predict the thrombosis disease.	Rough Sets		[9]
BrainTClass	Classification System	Brain Tumor diagnosis (acoustic neuroma, astrocytomas, optic glioma)	Hybrid Neural Netwks (PCA+MLP)		[16]
ECGI	ElectrocardiogramIdentification System	User(student/tutor) authentication / identification	Behavioral Biometrics		[23]
EEGI	Electroencephalography Identification System	User(student/tutor) authentication / identification	Behavioral Biometrics		[24]

In what follows a brief overview about some of our applications. Further details about the technical and computing aspects of these systems can be found in our published articles [3, 4, 9].

##### 1. Case-Based Reasoning for Diagnosis of Cancer Diseases

The system's knowledge base was constructed from actual case histories and includes 70 cancer patient cases; some

are real Egyptian cases and some from virtual hospitals on the internet. The computational model uses rule-based inference to give diagnostic decision and new case is stored in case library. Patient cases are retrieved in dialogue with similarity matches using the nearest neighbor matching technique. The system provides recommendation for controlling pain. It can be used as a tool to aid and hopefully improve the quality of care given for those suffering intractable pain. The system is very useful in the management of the problem, and assists the young physicians to check their diagnosis. Further details of the system's technical aspects can be found in [3].

##### 2. Web-Based Breast Cancer Ontology

The breast cancer ontology was encoded in OWL-DL format using the Protégé-OWL editing environment [4]. The knowledge was collected from: MedicineNet, World Health Organization [8], breastcancer.org, ehealthMD and National Comprehensive Cancer Network. In this ontology we have two main super classes ;(a) MedicalThings which has sub classes Diseases, Medical\_Interventions, Pathological\_Category, References, and (b) People which has the sub classes; men and women. Our results indicate that, the breast cancer is described in terms of its symptoms, causes, stages, pathological category, diagnosis and treatment. In this context, we described causes, stages, and symptoms as references. While diagnosis and treatment are described as medical interventions. The main benefits from this ontology are to allow finding and locating information about breast cancer needed for interested users and domain experts.

##### 3. Mining Patient Data Using Rough Sets

In [9], a rough set-based medical system for mining patient data for predictive rules to determine thrombosis disease was developed. The system aims to search for patterns specific/sensitive to thrombosis disease. The rough sets was applied on medical data base of 20 MB. The results show that the number of attributes that describe the thrombosis disease was reduced from 60 to 16 significant attribute. In addition the system extracts some useful decision rules which can help young physicians to predict the thrombosis disease.

#### V. CHALLENGES

The development of intellectual e-Learning systems is a very difficult and complex process that raises a lot of technological and research challenges that have to be addressed in an interdisciplinary way. The IeLSs face the following difficulties and challenges

1-The knowledge-acquisition difficulty: Valuable knowledge is a major resource and it often lies with only a few experts. It is important to capture that knowledge so others can use it. Experts die, retire, get sick, move on to

other fields, and otherwise become unavailable. Thus the knowledge is lost. Books can capture some knowledge, but they leave the problem of application up to the reader. Case-Based reasoning methodology addresses this problem, where it is easier to articulate, examine, and evaluate cases than rules.

2- Maintenance difficulties: IeLSs are complex to build and complex to maintain. CBR methodology addresses this problem, where maintaining case-based eLearning system is easier than rule-based e-Learning system since adding new knowledge can be as simple as adding a new case.

3- Performance experience: Productivity of IeLS development is determined by the efficiency of their knowledge representation techniques and reasoning methodologies. The key to the success of such systems is the selection of the appropriate technique and methodology that best fits the domain knowledge and the problem to be solved. That choice depends on the experience of the knowledge engineer. A case-based e-Learning system can remember its own performance, and can modify its behavior to avoid repeating prior mistakes. By reasoning from analogy with past cases, a CBR system should be able to construct solutions to novel problems.

## VI. CONCLUSIONS AND FUTURE WORK

Knowledge computing, machine learning, computational intelligence and data mining paradigms give smart education and learning systems added intelligence capabilities, allowing them to exhibit more intelligent behavior. These paradigms offer robust computational techniques for accumulating, updating, managing and representing knowledge. These techniques enable users with learning mechanisms that help to induce knowledge from raw data. Data mining techniques enable users with learning mechanisms that help to induce knowledge from raw data. Ontological engineering offers a promising way to develop efficient e-learning systems capable to facilitate knowledge sharing, refine, search, and reuse. Moreover, the convergence of AI, data science, ML, educational technology and internet of things (IoT) is enabling the creation of a new generation of web-based intelligent e-learning and tutoring systems. The web based of such systems can enhance the online learning/training/education processes.

Among the envisaged directions for future work we include: (i) using the behavioral biometrics technology for user authentication / identification (this technology is based on the user data of electrocardiogram and electroencephalogram bio-signals); (ii) the investigation of using ontological engineering approach in developing SELs that provide learners with intelligent browsing and searching support in their request for relevant material on the web and (iii) using the distributed artificial intelligence methodology in developing a new versions of smart

educational and learning systems as an open intelligent information systems.

## REFERENCES

- [1] Abdel-Badeeh M. Salem, "Intellectual E-Learning Systems", Proc. Of the Annual International Conference on "Virtual and Augmented Reality in Education" (VARE 2011) (combined with EEA and Norwegian Financial Instruments project practical conference "VR/AR Applications in Training"), Vidzeme University of Applied Sciences, Valmiera, Latvia, PP 16-23, March 2011.
- [2] Abdel-Badeeh M. Salem, Data Mining Technology in e-Learning, Proceedings of 6th International Conference on Emerging e-learning Technologies and Applications, Information and Communication Technologies in Learning, (ICETA2008), Stara Lesna, The High Tatras, Slovakia, 2008.
- [3] Abdel-Badeeh M. Salem, M. Roushdy, B. M. El Bagoory, An Expert System for Diagnosing Cancer Diseases, MENDEL 2001, Proc. of 7th international Conference on Soft Computing, Brno University of Technology, Czech Republic, pp. 300-305, 2001.
- [4] Abdel-Badeeh M. Salem, Marco Alfonse, "Ontological Engineering Approach for Breast Cancer Knowledge Management". Proc. of Med-e-Tel, the International eHealth, Telemedicine and Health ICT for Education, Networking and Business. PP 320-324, Luxembourg, March 30 – April 5, 2009.
- [5] Abdel-Badeeh M. Salem, Marco Alfonse, Building Web-Based Lung Cancer Ontology, The International Journal of Soft Computing Applications, ISSN: 1453-2277 Issue 2, PP 5-14, 2008.
- [6] Marco Alfonse, Mostafa M. Aref, Abdel-Badeeh M. Salem, "Ontology-Based Knowledge Representation for Liver Cancer", Proceedings of the International eHealth, Telemedicine and Health ICT Forum for Educational, Networking and Business. Luxembourg, G. D. of Luxembourg, ISSN 1818 – 9334, PP: 821-825, April 18-20, 2012.
- [7] Abdel-Badeeh M. Salem, Ontological Engineering in e-Learning, Proceedings of 8th International Conference on Emerging e-learning Technologies and Applications, Information and Communication Technologies in Learning, (ICETA2010), Stara Lesna, The High Tatras, Slovakia, 2010.
- [8] Abdel-Badeeh M. Salem, The Role of Artificial Intelligence Technology in Education, Proceedings of 5th International Conference on Emerging e-learning Technologies and Applications, Information and Communication Technologies in Learning, ICETA, The High Tatras, Slovakia, PP 1-9, 2007.
- [9] Abdel-Badeeh M. Salem, Mohamed Roushdy and Safia A. Mahmoud, Mining Patient Data Based on Rough Set Theory To Determine Thrombosis Disease, International Journal On Artificial Intelligence and Machine Learning, AIML, Tubungen, Germany, Vol. 1, PP.27-31, 2004.
- [10] Abdel-Badeeh M. Salem, Rania A. Hodhod, "Developing a Hybrid Expert System Prototype for Diagnosis of Heart Diseases", Proceedings of IFIP 17th World Computer Congress, Stream 8: IIP 2002 Intelligent Information Processing, Montreal, Canada, August, 20-30, Poster Presentation, 2002.
- [11] Abdrabou, E. A. M. & Salem, A. B., "A Breast Cancer Classifier based on a Combination of Case-Based Reasoning and Ontology Approach", Proc. of 2nd International Multi-conference on Computer Science and Information Technology. IMCSIT 2010, Wisla, Poland, 2010.
- [12] Greer, J. Proceedings of AI-ED 95, World Conference on Artificial Intelligence in Education, Association for Advancement of Computing in Education (AACE), 1995.
- [13] I. H. Witten and E. Frank, Data Mining – Practical Machine Learning Tools and Techniques. 2nd ed, Elsevier, 2005.
- [14] Ibrahim F. Moawad, Galal AL Marzouqi, Abdel-Badeeh M. Salem, "Building OBR-based OWL Ontology for Viral Hepatitis", Egyptian Computer Science Journal, ECS, Vol. 36 No. 1, PP 89-98, 2012

- [15] Kolonder, J., Case-Based Reasoning, Morgan Kaufmann, 1993.
- [16] M.F Tolba, A.M. Salem and S.E Amin , “Brain Tumor Classification Based on MRI Using Neural Networks “, International Journal of Intelligent Computing & Information Sciences, Volume 2, Number 2, pp. 48-57, July 2002.
- [17] Pawlak Z., Rough Sets: Theoretical Aspects of Reasoning about Data, Kluwer Academic Publishers, Dordrecht, 1991.
- [18] Romero, C., & Ventura, S. Data mining in e-learning. Southampton, UK: Wit Press 2006.
- [19] Rosa M. Viccari, Demetrio A. Ovalle, Jovani A. Jim´enez, ALLEGRO:Teaching/Learning Multi-Agent Environment using Instructional Planning and Cases- Based Reasoning (CBR) CLEI ELECTRONIC JOURNAL, VOLUME 10, NUMBER 1, PAPER 4, JUNE 2007
- [20] Sarma Cakula, Abdel-Badeeh M. Salem, “ONTOLOGY-BASED COLLABORATIVE MODEL FOR E-Learning“, Proc.of the Annual Int Conf on"Virtual and Augmented Reality in Education" (VARE 2011) (combined with EEA and Norwegian Financial Instruments project practical conference"VR/AR Applications in Training"), Vidzeme University of Applied Sciences, Valmiera, Latvia,PP 98-105, 18 March 2011.
- [21] SALEM, A.-B. M. and PARUSHEVA, S. DEVELOPING A WEB-BASED ONTOLOGY FOR E-BUSINESS. *International Journal of Electronic Commerce Studies*, Vol. 9, No. 2, pp .119-132., 2018a.
- [22] SALEM, A.-B. M. and PARUSHEVA, S. Exploiting the knowledge engineering paradigms for designing smart learning systems. *EasternEuropean Journal of Enterprise Technologies*, Vol. 2, Issue: 33635, pp. 38-44, 2018b.
- [23] Tantawi, M., Revett, K., Tolba, M. F. and Salem, A., “ECG based Biometric Recognition using Wavelets and RBF Neural Network”, Proceedings of the 7th European Computing Conference (ECC'13), pp. 100-105, 2013.
- [24] Wael H. Khalifa, Mohamed I. Roushdy, Abdel-Badeeh M. Salem “User Identification System Based on EEG Signals”; In proceeding of: The Sixth International Conference on Intelligent Computing and Information Systems, Cairo, Egypt, PP 262-267 ,2013
- [25] X. Su and L. Ilebrekke, A Comparative Study of Ontology Languages and Tools, Proceedings of the 14th Conf. on Advanced Information Systems Engineering (CAiSE'02), Toronto, Canada, 2002.

# A Prototype of a System for E-Learning

Stoyan Cheresharov, Kremena Stefanova, Ivan Jelev and Veselina Naneva

Plovdiv University "Paisii Hilendarski", Plovdiv, Bulgaria

stoyancheresharov@gmail.com, kvstefanova@gmail.com, nvjcompany@gmail.com, naneva140156@gmail.com

**Abstract:** During the rapid development of information technology, the models and techniques of learning undergo daily changes. Each university should provide accurate tools for learning both in the classroom and remotely. There are a large number of websites and platforms that organize the learning process and can be used by both teachers and students. However, the educational process is a closed cycle and it covers the phase of applying to the university, goes through the years of studying and ends with the successful career realization of students. If a university wants to use an educational platform, it can implement an existing one or develop its own. Some of the advantages of the custom solution are, for instance, that it satisfies the specific requirements and there is no need of modification. The paper suggests a prototype of an e-learning platform which can be used in higher education. It supports the communication and the educational process of student and teacher, inside and outside the university. Also, it has a module which is focused on the connection between students and the business representatives.

**Keywords:** *learning management system, communication, university environment*

## I. INTRODUCTION

During the rapid development of information technology, the application of automated processes is noticeable in all spheres of human activity. It is extremely important for the modern person to receive quality and affordable learning. Alongside a variety of work and entertainment platforms, many web-based learning management systems have emerged. Such platforms fully satisfy the so-called e-learning. Its main purpose is to transmit specific content to a particular group or individual on their preferred devices at a time chosen by them. Facilitated monitoring of personal progress, bilateral analysis and the visibility of the learning process, by both teachers and students, makes the introduction of ICT into science a priority for educational institutions. E-learning is classified according to the type of teaching material delivered, the employment of teachers and students, as well as the applied pedagogical techniques.

Statistically speaking, traditional learning is still applicable as a way of teaching – face-to-face learning, according to a specific structure and program. The commitment of professionals and students makes in-person training time-consuming and less adequate for the modern age of computerization. On the other hand, the implementation of e-learning only would lead to a loss of communication with the teachers, making it difficult for

the students to practice the assimilated material completely in Internet.

Combining face-to-face and online types of learning would reap the benefits of both methods, creating a single specialized technique that provides all the necessary ways for students to access ICT resources, teachers and important communications. The technique is known as Blended Learning, characterized by traditional teaching methods such as live-based classroom teaching and blending of online learning through group work, individual testing and self-study and administration of learning resources. It is precisely because of the advantages of Hybrid Learning that it is of the utmost importance to build a system that fully satisfies the specificities of the relevant scope and to give students and teachers access to qualitative education.

## II. PERSPECTIVES OF E-LEARNING

In the field of learning, the quality of the material taught can be improved in many ways. From a pedagogical point of view, there are specific tools for influencing the student's interest as well as for organizing the entire study material. However, in the age of information technology, the use of electronic systems, tools and development environments is increasingly prevalent as a primary or complementary learning tool. The modern students are mobile, seeking knowledge from the internet, and want to improve their skills by using their free time outside of university or work. Thus, the main types of teaching models should be considered, as they would represent the overall need of a student for personalized learning.

From the point of view of the relationship between teacher and student, it is appropriate to consider two basic behaviors in a generalized communication model [1]. They could be classified as static and dynamic depending on the type of participation in the model in question. The linear model is shaped as an approach for transmitting information from the teacher himself to the student, which largely implies one-way communication. The student follows a pre-built program and is entitled to questions after the module material is completed. In the interactive learning model, there are two parallel linear models that communicate with each other. The timing, sequence and amount of information is determined by the student, enabling the teacher himself to take feedback on the assimilation of the material. Unlike the linear model, in which we have a passive form of learning, there is clearly active communication in the interactive one.

Each person's learning is a long process, regardless of the material studied. Often the time at university is not enough for everyone to learn and the student has to practice at home what he has learned. There are two models of learning divided by the time each student can devote to his education. They are fully tailored to the abilities of the teachers and students, and again they can be used in parallel to achieve a better quality result. Synchronous learning is entirely a traditional education. It is a method of teaching organized according to a specific curriculum, which is known in advance by both the teacher and the students. This program cannot be changed and students are fully in tune with the time of the classes. Asynchronous learning, on the other hand, is dynamic learning. Mainly it is applied to students with distance learning or to those who want to prepare themselves additionally. Usually, participants agree with each other when the classes will be held, how long they will be held, and what material will be covered for the relevant time. Often, the two learning models – synchronous and asynchronous – are applied in combination so that the necessary material is practiced and learned as much as possible.

From psychological point of view, the education of each student is divided into two approaches – presentation of the material in a personal lesson and in the form of group work [3]. Often, in traditional learning, personal teaching cannot be considered, as there are usually more people in the universities, but the collaborative approach is often used in case of assessment, essays, etc. Joining more than one person in a study project aims to develop not only the student's practical skills in the discipline, but also to improve his or her ability to collaborate in a team, solve mass issues and problems, or to be a leader/group member. Individual training is a type of traditional learning. With the introduction of ICT, there are widely used interactive whiteboards and multimedia files. Despite the availability of infographics and digital resources, individual training remained uncompetitive for students who had to study remotely or to distribute course material. Collective learning is a situation where two or more people learn something together. Collaborative learning is a prerequisite for easier and quicker absorption of material; it exchanges ideas and observations as a team. In this way, the teacher can assign a team task in order to exercise the team competences of the participants, the ability to solve problems and to apply their analytical thinking.

It is well known that one of the most important things in learning is the educational content [4]. It can be presented in various ways, through media files, presentations and infographics, or traditionally with tutorials and exercise books. It is important to note that each student needs a different time to learn the material and it is appropriate to consider an option in which he or she can obtain the necessary knowledge synthesized. Fixed learning content is a technique that adheres to traditional learning. A feature is predefined and coherent with the curriculum content. The materials are precisely defined for the whole period of study regardless of the level of students. Adapted content of the course material is

seen as an innovative approach, but is increasingly being introduced as an alternative to the previous type. From a teacher's point of view, this technique is trickier, since one has to constantly monitor the level of perception of information, to carry out tests and to analyze them. On the other hand, it is the perfect teaching method for a student as it offers the opportunity to obtain accurate and synthesized learning content.

Depending on the employment of each student, it is necessary to consider individual forms of learning. Classroom learning is one of the most ancient forms of education. In order to apply the available information technologies, presentations to the audience and interactive whiteboards have been successfully integrated. Students can gain knowledge through direct communication with the tutor as well as exchange ideas with their classmates. The disadvantage is the presence of misunderstood material that cannot be exercised on time in the classroom. In contrast to learning in the physical location, distance learning is characterized by the opportunity students to gain additional or recapitulate prior knowledge. The advantage of this method is that the student is not limited in time, place and learning and can access a lesson even through his mobile phone. Communication with others is a disadvantage as the teaching cycle remains open and direct teacher involvement is lacking. The hybrid method of teaching benefits from the two previous techniques, giving students the right to choose exactly how to access their material. Students' communication opportunities are shared with their colleagues and teachers, both live and online.

The main trends of e-learning are created as separate defined techniques for transmitting information. The specification of having the necessary information make it possible for the teacher to combine some of the techniques into one indivisible level. The first principle is Microlearning. Despite of traditional e-learning, in the microteaching range, the provided information is in small portions and should be used at the level of student's assimilation. Accordingly, if the material is not accepted, the subsequent granular data will not be provided. This training course can be applied to students, who attend more than one learning institution, to working people who seek new knowledge, or people who may take some time to learn new material. The main users of this technique are able to maintain distance learning and use mobile devices. Their self-study vision comes with access to the maximum knowledge and no limitation about time.

Artificial intelligence [2] has already gained a lot of popularity and is now being introduced as means of transmitting information in the field of e-learning. Another advantage of personalized information is that artificial intelligence analyzes the participation of everyone by collecting and processing the necessary information for students' performances and weaknesses. This will automate the attempt to get to know a particular individual and might recommend adequate and interesting training for him/her. We could view artificial intelligence as content presented in the following ways:

- Intelligent content – recommended organized learning content in digital form with synthesized information. The materials used for the specific module can be presented in the form of short-contented questions, a digital manual or a smart guide. In this way, the student can learn its intelligent system, select a certain material, or present their media gallery so he or she can receive a personalized learning content.
- Intelligent learning systems – intelligent learning systems, platform presentations or entire software products designed to provide the most personalized information. Each participant needs different time to understand daily material. When using artificial intelligence, the training platform adapts to the user who uses it and has the power to present the same information in a different individual way. For a student who has difficulties to grasp two modules, he/she receives a third one related to the corresponding gaps.

Mobile learning is another option of e-learning. Mobile devices completely conquer the life of a modern man. The applications that are installed on smartphones largely determine our daily lives and it is crucial to provide clear and meaningful information to every student. One of the disadvantages of mobile learning is its need of Internet connection. That is way it should be created local learning content that can be accessed on a personal device along with the installation of the application itself. All content included in the mobile app training method could be borrowed from previous.

Video learning is also a technique used in e-learning. It is based on audio and visual perception of the learning material, thus clearly presenting difficult to digest data. Especially in highly theoretical disciplines where the applied aspect is poor, video learning enables students to acquire knowledge that would otherwise be rejected. From a teachers' point of view, this method is difficult because they have to properly choose the material which can be presented in video form. It is noted that short videos with basic material that are tied under a common playlist to the whole discipline are much preferred over long materials that contain the entire course content.

A number of options are common for a student to contact their teacher or a representative of the university administration. There is a traditional live connection where the student seeks out his teacher in his counseling classes and exchanges views and advice there. On the other hand, the teacher could again inform the students through face-to-face contacts about upcoming events or learning activities. In the age of information technology, however, it is increasingly necessary to implement systems that allow indirect communication at the teacher-student level. Such software products are the so-called relationship management systems. CRM systems for education are specialized software, tailored to manage the interconnection processes in the educational institution, covering not only communication with students, but also notification of their admission, learning, testing, reporting and analysis, and conducting surveys [5]. As all of these

characteristics are listed and there are specific IT tools to work with, it is best to consider them as separate modules in order to define their relevance to the whole system. The university as an institution is committed to answering all inquiries from both current students and future ones. In the modern age of computerization, it is imperative to pay attention to the adaptability of communication in terms of speed of process, accessibility for different devices and ease of operation. A CRM software can easily be tied to emails, telephones and mobile applications to deliver a wide range of communication. In addition to being a communication tool, the CRM product can also be seen as means of getting to know students. By updating their profiles, students would successfully introduce their interests, skills and preferences so that the teacher would be able to classify his or her students by interests and provide more focused and intriguing knowledge. By building a such kind of system, automation of manual tasks and connections can be successfully achieved. If we take into account the questions asked, artificial intelligence can be integrated to guide the student during his/her work with the system and, if necessary, enable them to contact a teacher or administration department. Last but not least, the need for timely communication should be considered. Each university has an administration department that is responsible for different notices related to conducting classes, exams, events or other announcements. The integration of timely announcements in the system will greatly bind students to their learning environment and provide the necessary convenience.

Each learning institution aims to develop successful professionals who can apply their knowledge in their career. That is why it should be considered an option, using the opportunities of information technology to provide a clear structure for students and business people to meet [6]. Currently, students can use a text editor or other software to create CVs with built-in templates. On the other hand, social networks and job-finding sites are already very popular. They usually introduce skills, competencies, work and educational history and follow a specialized business logic. However, these platforms are targeted at a wide range of people and follow the principle of searching for a specialist by specific criteria. The individual presentation is poorly affected. It is important also to be considered portfolio building systems. They are software products that represent to employers the application skills of a candidate. The question for professionals is how to make sure that the corresponding candidate possesses those skills that are specified in the system and the portfolio projects are his or her own.

Students are given the opportunity to integrate themselves into the work environment by sending CVs, portfolios and inquiries so that they can engage their employers. In order to be competitive, every student should take care of their education on a daily basis, which in turn means inevitably getting home study, accessing additional resources and learning on her/his own. It is because of this fact that the learning cycle is not limited to the university and the faculty, but is linked to the application itself and continues until a suitable job is

found. It is of the utmost importance that every teacher should pay attention to his/her student both in terms of the questions being asked and the correctness of the applied projects.

### III. DESCRIPTION OF THE PROTOTYPE

In this section we will introduce the designed prototype of a e-learning system which can be integrated in higher education schools. In order to characterize the prototyped system with all the available advantages of the mentioned methods of teaching in e-learning, it should be given a general reading of its specifics. In addition to cover all aspects of student experience, the system imposes characteristics of both CRM system and educational software. In connection with career realization, there is a special type of system users for business representatives. Thus, a company will be able to reach a certain future candidate. The method of communication is concerned as asynchronous, in which students can simultaneously receive and seek information from the teacher. On the other hand, from a content point of view, it is adapted to be smart and dynamic, so that all innovative information technology tools can be implemented. In particular, student behavior is viewed as hybrid software or blended learning. Students can simultaneously acquire knowledge from their classroom teacher and self-study through the system. Not only the lectures, but also the exercises are provided in granular form, so that everyone can get a large set of knowledge in small portions to observe the rules of Microlearning. In addition to providing storage for files and resources, the system serves as a cloud technology through which files can easily be shared with relevant users. It is integrated a curriculum that is visible to all types of users. Every user can add a personal event in the Planner menu which is customized, allowing access to the event to remain individual or to be shared with a specific user group. One of the most important feature is the distance classroom. In the e-classroom, the teacher can manage his current (but also past and future) disciplines for the respective semester, can access student projects and assignments, or evaluate a course. For convenience, a multi-stage filter has been suggested to achieve the most accurate results. If access to a particular student or group of students is required, there is a section provided again with filtration by year of study, specialty and form. The teacher, just like the other users, has the opportunity to follow the current news provided by the administrator. Teacher is able to write instant messages to other colleagues, students, and business professionals by a direct communication module. Teachers sign in the system with an email and password. After a successful login, three main sections are displayed on the screen – the current lectures, exercises and the specialized calendar.

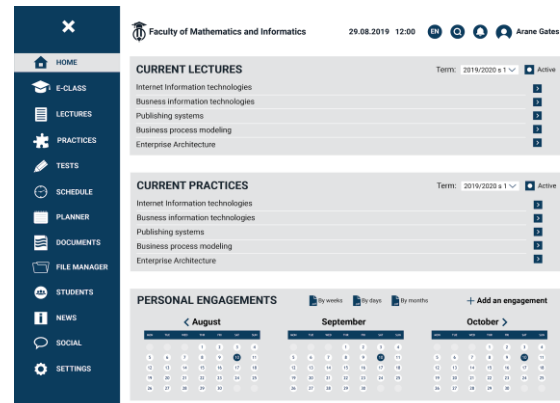

Figure 1. Teacher's home screen

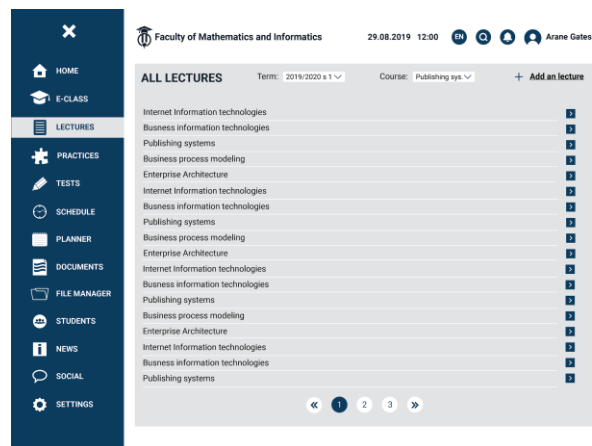

Figure 2. Management of lectures in teacher's module

The teacher can access his or her lectures and exercises from the buttons on the right of each row, then edit and update them (see Fig. 1). In the last section, there is an opportunity to filter the results by day, week and month for successful organization of activities. Teachers have the right to create their own lectures or practices and assign tests through the system. After selecting the Lectures section, it becomes available the full list of lectures that can be filtered (see Fig. 2) Each entry can be edited by the specific button on the right. Additionally, the user can also add a new lecture.

When Add Lecture button is selected, the window for entering data for the corresponding lecture is displayed (see Fig. 3). It is necessary to fill in the name of the lecture as well as information about the course to be taught. The information consists of data of a specialty, course, year and form of learning. After completing all the fields, it is necessary to describe the discipline itself in the integrated WYSIWYG text editor. Users have the ability to change the font, alignment and appearance of the text, as well as to add an image. If the lecture itself will include graphic materials, external links and additional resources, they must be attached to the corresponding lecture by the button. After successfully adding a lecture, it will become visible to the e-classroom of the respective course students.

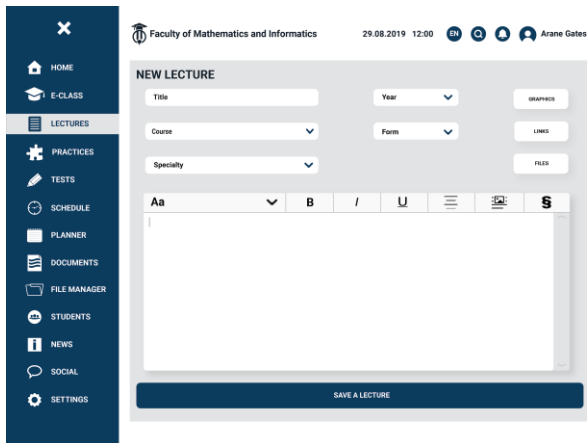

Figure 3. Adding lectures in teacher's profile

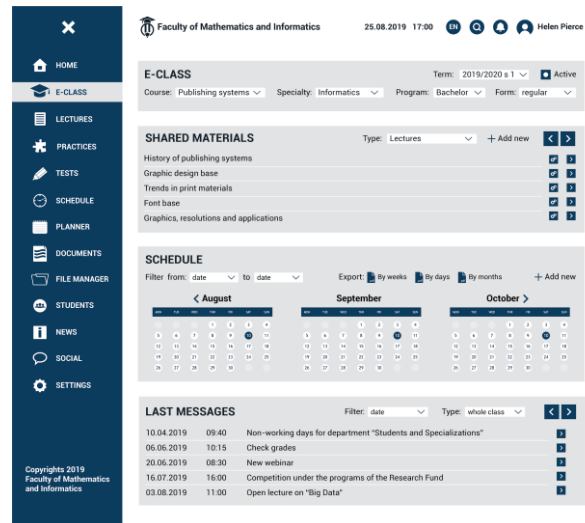

Figure 5. E-class view from teacher's profile

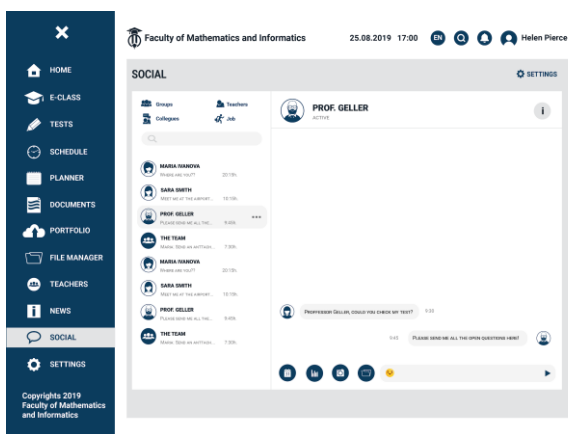

Figure 4. Social section in student's profile

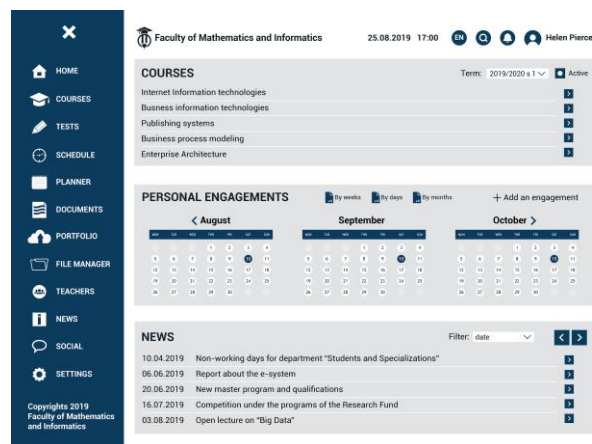

Figure 6. Student's home screen

Fig. 4 presents a chat between student and professor. Each user has a visible list of participants with whom he or she has a conversation. When selecting a row, a new group can be created to communicate with the appropriate user. Also, one can delete the conversation or forward a message. Four more buttons for sending events, a schedule, a picture and an attachment are included in the message entry box. In addition, users can send emoticons. In group chats, each participant has a different color when presenting. The list of active chat members can be filtered from the buttons at the top.

When accessing the e-classroom, the teacher has the opportunity to filter the information that will be displayed for certain reasons (see Fig. 5). It is important to choose the specialty students, the study program, the form of learning and the exact course. In the next section again, the teacher has the right to choose what kind of material to present – a lecture or exercise. The materials can be accessed for review, editing and deleting. We will emphasize on the fact that each course is specific to the specialty in order to provide a particular learning content.

Students exist in the system after they enroll in the university. Once they have received their Faculty ID, they can successfully sign in to the system. Their home screen represents three main sections – quick access to current courses, their own calendar and news section (see Fig. 6).

After going through the exercise section and selecting a topic/lecture, the student sees an interactive exercise screen (depending on the course). At the top of the screen is a progress bar that contains all the topics of a lecture. For example, the student selects a topic, fulfills the stated task by entering his program code into the editor on the left. If he wants to copy it or find a specific line, he can select the buttons above the code. On the right is a visual screen that represents the compiled code. Upon successful execution of the task, the student may save or share his/her exercise. If there are errors, a counter is displayed on the right side of the section and the system does not allow the student to move on to the next topic.

One of the main advantages of the system is that it connects not only the students with teachers and the academic administration department, but also with their future employers. Thus, while still studying, the chance for career realization is higher and it encourages them to self-development and improvement.

Each business representative who want to be registered in the system should fill out a request form (see Fig. 8). This form will be reviewed from the dean which is responsible for the relationships with the companies. After this the user will receive a notification about rejection or



approval to the email that was specified in the request form.

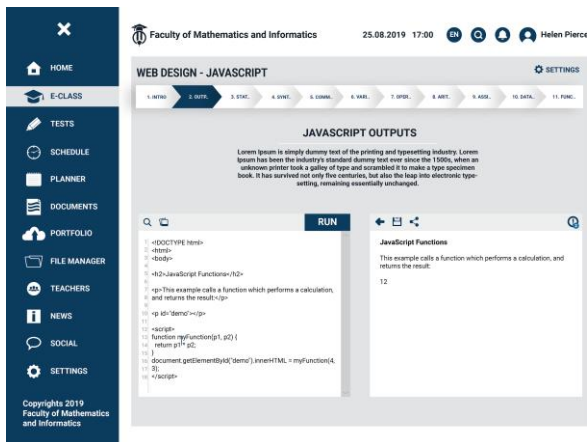

Figure 7. View of student' practices

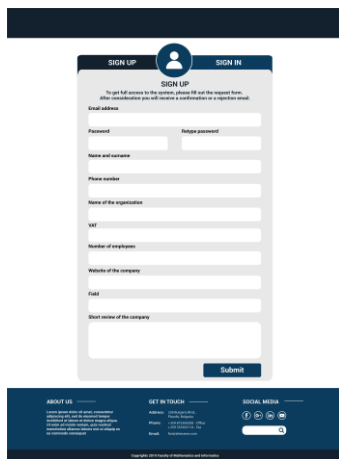

Figure 8. Request form for companies

In terms of functionality, business representatives are able to search students by applying filters such as program, specialty, academic year or form of study. They can also view a summary of student profiles, such as names, interests, skills or detailed information (see Fig. 9 and Fig. 10). If they wish to access more detailed information about a particular student, they can send a request. After confirmation they will be able to view the projects in the student portfolio or send messages in the system. The companies can communicate with teachers in order to receive opinions and recommendations. In their module are included options for creating workshops and listing open positions for interns or employee (full or part time).



Figure 9. View of student's portfolio web page

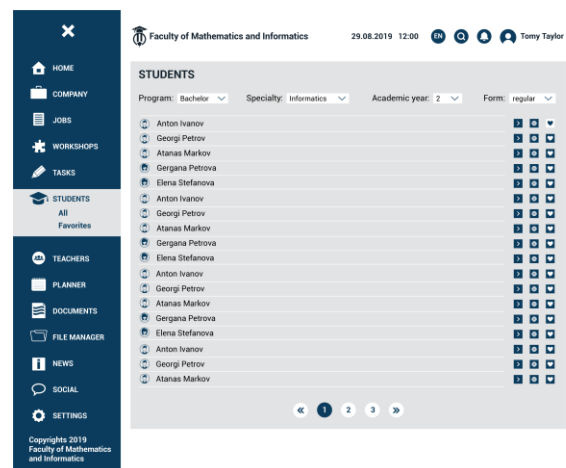

Figure 10. View from company's profile

#### IV. CONCLUSION

Despite the existing number of e-learning systems, the development of new one remain of great importance. The innovations in ICT should be taken into account and the new platforms should include accurate features and functionalities. The suggested prototype of e-learning system can be modified and not only students but also working people can take advantage of its benefits. Additionally, the system can build on the level of knowledge that is offered in the universities and can

involve teachers, students and companies in a large and united community.

ACKNOWLEDGMENT

S. Cheresharov is partially supported by Fund MU19FMI009, Plovdiv University "P. Hilendarski".

REFERENCES

- [1] M. Khribi, M. Jemni, and O. Nasraoui, "Automatic Recommendations for E-Learning Personalization Based on Web Usage Mining Techniques and Information Retrieval", *Educational Technology & Society*, 12 (4), 2009, 30–42.
- [2] A. Tarabasz, M. Selaković, and Ch. Abraham, "The Classroom of the Future: Disrupting the Concept of Contemporary Business Education", *Entrepreneurial Business and Economics Review*, 6 (4), 2018, 231–245.
- [3] K. Moharm, "A Framework for Adaptive Personalized E-learning Recommender Systems", *International Journal of Intelligent Information Systems*. Vol. 8, No. 1, 2019, 12–17.
- [4] N. Oye and M. Salleh, "E-Learning Methodologies and Tools", *International Journal of Advanced Computer Science and Applications*, 3, 2012, doi: 10.14569/IJACSA.2012.030208.
- [5] E. Ngaia, Li Xiub and C. Chaua, "Application of data mining techniques in customer relationship management: A literature review and classification", *Expert Systems with Applications*, 36, 2009, 2592–2602.
- [6] V. Vuori, "Business Intelligence Activities in Construction Companies in Finland – A Series of Case Studies", *European Conference on Knowledge Management*, At Barcelona, Spain, 2007, 1086 –1090.

# Blockchain for Business: Technology and Applications

Dušan B. Gajić and Dinu Dragan

University of Novi Sad, Faculty of Technical Sciences  
Trg Dositeja Obradovića 6, 21000 Novi Sad, Serbia  
{dusan.gajic, dinud}@uns.ac.rs

**Abstract** – This paper discusses possibilities of application of blockchain technology for both improving existing business processes and creating novel models of doing business which can lead the human society towards the programmable economy. With this motivation, a wide range of existing and potential use cases are considered. Emphasis is put on technology and applications of private permissioned blockchains, since their design philosophy and architecture represent a more natural fit for enterprise solutions. Challenges for successful business applications of the blockchain technology, as well its potential impacts, are also examined.

## I. INTRODUCTION

In the last thirty years, the Internet has created a new globally interconnected and open digital environment. Blockchain, which is a special case of distributed ledger technology (DLT), appeared a decade ago as a novel digital solution which proved to be a promising tool to effectively harness the possibilities offered by the global Internet domain [1]. In fact, blockchain engineered correctly has the potential to do the same for the exchange of value what the Internet did for the exchange of information.

In the last three years, cryptocurrencies, such as Bitcoin [1] and Ethereum [14], have been a subject of tremendous public interest, mostly due to their sharp increases and decreases in value. Cryptocurrencies are based on public blockchains and support digital value exchange without a central authority. This decentralizes trust, eliminates the need for intermediaries, and prevents the double-spending problem in the digital domain [1]. However, this interest of general public also created a common misconception that cryptocurrencies and blockchain are one and the same. In fact, cryptocurrencies are only the first use case of the blockchain's distributed ledger, which is more fundamental and has its roots in theoretical computer science. Furthermore, the application of distributed ledgers, especially in the form of private permissioned blockchains, has much more to offer in business domains other than cryptocurrencies, e.g., finance, supply chains, trade, healthcare, and government [15]. This is since blockchain provides algorithmically built-in trust and smart contracts, which allow transparent, traceable, and trustworthy exchange of value [1, 11].

World's leading advisory company Gartner predicts that blockchain will be the key technology allowing the

creation of the programmable economy [2]. The programmable economy is predicted to appear around year 2030[2]. It is expected to represent a massive technology-enabled transformation of traditional concepts of value exchange, empowering both individuals and smart machines to define value and determine how it is exchanged. This would allow for true automation in the field of exchange of value and the introduction of artificial intelligence agents into the financial sphere as first-class participants. The consequence of this revolution would be the first fundamental change in the organization of finance since the introduction of double-entry bookkeeping five hundred years ago.

The remainder of the paper is organized as follows. Section 2 discusses the blockchain technology in general and private permissioned blockchains in particular, which offer several advantages over public blockchains for enterprise use. In Section 3, we investigate different current and future use cases of the blockchain technology in business. Technology challenges standing in the way of widespread blockchain adoption, as well as potential impacts of the successful use of this technology, are analyzed in Section 4. The closing section of the paper offers the main conclusions.

## II. THE BLOCKCHAIN TECHNOLOGY

As stated earlier, there is a common misconception that cryptocurrencies and blockchain are one and the same. Therefore, before we proceed to discussing blockchain technologies for business applications, we will shortly address the terminology.

A distributed ledger or distributed ledger technology is a special kind of distributed database which assumes existence of malicious users (nodes in the network). DLT can also be defined as a consensus of replicated, shared, and synchronized digital data geographically spread across multiple locations.

A blockchain is a data structure which implements a distributed ledger in a specific way. It is composed of a chain of cryptographically linked blocks containing sets of transactions. In the general case, a broadcast of all the data to all the participants in the blockchain's peer-to-peer (P2P) network is performed.

Two key components of a blockchain, in addition to the distributed ledger and P2P distributed network, are its consensus mechanism and smart contracts. A consensus algorithm ensures that data recorded on the ledger are the

same for all nodes in the network and, in doing so, prevents malicious actors from manipulating data. Smart contract is a self-executing computer program which automatically performs certain predefined actions when certain conditions within the system are met (e.g., payment is performed when certain event triggers the smart contract).

The relationship between the discussed concepts is graphically shown in Figure 1. First, DLTs represent a subset of distributed databases. Blockchain is one of the possible ways to implement distributed ledgers. Examples of DLTs which are not blockchains include systems like IOTA [22] and Hedera Hashgraph [23]. In regard to access permissions to the data stored on the blockchain, systems are divided into public and private (when read operation is considered) and permissionless and permissioned (when write access is in question).

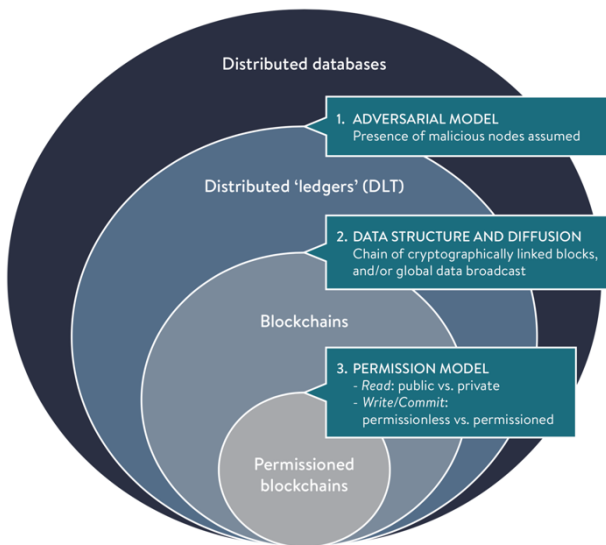

Figure 1. Relationship between distributed databases, distributed ledgers, blockchains, and permissioned blockchains (Image source: [11]).

Public permissionless blockchain technologies, such as Bitcoin [1] and Ethereum [14], are used as basis for cryptocurrencies, which were the first application of blockchain in practice. Private permissioned blockchain technologies, on the other hand, are better suited for typical business applications, due to their properties such as granular data access control, high transaction throughput, scalability, privacy, and modularity. For these reasons, private permissioned blockchains are most often used in business applications, even though they require more complex setup and higher costs of running business networks than public blockchains [9]. Representatives of enterprise blockchains include systems like Hyperledger Fabric [6] and R3 Corda Enterprise [18]. There are also hybrid blockchains, such as Cosmos based on Tendermint Core [17], which in terms of their properties stand at the intersection of different approaches to blockchain implementation.

Table I presents main properties of three distinctive blockchains. Each one is a representative of one of the three different generations which appeared throughout the

TABLE I. MAIN PROPERTIES OF THE BITCOIN, ETHEREUM, AND HYPERLEDGER FABRIC BLOCKCHAIN TECHNOLOGIES.

Property	Technology		
	Bitcoin	Ethereum	Hyperledger Fabric
Crypto-currency	bitcoin (BTC)	ether (ETH)	none
Read access	public	public	private
Write access	permissionless	permissionless	permissioned
Transaction	anonymous	anonymous	public or confidential
Consensus	Proof of Work	Proof of Work	modulare (SOLO, Kafka, Raft)
Smart contracts	No	Yes (LLL, Serpent, Solidity)	Yes (Go, Node.JS)

evolution of blockchain technology from 2008 to its present state.

Bitcoin and Ethereum are the most popular public permissionless blockchains used for operating cryptocurrencies. Bitcoin appeared first and introduced the proof of work consensus algorithm but didn't offer support for smart contracts [1]. Ethereum, as a second generation blockchain technology, introduced the support for smart contracts. These smart contracts are executed on the Ethereum virtual machine and are written in domain-specific Turing-complete languages such as LLL, Serpent, or Solidity [14]. Hyperledger Fabric is a third generation blockchain working in a private permissioned setting without a native cryptocurrency. It allows development of smart contracts in general-purpose programming languages such as Go and Node.JS. These Fabric smart contracts are called chaincode and are executed using Docker containers [6]. Further, Fabric has a special membership services provider component which performs authentication of all participants in the business network using appropriate organization (root) and user certificates. Modular consensus mechanism in Fabric, in contrast to energy-wasting Proof-of-Work algorithms used in Bitcoin and Ethereum, allows high transaction throughput and low cost of transactions which can be truly confidential. Privacy of transactions in Fabric is achieved using channels (subnetworks) which have separate distributed ledgers kept only by participants which should be aware of the concrete transaction. When the before-mentioned properties are considered in the context of typical business application requirements, benefits of using private permissioned blockchain systems such as Hyperledger Fabric in the enterprise setting are clear.

### III. BLOCKCHAIN APPLICATIONS IN BUSINESS

The first application in which blockchain technology proved its potential value were cryptocurrencies. This use case offered only a glimpse of what application of blockchain technology can bring to other domains of

human affairs. If fully adopted, blockchain can change the way business is conducted across industries on both local and global levels [2].

However, there will probably never be a single global blockchain that all business use. Instead, many public and even more private distributed ledgers designed for specific use cases will be in existence and everyday use. They will need to interoperate through standardization and, in the ideal case, share a common base technology [15]. This potential shared base technology would certainly need to allow use of different smart contract languages, consensus algorithms, etc.

A distribution of various blockchain use cases per industry segments, which is a part of the study presented in [11], is shown in Figure 2. In this paper, we will consider some of the most popular blockchain business use cases, such as the ones in banking and finance, supply chain, healthcare, and government.

#### *A. Banking and Finance*

One of the main factors limiting the speed growth of world economy today are the costs and time required for performing transactions, especially in the cross-border context. Blockchain systems, such as Ripple [12], Stellar [13], and Hyperledger Fabric [15], offer a new, cheaper and faster way of performing international transactions. As shown in [12, 13], remittances and micropayments can be performed faster and at significantly lower costs using the distributed ledger technology. New services for the unbanked, such as loans and micro-savings, can be offered due to cost reductions made possible by the blockchain technology. Even traditional global payment processors, such as Visa [16] and MasterCard [21], have already launched business-to-business (B2B) networks for cross-border payments using the Hyperledger Fabric [6] and the R3 Corda Enterprise blockchain technologies [18], respectively.

Stock exchanges can also greatly benefit from the ability to track and trade stocks and other financial instruments using the blockchain's distributed ledger with lower risk, shorter times, and increased transparency [15]. New kind of markets, such as private equity capital markets, can be developed if the blockchain is applied in synergy with machine learning and data science techniques. Liquid private equity capital markets can lead to fostered innovation in the world due to better access to capital for startups and small and medium enterprises, since this kind of investments then becomes more attractive, less risky, and accessible to a broader audience of potential investors.

Blockchain-based worldwide trading systems, such as we.trade, are also in development [15]. This kind of platforms allow secure and near-real time exchange of data considering transactional financing providing for built-in compliance with any kind of regulations.

#### *B. Supply Chain*

Introduction of blockchain technology can also lead to improved efficiency of supply chains. Further, as shown

in [15, 19], application of blockchains results in safer and more ethical conduct of all stakeholders due to the transparency of all the transactions that happen within the supply chain system.

In January 2018, Maersk and IBM presented the TradeLens blockchain shipping solution [19]. This solution, based on the Hyperledger Fabric enterprise blockchain technology [6], allows different trading partners to collaborate by establishing a single shared view of transactions without compromising details, privacy, or confidentiality [19]. TradeLens allows more efficient interaction between shippers, shipping lines, freight forwarders, port and terminal operators, inland transportation, and customs authorities by allowing real-time access to shipping data and shipping documents. Data and documents in the system are acquired using Internet-of-Things (IoT) and a broad set of sensors ranging from ones controlling the temperature to ones reporting the weight of containers [19].

A use case described in [15], shows how the Hyperledger Sawtooth blockchain technology can be used to trace the journey of seafood from seas and oceans to the table and, in doing so, ensure more ethical practices and prevent illegal fishing. Application of blockchain technology in diamond supply chain, which prevents "blood" diamonds from entering market is also described in [15]. A research reported in [8] shows how the Hyperledger Fabric blockchain can be used for tracking medicine in the pharmaceutical industry and supply chain.

#### *C. Healthcare*

Application of private permissioned blockchain technology offers a possibility for the healthcare systems to create a novel common platform for sharing information between different organizations. Anyone who ever interacted with any existing healthcare system can easily see that this is a need which often appears in practice. Such a platform would allow storage and sharing of sensitive personal electronic health records (EHRs) on a secure, and permissioned distributed ledger [15]. Projects such as MedRec from MIT [28] and phrOS [29] confirm that application of blockchain can offer improved access and exchange of medical records with reduced costs.

Providing healthcare and social services to population of underdeveloped countries, as well as to homeless population in developed countries, can greatly benefit from a decentralized system based on the blockchain technology that connects together the identity of individuals who often don't have documentation, changing living locations, or have a need to receive healthcare services in different places [15]. Blockchain can also help in disaster relief actions by allowing data to be added and shared through a DLT providing live feed to multiple agencies' relief efforts [30].

Another blockchain application presented in [15] is medical licensing which improves the efficiency and accuracy of international medical credentials processing and verification.

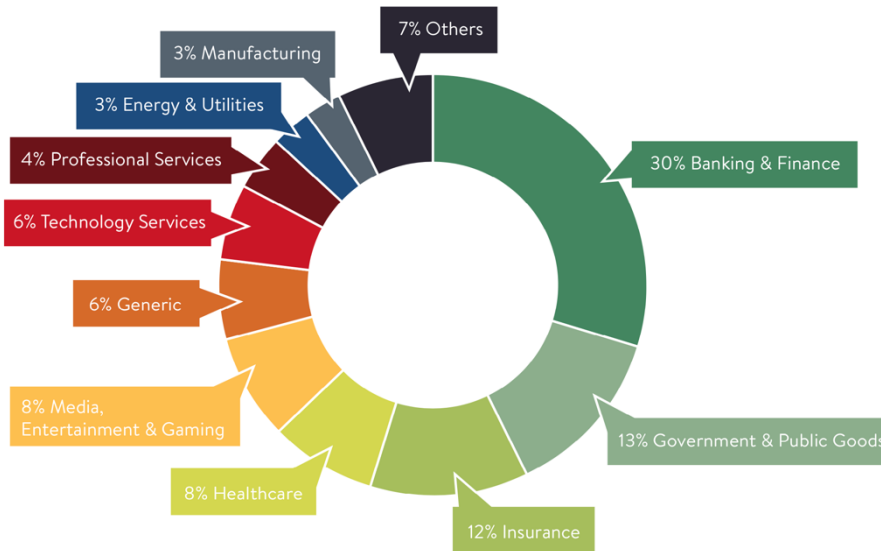

Figure 2. Blockchain use cases in different industry segments (Image source: [11]).

#### D. Government

As shown in Fig. 3, applications of blockchain in the government domain are expected to reach full productivity right after the ones in banking and investment services, thus building trust with citizens, protecting sensitive data, and reducing costs [31].

However, several important questions need to be solved to achieve this. First, when citizens want to interact with government agencies, they need to prove their identity. Great inefficiencies, which exist in traditional mechanisms of checking the identity, are even further emphasized in the digital domain if not dealt with properly.

A tamper-evident record stored on the blockchain can provide a solid foundation for dealing with digital identity. As described in [15], digital identity processes such as know your customer (KYC) and anti-money laundering (AML) can greatly benefit from using DLTs and blockchains. Blockchain can also serve as foundation for solutions which can provide a verifiable digital identity for refugees or in natural disasters [15, 30]. Revolution in regulatory compliance of other business process, in addition to the KYC and the AML, such as automatic auditing, taxation, and financial crime prevention, can also be achieved by applying blockchain [20]. As described in [10], use of private permissioned blockchains can lead to paperless international trade performed between jurisdictions of different governments. This can make international trade faster, cheaper, and more secure and contribute to a faster global economy growth.

Future development of the blockchain technology and supporting legal framework is predicted to allow smart contracts to almost completely replace traditional contracts. Such a change to our law systems would greatly influence governments worldwide since one of their main existing functions is ensuring rule of law. Smart contracts offer a promise of transferring this insurance from centralized authorities to distributed algorithms and data structures, thus serving as one of the key components

included in the predicted appearance of the programmable economy [2].

#### IV. CHALLENGES AND IMPACT

There are a number of challenges that need to be overcome in order for the blockchain technology to achieve its full potential in different applications.

Figure 3 shows the hype cycle for blockchain business applications devised by Gartner [2]. As it can be seen, even the application of blockchains for cryptocurrencies, complementary currencies, and digital commodity exchanges is still several years away from reaching the plateau of productivity. Achieving the fully productive application of DLTs in fields such as supply chains and healthcare is expected at about the same time when the programmable economy is expected to appear – not before year 2030. There are a number of challenges, both in technology and organization of society, that we need to tackle before.

##### A. Challenges

It is important to stress out that blockchain in general is by no means an immature technology. First of all, more than a decade which has passed since the original Bitcoin paper in 2008 is already a significant timespan [1]. Further, blockchain is a combination of technologies that are almost 40 years old, as well as a specific solution of mathematical problems known for decades. For example, blockchain can be seen as a solution in a specific context for the Byzantine generals' problem presented in 1982 by Lamport, Shostak, and Pease [3]. The first efficient solution to this problem dates back to 1999 and the work of Castro and Liskov [4].

However, the problem of consensus mechanism performance still needs to be efficiently solved to allow creation of blockchain networks which can, at the same time, support high transaction throughput and large number of nodes [7]. In order to replace existing global payment solutions, blockchains will need to support both

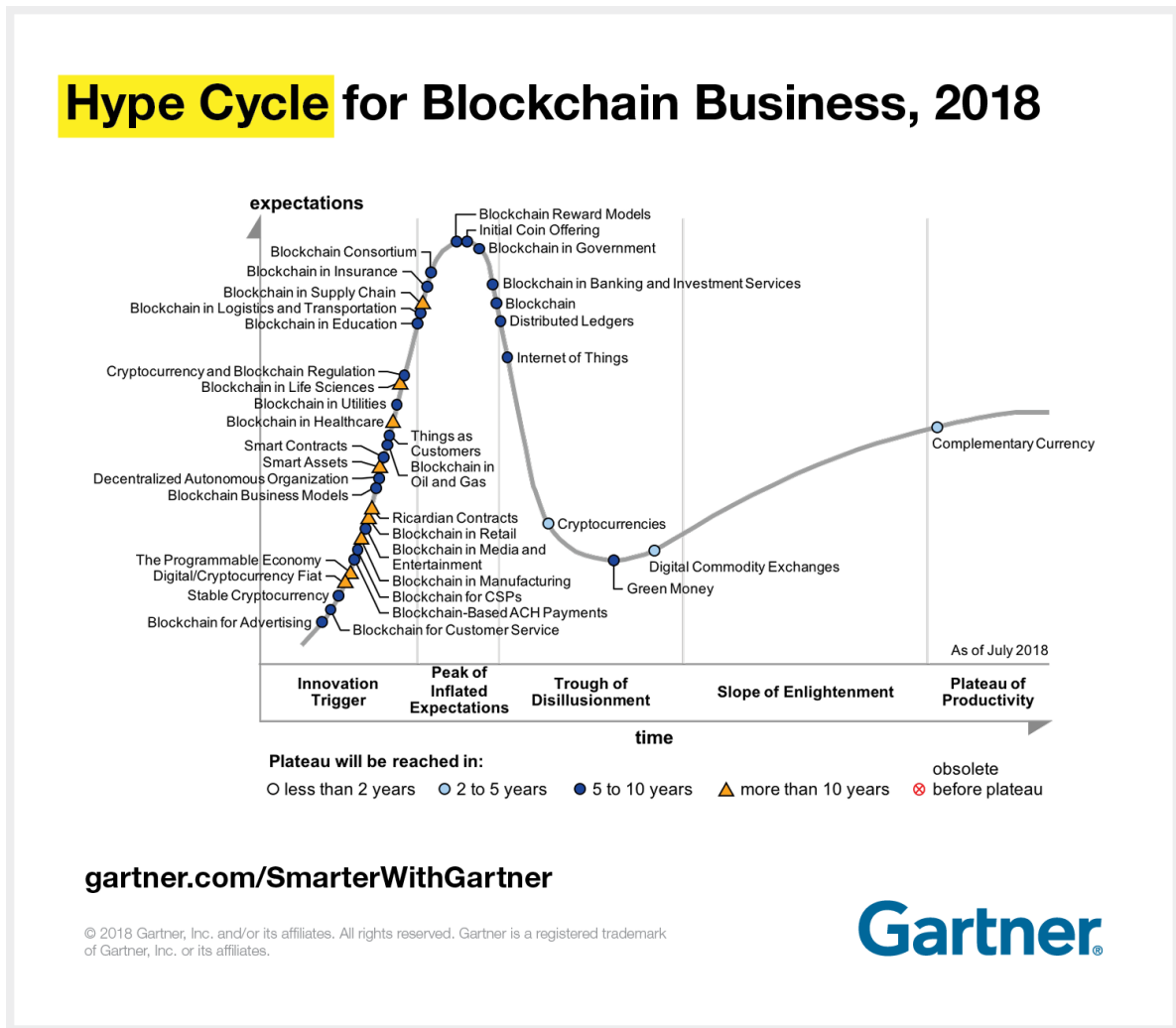

Figure 3. Gartner hype cycle for blockchain business applications (Image source: [2]).

thousands of transactions per second and large networks with tens and hundreds of thousands of participants.

Interoperability between different blockchains and disparate networks is also an open issue which projects such as Quant Overledger [24] try to address.

The problem of privacy and confidentiality, especially in the public blockchain context, also needs to be solved to achieve the full potential of blockchain technology. Data protection laws, such as the GDPR (General Data Protection Regulation) adopted by the European Union [11, 25], include articles such as “right to be forgotten” which stand in sharp contrast to the nature of how data are stored on the blockchain. However, private permissioned blockchains can better handle these questions. Part of the solution for achieving some privacy on the public blockchains can be the use of the zero-knowledge proof approach [26] and systems like Zcash [27].

Another challenge for blockchain technology in the cryptographical sense is quantum computing. Nevertheless, even this threat has several countermeasures. First of all, permissioned blockchains are less vulnerable for such kind of attacks. Second, there

are already examples of quantum-resistant encryption algorithms, like the Blockchain Post-Quantum Signatures (BPQS) algorithm [5].

Blockchain also changes quite a lot in the technology paradigm. Because of incredibly high and constantly growing demand for blockchain developers, more and more engineers are looking at it and learning. That, in return, creates an unprecedented level of new knowledge supporting further growth in the area. Basically, this closed loop is what makes blockchain evolve so fast from the technology perspective. Appearance of cryptocurrencies led to enormous funds being invested into the research and development of the technology itself. This R&D resources will hopefully help solve the remaining technology challenges in the future. However, this will not be enough. For fully using the blockchain features in real-world applications, it will be even more important that changes in the legal and financial frameworks worldwide follow.

### B. Impact

Blockchain allows to establish a foundation for a new society, where trust in business relations will become less

of an issue, since, in programmable economy, it will be guaranteed by code. Widespread application of blockchain in business relations would take some time, but it will naturally improve our cooperation. It will allow us to find new ways to seamlessly establish relations disregard of distance and origin. By making these changes possible, blockchain becomes probably the most powerful driver for eliminating not just financial issues, but any kind of discrimination due to zero-knowledge proofs.

## V. CONCLUSION

In this paper, we first investigated the basics of blockchain technology. Advantages of private permissioned blockchains for enterprise applications have been discussed. Further, we explored possibilities of application of blockchain technology for both improving existing business processes and creating novel ones. These new ways of doing business are expected to lead the human society towards the programmable economy in the coming decade. We discussed main challenges for blockchain technology to reach its full potential, such as performance issues, interoperability between different blockchains, privacy, confidentiality, and the quantum computing threat. Overcoming these challenges would allow blockchain to become the “Internet of value” and serve as the key for unlocking the potential of the programmable economy.

## ACKNOWLEDGMENT

The reported research is partly supported by the Ministry of Education, Science, and Technological Development of the Republic of Serbia, projects III44006 (2011-2019), ON174026 (2011-2019), and TR32044 (2011-2019).

## REFERENCES

- [1] S. Nakamoto, “Bitcoin: A Peer-to-Peer Electronic Cash System”, [Online], available at: <https://bitcoin.org/bitcoin.pdf>, 2008, last access 28 August 2019.
- [2] H. P. Levy, “The Reality of Blockchain”, [Online], Gartner, available at: <https://www.gartner.com/smarterwithgartner/the-reality-of-blockchain/>, last access 28 August 2019.
- [3] L. Lamport, R. Shostak, and M. Pease, “The Byzantine Generals Problem”, *ACM Transactions on Programming Languages and Systems*, vol. 4, no. 3, pp. 387-389, 1982, doi: 10.1145/357172.357176, [online], available at: <https://people.eecs.berkeley.edu/~luca/cs174/byzantine.pdf>, last access 28 August 2019.
- [4] M. Castro and B. Liskov, “Practical Byzantine Fault Tolerance”, in *Proc. 3<sup>rd</sup> Symposium on Operating System Design and Implementation*, pp. 173-186, New Orleans, USA, February, 1999, available at: <http://pmg.csail.mit.edu/papers/osdi99.pdf>, last access 28 August 2019.
- [5] K. Chalkias, J. Brown, M. Hearn, T. Lillehagen, I. Nitto, T. Schroeter, “Blockchain Post-Quantum Signature”, [Online], R3 Corda, available at: <https://eprint.iacr.org/2018/658.pdf>, last access 28 August 2019.
- [6] The Linux Foundation, Hyperledger Fabric, [Online], available at: <https://www.hyperledger.org/projects/fabric>, last access 3 September 2019.
- [7] E. Androulaki, A. Barger, V. Bortnikov, C. Cachin, K. Christidis, A. De Caro, D. Enyeart, C. Ferris, G. Laventman, Y. Manevich, S. Muralidharan, C. Murthy, B. Nguyen, M. Sethi, G. Singh, K. Smith, A. Sorniotti, C. Stathakopoulou, M. Vukolić, S. Weed Cocco, and J. Yellick, “Hyperledger Fabric: ADistributed Operating System for Permissioned Blockchains”, in: *Proceedings of the Thirteenth EuroSys Conference (EuroSys '18)*, ACM, New York, NY, USA, Article30, doi: <https://doi.org/10.1145/3190508.3190538>, available at: <https://arxiv.org/pdf/1801.10228.pdf>, last access 3 September 2019.
- [8] A. Mirković, M. Nenić, D. Gajić, B. Terzić, I. Luković, “An Application of Blockchain Distributed Systems for Supply Chains in the Pharmaceutical Industry”, in: *Konjović, Z., Zdravković, M., Trajanović, M. (Eds.) ICIST 2018 Proceedings, vol.1*, pp.100-104, 2018.
- [9] A. Mirković, B. Terzić, D. Gajić, I. Luković, M. Nenić, “A Model-Driven Approach to Establishment of Private Blockchain Business Networks”, in: *Konjović, Z., Zdravković, M., Trajanović, M. (Eds.) ICIST 2019 Proceedings, vol.1*, pp.10-14, 2019.
- [10] V. Ivković, N. Todorović, D. Gajić, N. Todorović, “Boosting Transition to Paperless Trade – Mapping Traditional Trade Contracts to Smart Contracts”, in: *Konjović, Z., Zdravković, M., Trajanović, M. (Eds.) ICIST 2019 Proceedings, vol.1*, pp.150-154, 2019.
- [11] G. Hileman, M. Rauchs, “Global Blockchain Benchmarking Study”, [Online], available at: [https://www.ey.com/Publication/vwLUAssets/ey-global-blockchain-benchmarking-study-2017/\\$FILE/ey-global-blockchain-benchmarking-study-2017.pdf](https://www.ey.com/Publication/vwLUAssets/ey-global-blockchain-benchmarking-study-2017/$FILE/ey-global-blockchain-benchmarking-study-2017.pdf), Cambridge Centre for Alternative Finance, University of Cambridge, UK, 2017, last access 5 September 2019.
- [12] Ripple, [Online], available at: <https://www.ripple.com>, last access 5 September 2019.
- [13] Stellar, [Online], available at: <https://www.stellar.org>, last access 5 September 2019.
- [14] V. Buterin, Ethereum Whitepaper, “A Next-Generation Smart Contract and Decentralized Application Platform”, available at: <https://github.com/ethereum/wiki/wiki/White-Paper>, last access 5 September 2019.
- [15] The Linux Foundation, Hyperledger, “The Hyperledger Vision”, [Online], available at: <https://www.hyperledger.org/wp-content/uploads/2018/03/The-Hyperledger-Vision-11-1.pdf>, last access 5 September 2019.
- [16] Visa, “Visa B2B Connect Launces Globally”, [Online], published on 11 June 2019, available at: <https://usa.visa.com/about-visa/newsroom/press-releases.releaseId.16401.html>, last access 5 September 2019.
- [17] Tendermint, “Tendermint Core”, [Online], available at: <https://tendermint.com>, last access 5 September 2019.
- [18] R3 Corda, “Corda Enterprise – a next-gen blockchain platform”, [Online], available at: <https://www.r3.com/platform/>, last access 5 September 2019.
- [19] IBM, “Maersk and IBM Introduce TradeLens Blockchain Shipping Solution”, [Online], available at: <https://newsroom.ibm.com/2018-08-09-Maersk-and-IBM-Introduce-TradeLens-Blockchain-Shipping-Solution>, last access 11 September 2019.
- [20] C. Moyce, “How Blockchain can Revolutionize Regulatory Compliance”, [Online], available at: <https://www.corporatecomplianceinsights.com/blockchain-regulatory-compliance/>, last access 12 September 2019.
- [21] MasterCard, “MasterCard and R3 Partner to Develop New Blockchain-Powered Cross-Border Payments Solution”, [Online], available at: <https://newsroom.mastercard.com/press-releases/mastercard-and-r3-partner-to-develop-new-blockchain-powered-cross-border-payments-solution/>, last access 13 September 2019.
- [22] IOTA, [Online], available at: <https://www.iota.org/>, last access 14 September 2019.
- [23] Hedera Hashgraph, [Online], available at: <https://www.hedera.com/>, last access 14 September 2019.
- [24] Quant Overledger, [Online], available at: <https://www.overledger.com>, last access 14 September 2019.



**International conference on Applied Internet and Information Technologies  
October 3-4, 2019, Zrenjanin, Republic of Serbia**

---

- [25] The EU General Data Protection Regulation, [Online], available at: <https://eugdpr.org>, last access 14 September 2019.
- [26] S. Goldwasser, S. Micali, C. Rackoff, "The knowledge complexity of interactive proof systems", *SIAM Journal on Computing*, Philadelphia: Society for Industrial and Applied Mathematics, vol. 18, no. 1, pp. 186-208, 1989.
- [27] Zcash, [Online], available at: <https://z.cash>, last access 14 September 2019.
- [28] MIT, MedRec, [Online], available at: <https://medrec.media.mit.edu>, last access 12 October 2019.
- [29] Taipei Medical University, phrOS, [Online], available at: <https://phros.io/#home>, last access 12 October 2019.
- [30] J. Dwyer III, "Troop Support event poses question: How and where can blockchain help?", US Defense Logistics Agency, [Online], available at: <https://www.dla.mil/AboutDLA/News/NewsArticleView/Article/1720207/troop-support-event-poses-question-how-and-where-can-blockchain-help/>, last access 12 October 2019.
- [31] K. Boeding, "3 Potential Benefits of Blockchain for Government", [Online], available at: <https://www.boozallen.com/s/insight/blog/3-potential-benefits-of-government-blockchain.html>, last access 12 October 2019.

# SMART City - GIS and IoT integration

Srdan Popov

University of Novi Sad, Faculty of Technical Sciences, Novi Sad, Serbia  
srdjanpopov@uns.ac.rs

**Abstract - The Smart City is a common used phrase. It could be considered as context model for data collecting and model of data usage in urban and suburban areas. The aspects of observing this phenomenon are diverse, as are the contexts in which it can be placed. To enable the existence and cohabitation of administrative procedures, hazardous situations or entertainment activities, situations resulting from urban climate or settler activity, an integration platform for data acquisition and usage is required. It is important to create a data structure or, better, an infrastructure equivalent to this phenomenon. Actually this kind of observation data, in the context of the phenomenon of IoT and GIS brings a new interpretation of data GoT Geography of Things. It support multidimensional spatial and spatial based data. Data sources are heterogeneous and anachronistic, based on individual measurement or collected as a series in real-time or off-line.**

## I. INTRODUCTION

When talking about IoT and GIS, we're talking consequently about interconnectivity among devices and bringing data into a spatial context. In this way, the application of IoT concept combined with GIS relates to the use of several devices connected to a server in order to obtain a lot of data to be used to feed the information system or to use data in real-time and spatial context.

This may involve a lot of devices beyond smartphones: personal computers (mainly laptops), smartwatches or so, dedicated to work with geoprocessing, detection of weather conditions, etc. A new term also emerged from the combination of IoT with geoprocessing: Geography of Things (GoT). The Global Standards Initiative on the Internet of Things (IoT-GSI) has defined IoT as "an information society infrastructure." IoT allows objects to be spotted or controlled remotely through existing network infrastructure, allowing for the immediate integration of the physical world into computer-based systems, resulting in increased efficiency, accuracy and economic benefit, with reduced human intervention. When IoT is amplified by sensors and actuators, technology becomes an instance of a general class of cyber-physical systems, which also includes technologies such as smart grids, virtual power plants, smart homes, intelligent transportation, and smart cities. Each thing is uniquely recognizable through a nested computer system, but is also capable of interoperability within the existing Internet infrastructure.

The sharing of methods and data has been recognized by Kamilaris A. and Ostermann F. O. [1]. They bring the terms "Internet of Things", "Pervasive Computing",

"Geospatial Analysis", and "Geographical Information Systems (GIS)" in common context, because the research domains of geographic information science and IoT are still relatively separated with publication patterns focusing either on one direction or the other, but not on their intersection. That intersection is our sphere of interest.

## II. INTELLIGENCE AND DECISION SUPPORT SYSTEMS FOR SMART CITIES BASED ON SERVICE ARCHITECTURE

Information Infrastructure of Smart City is particularly interesting in the aspect of integrated risk management. This is the scenario we are interested in:

- An event with catastrophic consequences occurred (real-time or off-line).
- The person in charge of integrated incident management should have "everything needed to make decision".
- What needs to be provided, in terms of the functionality of a service oriented information system?
- The chosen methodology should be based on standards.
- Situations of interest to be viewed in 2D and 3D space, and be processed services characteristic of 2D, 3D and temporal data.
- Implementation to follow the relevant directives on a real space-time system.

Intelligence and decision support systems in the area of risk analysis with catastrophic consequences depend on multidimensional spatial and spatial based data. The sources of such data are heterogeneous and often anachronistic. Data formats are based on different standards: ISO, OGC, Industrial, National, Traditional, Informally agreed, or even no standards or arrangements.

Data is the product of modern, technologically advanced systems (sensor systems, GIS, various expert systems), of traditional, often outdated systems. Also the data infrastructure partly exists (2D SDI), partly does not exist (3D SDI).

It is necessary to ensure the interoperability of this data, and a way to market it in a technologically modern and highly usable way.

A particular case that has to be addressed is 3D spatial and spatially based data, their formats, appropriate data structures, interpretation and presentation, services for handling them; in other words 3D SDI [6].

The construction of spatial data infrastructure has been an important and actively followed topic in geographical research for years. A special part is the services required for 3D spatial data infrastructure, as well as the aspects that must be considered in order to build this type of infrastructure. It also concerns policy and decision-making, as well as the harmonization of technologies to reduce time and cost in the construction of spatial services for internal use, as well as for public information services. At European level, the new INSPIRE Directive 2007/2/EC intends to lay down general rules for the implementation of national spatial data infrastructure for environmental policy purposes (Figure 1). From a technical point of view, FDI should rely on standards adopted by, among others, OGCs (WMS, WFS, WCS, OpenLS ...) [2].

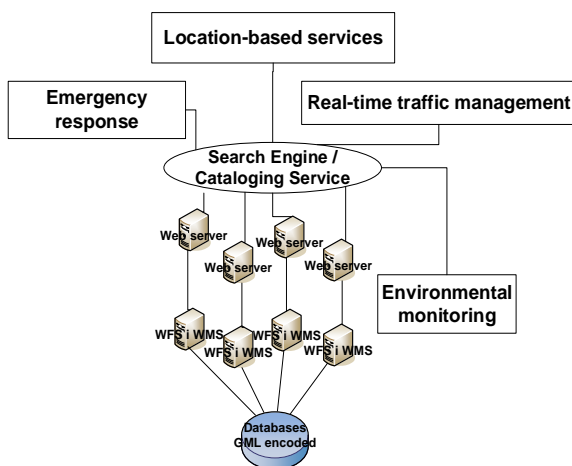

Figure 1 – Service architecture

Particularly important services are Data Interoperability Services Interoperability is the ability of two or more autonomous, heterogeneous and distributed digital components (systems, applications, procedures, or datasets) to communicate and cooperate with each other despite any differences in language, context, format or computer platform.

In the absence of interoperability, the following disadvantages are explicitly emphasized:

- Expensive conversions and data sharing
- Data redundancy
- A difficult and complex problem of updating data
- Lack of data

Interoperability is achieved through the Web service. The solution is actually the following combination:

- Service Oriented Architecture (SOA) and Web Services.

- Independent components, based on open transport protocols and XML based standards for data exchange.

- Available over TCP/IP.

- Standards provide interoperability (interface semantics, data coding ...).

Interoperability plays an important role in Web applications. They would be significantly immobilized without the ability to visualize patterns (patterns) in a critically short time. Since many systems are based on closed systems, it is difficult to achieve interoperability and solution to problems arising from syntactic, structural, and semantic heterogeneities between data sources [10]. Today, many researchers agree that adopting open standards is an important approach for realizing the interoperability of geographic information systems and sharing real-time spatial information through the Web [5].

### III. IOT INTEGRATION CONCEPT

The concept of observational data is treated as data obtained by reading a property of a real-world entity. The result of the observation is the value of this property [7]. Sensors across the city also make observations, making content annotations. Annotations allow for interoperability and detection, making data easier to understand and therefore use.

#### A. W3C Semantic Sensor Network

The W3C Semantic Sensor Network (SSN) is an ontology that aims to describe sensors, observations, and related concepts, such as sensor capabilities and measurement processes. SSN is able to annotate the data so that we can determine which sensor that data is coming from, using which measurement process to read a particular property of the entity of interest. Although they are unable to describe the sensor network behind the data collected, SSN is not based on a standard approach like the W3C PROV-O. SSN is ontology and does not care about how data is transferred from their collections in terms of formats and datasets. BOnSAI and SMDO (Sesame Meter Data Ontology) are also network sensory ontologies that focus on smart buildings [3][4][9].

#### B. Human-Aware Sensor Network Ontology

Although large enough to provide scientists with enough to monitor their activities, HASNetO (Human-Aware Sensor Network Ontology) faces challenges in dealing with data collected in a large and complex environments such as urban environments. One of these challenges is that the data collected has been used not only by the city administration or the people involved in the measurements but also by citizens. Therefore, HASNetO-SC (HASNetO-Smart City) is proposed. The main objective of HASNetO-SC is to provide an efficient way of collecting, preserving and disseminating urban data with an appropriate level of contextual metadata to understand the data itself [11].

HASNet-SC focuses on smart-city features that have the greatest potential to provide data that can be collected empirically and effectively:

- Smart people
- Smart mobility
- Smart environment
- A smart lifestyle

This extension virtually refines the VSTOI concepts that are integrated into HASNetO to better suit urban data collection.

### C. Contextualized CSV (CCSV)

Use CCSV is a CSV extension addresses content and content restrictions when handling observational data. In this approach, content and contextual metadata are required to obtain a connection between data and metadata. From a smart city perspective, it is necessary to classify the Turtle preamble of the CCSV dataset with the ontological concept of HASNetO-SC

The introduction contains the following descriptions:

- Knowledge based: To enable multi-contextual data collections and make solutions more scalable, the data set is enabled to determine what knowledge to use for validation.
- Implementation: The implementation of information enables the linking of the data transferred by the CCSV dataset to the metadata information: (1) instruments and detectors (sensors), (2) platforms, (3) all attached information, precision, location, platform, etc.
- Data collections: The use of data collection information in a CCSV introduction enables the architecture of the knowledge of a data set: it is able to know whether a particular data set is produced under the same context, or provide the user with sufficient contextual information to determine if the data is within different sets can be compared, merged or analyzed.
- Data Set: Datasets are not scientific constraints on data, but rather are data collection activities. This description links the datasets to their respective data collections.
- Measurements: Describes all measured characteristics. For each type of measurement we associate a unit description and the measured characteristics.

### IV. IOT- GIS INTEGRATION WAHASTRAT CASE STUDY

The WAHASTRAT project [8] has developed a network of 8 automated monitoring stations (designated as WH1 – WH8) to provide information about environment variables: soil moisture, speed and wind direction, air temperature, air humidity and atmospheric precipitation. The data from these monitoring stations are collected and analyzed to provide information about water shortage, drought conditions and especially for urban climate. Further in this chapter, systems for monitoring of excess inland waters (Figure 2), meteorological values and

urban heat islands developed by experts from the University of Novi Sad will be presented.



Figure 2 – WAHASTRAT acquisition station (wahastrat.vizugy.hu)

When station is awoken, the cell switches from sleep mode to active mode. Configuration is received after connecting to the server. If the configuration parameters are valid, the data transmission is valid. In the event of a network failure, the data is stored in the internal memory of the station and sent in the next session. The data being sent is defined as a raw data structure. The server application validates, formats, and stores the data in the database.

WAHASTRAT system specification:

- Decagon EC-5 sensor for volumetric water content determination Davis sensors
- Solar power
- Non-maintenance battery - can supply the station for 30 days when there is little or no sunlight
- GSM modem
- Communication between the station and the server is done via HTTP protocol

WAHASTRAT system, like most environmental monitoring systems uses a distributed sensor-based framework (WSN), and IoT connects them to the Internet to make data available at all times. The main roles of these systems are monitoring time series, data tracking, and recording. In WAHASTRAT system we implement IoT concept combined with GIS to feed the information

system or to use data in real-time and spatial context, (Figure 3) WAHASTRAT GoT.

GoT implement for WAHASTRAT currently is used primarily to assess the risk to agricultural production. Availability of such data is invaluable to modern agriculture, and may be used to make decisions about irrigation during drought periods, or drainage needs and capability of soil to absorb excess water during the prolonged periods of rain. All those data is used mainly in off-line regime. All these assessments are also used to make business decisions in various businesses, for example about type of plants appropriate for given location, about insurance premium for crop insurance.

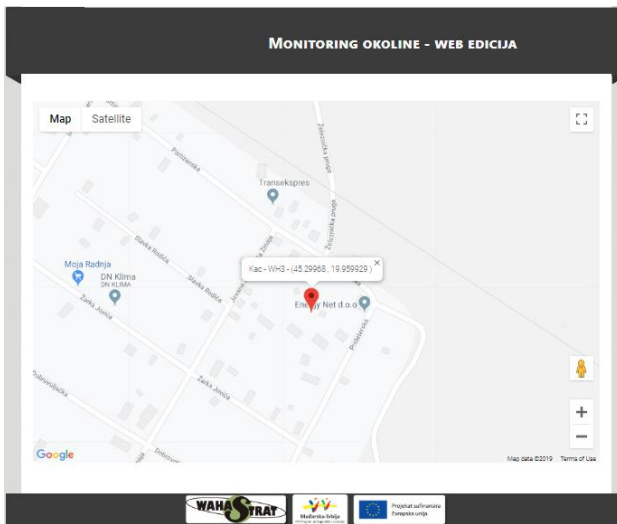

Figure 3 – WAHASTRAT GoT (wahastrat.vizugy.hu)

All this data is used after the acquisition, with more or less delay. Our idea is that by inserting new ad-hoc climatological stations without a known location in advance, and interpreting the results in real-time, we can achieve an extension of the functionality of the already installed system. In this way, the application of IoT concept combined with GIS relates to the use of several devices connected to a server in order to obtain a lot of information to feed the information system.

However, the WAHASTRAT system does not take any special action in real-time and GoT concept offer that opportunity. There are many events that should be recognized. If such events are extracted during the data analysis, it may serve as a trigger for automated recovery process. Such a process can be easily modeled, deployed and when necessary upgraded by using process aware software solution such as BPM processing engines. In [12] we discuss a BPMN model of automated response procedure triggered by error or warning events extracted during data analysis.

## V. CONCLUSION

As data acquisition constantly evolving, the problem is how to use remote sensing technologies with a large number of in situ observations to get a complete picture of the environment. When this is done a general outline of a city or parts of it can be integrated with these individual measurements into the concept of a smart city.

With the expansion and growth of cities, making them smart has become crucial to increasing the quality of life for citizens. IoT was presented as the best approach to make the city smart. It can be applied in various scenarios such as the above mentioned environmental monitoring, gas concentration, water and air quality, etc. A number of related facilities are required to achieve these goals. In addition, related ICT industries need to be explored and developed in parallel to promote IoT technologies.

## REFERENCES

- [1] Kamilaris A., Ostermann F. O., 2018, "Geospatial Analysis and the Internet of Things", International Journal of Geo-Information, International Society for Photogrammetry and Remote Sensing, MDPI
- [2] Basanow J., Neis P., Neubauer S., Schilling A., Zipf A., 2010, "Towards 3D Spatial Data Infrastructures (3D-SDI) based on open standards – experiences, results and future issues", Berlin: Springer.
- [3] Cox, S., 2011, "Observations and Measurements - XML Implementation", Berlin: Springer.
- [4] Fox, P., McGuinness, D.L., Cinquini, L., West, P., Garcia, J., Benedict, J.L., Middleton, D., 2009, "Ontology-supported scientific data frameworks: The Virtual Solar-Terrestrial Observatory experience", Computers & Geosciences 35(4), 724-738
- [5] Fensel, A., Tomic, S., Kumar, V., Stefanovic, M., Aleshin, S.V., Novikov, 2012, "Semantic Smart Home System for Energy Efficiency", Informatik-Spektrum 36(1), 46-57, Berlin: Springer.
- [6] Kemec S., Duzgun H. S., Rahman A. A., Zlatanova S., Coors V., 2007, "Use of 3D Visualization in Natural Disaster Risk Assessment for Urban Areas", Berlin: Springer.
- [7] Kuhn, W., 2009, "A Functional Ontology of Observation and Measurement", pp. 26-43. No. 5892, Berlin: Springer.
- [8] Šećerov I., Dolinaj D., Pavić D., Milošević D., Popov S., Živanov Ž., 2019, "Environmental Monitoring Systems: Review and Future Development", Wireless Engineering and Technology, WET
- [9] Stavropoulos, T.G., Vrakas, D., Vlachava, D., Bassiliades, N., 2012, "BOnSAI: A Smart Building Ontology for Ambient Intelligence", New York: ACM.
- [10] Stollberg B., Zipf A., 2010, "OGC Web Processing Service Interface for Webservice Orchestration Aggregating Geoprocessing Services in a Bomb Threat Scenario, Berlin: Springer.
- [11] Pinheiro, P., McGuinness, D.L., Santos, H., 2015, "Human-Aware Sensor Network Ontology: Semantic Support for Empirical Data Collection", Bethlehem: PA.
- [12] Popov S., Zarić M., Čosić Đ., 2017, "Pairing BPM and IoT For Sensor Error Discovery and Recovery Automation", 7th International Conference on Information Society and Technology

# REGULAR PAPERS

# Using Graph Databases for Querying and Network Analysing

Blagoj Ristevski

Department of Software Engineering and Information Systems  
Faculty of Information and Communication Technologies - Bitola  
“St. Kliment Ohridski” University - Bitola  
Ul. Partizanska bb 7000 Bitola, Republic of Macedonia  
blagoj.ristevski@uklo.edu.mk

**Abstract** - Huge amounts of data are generated and used on a daily basis. This has led to the new concepts: big data and hybrid databases that are becoming more popular and promising. Thus, there is a need of integrating and storing data from various heterogeneous data sources. With the growth of data size, NoSQL databases have outperformed traditional relational databases for analysis, access and querying on big data. Relational databases store data in multiple tables and they are not suitable to represent numerous kinds of complex relationships among entities, particularly in computer networks, biological and social networks. On the other hand, graph databases rely on graph structure and are able to handle complex relationships. These databases use nodes representing entities and edges representing relationships, to present and store data. Graph database are very suitable for storing and querying heavily interconnected data, especially for large-scale network data. In this paper, Neo4j database and Cypher query language are described, and their using for analysis, querying and effectively mining of biological network's data.

**Keywords:** databases, NoSQL databases, omics data, graph databases, complex biological networks.

## I. INTRODUCTION

Nowadays, a huge amount of data is created on a daily basis. These datasets can be a physical group of values of different attributes. To discover a helpful knowledge from these datasets, which is associated with relations between the attributes' values, numerous data mining algorithms can be applied on these datasets.

In relational databases, data are tabled and relationships among tables are achieved by foreign keys. The modeling of the relational databases requires obeying very strict rules and constraints that include primary key constraint and management, database integrity and database normalization.

In the big data area, creation of massive amounts of structured, non-structured or semi-structured data and application of data mining techniques requires another database models that will solve the challenges, which relational database model is not capable to resolve them in a suitable manner. Especially, the data that are suitable to be represented as networks and then to apply a proper

network analysis requires different models, such as a graph database model.

The data representation as a graph, establishing of the relationships, the simplicity in the query formulation, data visualization modules, interoperability, acceptance of different standard data formats and the real programming experience on a logical database design make the graph databases to overcome the relational databases [1].

Differently from the relational databases, in graph databases it is possible to have a disciplined number of multivalued attributes, such as node name, node number or array of different attributes for a single node. As an analogue of connection between different tables (relations) through the foreign keys in relational databases, in graph databases each node has a fixed number of incoming and outgoing edges called as indegree and outdegree of the node, respectively. Another advantage of the graph database is the possibility to apply different graph algorithms for numerous experiments in data mining [1].

In graph databases, the relationships between two nodes are established using typical query syntax. There are different plugins, packages or modules for data visualization that can be easily integrated with the graph database workflow. Graph data visualization is an analogue to the select queries in the relational databases [1].

The remainder of the paper is structured as follows Section II compares relational and NoSQL databases. The main characteristics of graph databases and Cypher – query language for analyzing and network analyzing are described in Section III. The application of graph databases for biological data is given in the subsequent section. The last section provides concluding remarks and direction for further application of graph databases.

## II. NOSQL DATABASES

Novel data storage systems, that are capable to deal with big data, are introduced and named as NoSQL databases. Many of NoSQL databases offer horizontal scalability and higher availability than relational databases [4].

As big data and hybrid database system are becoming popular, the popularity of NoSQL database is raising [2]. Companies and research organizations and institutes integrate relational and NoSQL databases. While relational databases are used to deal with small and middle scale data, NoSQL databases are used as system back-end data pool for batched operations for reading and writing, as well as analysis [2].

The recent advances of the social networks and modern Web with heterogeneous unstructured, semi-structured, continuous and high-order data require new database models that are different from relational database [9]. NoSQL databases show potential to deal with such datasets. There are four main group of NoSQL databases: graph, key-value, document and column family databases [9].

In key-value databases, data are stored in associative arrays and complex maps between sets of objects are allowed. In document databases, data are stored in JSON documents and they can deal with large document collections. Column family databases store data in tables with very long rows grouped into column families [9].

In graph databases, a graph is consisted of nodes, edges and properties. Nodes, that represent objects, contain properties in key-value pairs. Edges, that represent directed and labeled connections, have a start and an end node. Edges contain properties in key-value pairs, too [9]. Graph analytics and graph models can be extended to fuzzy graphs. In a fuzzy graph an edge between two nodes exists with a certain probability. This graph model extension has resulted with development of a fuzzy version of Cypher for graph querying [9].

### III. CHARACTERISTICS OF GRAPH DATABASES

One of the main drawbacks of the relational model is its limitation to explicitly cover requirement semantics [11]. Where relational databases are optimized to deal with aggregated data, graph databases are very suitable to handle highly connected data. A common graph type supported by most graph databases is the property graph. Property graphs are labeled, attributed and directed multi-graphs [11]. The graph database design is suitable to construct predictive models and to detect correlations and patterns that exist in the data.

Graph databases support storage of unstructured data that can be integrated through contemporary forms of data interchange by using REST and JSON interfaces. They provide a natural manner for graph storage as well as for graph analytics such as link prediction and minimum spanning trees [9].

A graph database is represented by graph consisted of sets of nodes and edges. Nodes represent biological entities, whereas edges represent the connections or interactions. In addition, the nodes can have properties and nodes that have shared property can be comprehended that they are linked, as shown on Fig. 1.

Nodes linked through edges to an intermediate node indicate that they are sharing common property [5].

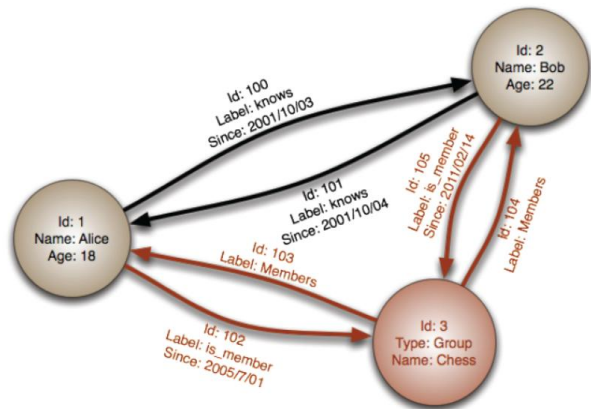

Figure 1: A graph with nodes and edges, where the edges represent the properties between the nodes [16].

The graph databases are optimized to store and query graph structures and huge amounts of data containing interconnected data, which are not suitable to be in represented by the relational databases [14]. Following characteristics make graph data to be the fastest growing category in database management systems [14]:

- Data representation as graph makes them to be quite intuitive.
- They support using new data types.
- They are able to store huge volume data in the order of petabytes.
- The information searching and data mining techniques are more optimized; especially they show high querying performances in very deep searches, compared to the relational databases.
- During development they can be easily adapted in regards of data updating and hence they are very agile.
- They are very suitable for highly interconnected data, such data in social networks, computer networks, biological networks and web semantics.

Examples of graph databases are: Neo4j, Allegro Graph, Hypergraph DB, Bitsy, GraphBase and TigerGraph [13].

Nowadays, with creation of huge amounts of unstructured data and using big data analytics applications in biology, as well as in many other domains, Neo4j is a very suitable platform that provides solutions to numerous challenges in databases, data science and data mining.

One of the best representatives of graph databases is Neo4j [14]. The horizontal scalability in Neo4j allows easily adding new nodes in a database. It has its own query language – Cypher. Cypher query language provides deletion, insertion and creation of the basic



elements: nodes, edges and properties. The data storage is disk-based via proprietary file systems. It fully supports ACID (atomicity, consistency, isolation and durability) transaction properties and it has very intuitive and accessible interface.

Graph databases, whose schemas are free and flexible, by using graph model can effectively store, manage, update data and relationships [7]. Most commonly used graph database is Neo4j that is a robust and supports ACID transaction properties [7]. The data of Neo4j are stored on a disk and they are loaded into memory when a query is executed and then cached. For a Neo4j high availability (HA) cluster, each Neo4j instance data are consistent and the corresponding queries are based on each Neo4j instance of independent occupied memory space [7].

Neo4j graph database can be run as desktop database or database server and uses Cypher, an SQL-like versatile query language for graphs. Neo4j has user friendly interface that can show results as graphs or tables and has interfaces to the essential programming languages used in bioinformatics: R, Java and Python [5]. Hölsch et al. has shown that Neo4j is more efficient for path queries that do not filter on specific types of edges, differently for analytical queries, where the relational database has shown better performances [8].

To retrieve information out of a graph, a traversal is required. A graph traversal, that includes “walking” along the elements of a graph, is a crucial operation for data retrieval [11]. Differently from the SQL queries, the traversal is a localized operation.

For instance, Cypher graph query language has a function for finding shortest paths, disregarding the edge weights. This leads to a huge speed improvement when Neo4j finds the shortest path with no length constraint, compared to SQL querying [3]. The result from a SQL query is available only in tabular form, but graph-view results are not available. In Cypher query language the results can be shown as graphs and as tables [13].

#### IV. GRAPH DATABASES FOR BIOLOGICAL DATA

The absence of database schema makes Neo4j to be much more flexible, but it eliminates the data interoperability standards, which can be solved by introducing consistent semantics [5]. Moreover, the Cypher graph query language in the biological graph databases is able to generate a plethora of common biologically-based queries [5].

The main concerns in big omics data in biology are dealing with their rich semantics and complexity. The principles for graph database modelling are very similar to those employed for design of ontology. The ontology in graph databases is analogous to the schema in a relational database.

One of the major goals in biology is to understand complex interactions among entities that exist and contribute to the living cell functions [6]. These

interactions can be measured experimentally and are stored in heterogeneous data formats. Revealing of these complex interactions among these voluminous heterogeneous biological data is very difficult task. Although biological network data can be stored in relational databases, multiple join queries make them to be too computational demanding and to have too complex design.

Currently, to understand molecular basis of various disease, huge amounts of high-throughput data, so called omics data, are generated. Understanding the underlying diseases’ processes requires integration of numerous heterogeneous data and then to study the complex interactions and relationships among entities (i.e., genes, proteins, non-coding RNAs, metabolites). These relationships might belong to the different types, such as participation (a gene/protein participates in a particular pathway), sequence similarity (one protein is similar to another) or interactions (one protein/gene interacts with another protein/gene) [5]. In such a way, these relationships depict complex biological networks.

Information contained in the biological data is typically highly connected, semi-structured or unstructured, as well as unpredictable. Therefore, these data features are crucial to choose a suitable manner to represent and query the complex biological networks [5]. Moreover, the amount of information associated to a particular entity may not be uniform, which makes the standard relational database model to be non-suitable to handle cases with a large number of uniform entries associated with a limited number of data types. In relational database model all data should be transformed to predefined schema, which makes concerns for representing of semi-structured and unstructured data. Biological research can be unpredictable, especially when new techniques or new data resources are introduced. To add these new data into a relational database that can be very important to understand the roles and involvements of particular biological entries in a particular pathway, re-design of the database schema is needed, which is a complex and demanding task [5]. Graph databases are capable to represent non-uniformly distributed, highly connected, semi-structured and unpredictable data which are founded in the biological research studies [5]. The graph databases are scalable and allow adding new data types.

One approach to detect new oncogenes is the extraction of subgraphs with four nodes from a protein-protein interaction network that contain transcription of the gene expressions [15]. As a result of the huge amounts of subgraphs formed by this complex network of interactions, the processing and querying when relational databases are used is very time demanding and not effective.

Genome corresponds to the whole genetic material of an organism, whereas the transcriptome determines which genes are expressed and these expression levels change during the organism’s life. Both genome and

transcriptome are related to the proteins that demonstrate big variations among the cells of a particular organism [15]. The proteome of an organism analyzes the proteins, enables identification of proteins and understanding of their functions.

Proteome is the total set of proteins, their variations and modifications with other proteins and interactions network.

The transcriptome is the set of all RNA messenger transcriptions produced within the cells of a tissue. To obtain transcriptome data, a high-throughput technology is used to determine how the transcriptome changes in time lags or in a determined biological state of the organism [15]. Thus, transcriptome allows clarifying a disease pathogenesis.

The protein-protein interaction networks are interactome networks consisted of all interaction among proteins that happen in a variety of protein's physiologically relevant concentration [15].

Mattioli and Gubitoso have shown that the identification and detection of four-node networks motifs by using graph database was the optimal option [15].

Shoshi et al. have developed a Neo4j graph database called GenCoNet that integrates different associations between genes, diseases, variants and drugs for the essential hypertension and bronchial asthma [10].

Have and Jensen have proposed an integrated graph database for biological data, called BioGraphDB [12]. BioGraphDB can be applied for various clinical research analysis, such as:

- analysis of gene functions and pathways
- analysis of protein motifs linked to cellular pathway
- analysis of tumor-suppressor/oncogenic microRNA
- target analysis of differentially expressed microRNAs in cancer.

To analyze the forehead-mentioned biological network interactions/pathways, various biological database should be used such as: Entrez gene, RefSeq, Gene Ontology (GO), Reactome, UniProt, miRNA-target interactions, mirBase and mirCancer [12].

## V. DISCUSSION AND FUTURE WORK

Graph databases have outperformed relational databases when working with data where data topology or interconnectivity is important [11].

Graph databases are very suitable to apply for biological and semantic networks and recommender systems. Bioinformatics uses graph databases to represent complex biological networks that include proteins, genes, enzymes, metabolites and microRNAs. A typical example is the open source bioinformatics platform Bio4j that uses

Neo4j as a framework. Bio4j has integrated data from diverse sources (Gene Ontology, RefSeq, UniREF, Uniprot KB, NCBI Taxonomy, ExPasy Enzyme Database) into one data source.

Moreover, social networks, such as LinkedIn and Facebook and online airplane booking companies utilize graph databases, too [6].

Furthermore, for storing of highly-interconnected data, voluminous and unstructured data graph databases should be used. The developed software solutions should be based on the graph databases and their properties, particularly when those solutions are focused on social network analysis and biological big omics data.

## ACKNOWLEDGEMENT

This paper was supported by the Ministry of Education and Science of the Republic of Macedonia and the Ministry of Science and Technology (MOST) of the Government of the People's Republic of China within the bilateral project "Modeling, Simulation and Analysis of Complex Networks in Biology".

## REFERENCES

- [1] Johnpaul, C. I., and Tojo Mathew. "A Cypher query based NoSQL data mining on protein datasets using Neo4j graph database." In *2017 4th International Conference on Advanced Computing and Communication Systems (ICACCS)*, pp. 1-6. IEEE, 2017.
- [2] Liao, Ying-Ti, Jiazheng Zhou, Chia-Hung Lu, Shih-Chang Chen, Ching-Hsien Hsu, Wenguang Chen, Mon-Fong Jiang, and Yeh-Ching Chung. "Data adapter for querying and transformation between SQL and NoSQL database." *Future Generation Computer Systems* 65 (2016): 111-121.
- [3] Have, C. T., & Jensen, L. J. (2013). Are graph databases ready for bioinformatics?. *Bioinformatics*, 29(24), 3107.
- [4] Gessert, Felix, Wolfram Wingerath, Steffen Friedrich, and Norbert Ritter. "NoSQL database systems: a survey and decision guidance." *Computer Science-Research and Development* 32, no. 3-4 (2017): 353-365.
- [5] Lysenko, Artem, Irina A. Roznovãt, Mansoor Saqi, Alexander Mazein, Christopher J. Rawlings, and Charles Auffray. "Representing and querying disease networks using graph databases." *BioData mining* 9, no. 1 (2016): 23.
- [6] Yoon, Byoung-Ha, Seon-Kyu Kim, and Seon-Young Kim. "Use of graph database for the integration of heterogeneous biological data." *Genomics & informatics* 15, no. 1 (2017): 19.
- [7] Huang, Hongcheng, and Ziyu Dong. "Research on architecture and query performance based on distributed graph database neo4j." In *2013 3rd International Conference on Consumer Electronics, Communications and Networks*, pp. 533-536. IEEE, 2013.
- [8] Hölsch, Jürgen, Tobias Schmidt, and Michael Grossniklaus. "On the performance of analytical and pattern matching graph queries in neo4j and a relational database." In *EDBT/ICDT 2017 Joint Conference: 6th International Workshop on Querying Graph Structured Data (GraphQ)*. 2017.
- [9] Drakopoulos, Georgios, Aikaterini Baroutiadi, and Vasileios Megalooikonomou. "Higher order graph centrality measures for Neo4j." In *2015 6th International Conference on Information, Intelligence, Systems and Applications (IISA)*, pp. 1-6. IEEE, 2015.
- [10] Shoshi, Alban, Ralf Hofestãdt, Olga Zolotareva, Marcel Friedrichs, Alex Maier, Vladimir A. Ivanisenko, Victor E. Dosenko, and Elena Yu Bragina. "GenCoNet—a graph database for the analysis of comorbidities by gene networks." *Journal of integrative bioinformatics* 15, no. 4 (2018).

**International conference on Applied Internet and Information Technologies  
October 3-4, 2019, Zrenjanin, Republic of Serbia**

---

- [11] Miller, Justin J. "Graph database applications and concepts with Neo4j." In *Proceedings of the Southern Association for Information Systems Conference, Atlanta, GA, USA*, vol. 2324, no. S 36. 2013.
- [12] Fiannaca, Antonino, Massimo La Rosa, Laura La Paglia, Antonio Messina, and Alfonso Urso. "BioGraphDB: a new GraphDB collecting heterogeneous data for bioinformatics analysis." *Proceedings of BIOTECHNO* (2016).
- [13] Jaiswal, Garima, and Arun Prakash Agrawal. "Comparative analysis of Relational and Graph databases." *IOSR Journal of Engineering (IOSRJEN)* 3, no. 8 (2013): 25-27.
- [14] Guia, José, Valéria Gonçalves Soares, and Jorge Bernardino. "Graph Databases: Neo4j Analysis." In *ICEIS (I)*, pp. 351-356. 2017.
- [15] Mattioli, Diogo, and Marco D. Gubitoso. "Application of Graph Database in the Storage of Heterogeneous Omics Data for the Treatment in Bioinformatics." In *Proceedings of the 2018 10th International Conference on Bioinformatics and Biomedical Technology*, pp. 51-56. ACM, 2018.
- [16] Goel, Ankur. *Neo4j cookbook*. Packt Publishing Ltd, 2015.

# Analysis and Simulation of Biological Complex Networks

B. Ristevski and S. Savoska

Department of Software Engineering and Information Systems  
Faculty of Information and Communication Technologies – Bitola  
“St. Kliment Ohridski” University - Bitola  
Ul. Partizanska bb. 7000 Bitola, Republic of North Macedonia  
blagoj.ristevski@fikt.edu.mk, snezana.savoska@fikt.edu.mk

**Abstract** - Modeling, simulation and discovering of interactions and regulatory mechanisms among networks' nodes, is still a challenging task in the analysis of complex networks in many domains, such as biology, computer networks, social networks, physics and power systems analysis. Particularly, complex networks' analysis in biology can provide a very significant insight to the relevant information for the biological processes, such as diseases, interactions and regulatory mechanisms. The aim of this paper is to describe and survey the application of complex network analysis in biology to comprehend the relationships in the complex dynamic processes and interactions in biological networks and their properties.

**Keywords:** Network Science, Applied Informatics and Simulation, Complex Networks, Bioinformatics, Big Data.

## I. INTRODUCTION

Nowadays in the era of big data, to understand molecular basis of various disease, huge amounts of high-throughput data are created. Understanding the underlying diseases' processes requires integration of numerous heterogeneous data and then to study the complex interactions and relationships among entities (i.e., genes, proteins, non-coding RNAs, metabolites). These relationships might belong to different types and they depict complex biological networks.

To analyze, describe, control and monitor many real systems in biology, network theory, power systems, engineering, physics, social science, computer science, network analysis is a very promising and powerful method. The organization and behavior of complex systems can be represented by graphs and collection of automata [3]. Graphs are suitable to deal with the static properties of the complex systems. To study nonlinear dynamics of the systems that are represented with graphs, networks node should have discrete states such as Boolean networks.

Networks provides very suitable and efficiently representation of large amounts of data, particularly those who have graph-based structures. The structure of many real systems is a graph that contains modules, often named as communities, consisted of cluster of densely interconnected nodes. The nodes within a module are densely linked, while nodes that belong in different communities are sparsely linked. The entities (nodes) in

the same community represents functional units of the network that share similar behavior, common characteristics, interests, or are involved in the similar activities.

Study of the network structure enables discovering of several organization fundamentals of complex systems, the community structure and the network node degree distribution, whether the networks are scale-free, random or small-world networks.

The edges in a complex network depict the interaction between nodes. As a result of these interactions, perturbations of one node can trigger off changes in the state of the other nodes [7]. These state alterations are important to control a network when it transits from an initial state to a desired state by handling the state variables of a subset of nodes.

Such control of the complex networks plays a key role in the biological networks, such as protein-protein interaction networks, gene regulatory networks, cellular networks, brain networks, microRNA-mediated regulatory networks, metabolic networks etc.

The remainder of the paper is structured as follows. Section II describe the common network properties, whereas the link prediction and community detection are described in the subsequent section. The models and software tools for modeling and analysis of biological networks are depicted in Section IV The last section provides concluding remarks and direction for further work in analysis of complex networks that are based on big omics data.

## II. NETWORK PROPERTIES

To study complex networks, network properties such as diameter of the graph, nodes' degree distribution, centrality measures, clustering coefficient, network motifs and graphlets should be taken into account.

Let  $G(V, E)$  be a graph, where  $V$  is the set of vertices and  $E$  is the set of undirected edges and  $u, v \in V(G)$  are adjacent. The diameter of a graph is the maximal distance

$$d(u, v) | \forall u, v \in V(G)$$

The clustering coefficient  $C$  of a network is the average of  $C_v$  for all  $v \in V(G)$  in the network, and  $C_v$  is the clustering coefficient for node  $v$ :

$$C_v = \frac{2E_v}{n_v(n_v - 1)}$$

where  $E_v$  is the number of edges between all the neighbors of  $v$ , and  $n_v$  is the number of neighbors of  $v$

The clustering coefficient measures how connected are the neighbors of any node. The degree centrality measures the importance of the role vertex  $u$  plays in a graph by measuring the number of interactions  $u$  is involved in. Let the degree of the node (vertex)  $u$  be denoted as  $d(u)$  and given by:

$$d(u) = \sum_{i \in V(G)} e_{ui}$$

where  $e_{ui} \in E(G)$ . The degree centrality of vertex  $u$  is defined as  $Cd(u) = d(u)$

The betweenness centrality measures the importance of vertex  $u$  in a graph by measuring the proportion of paths between other vertices in  $G$  [6]. The betweenness centrality of  $w$  is given by the following equation:

$$BC(w) = \sum_{u,v \in V} \frac{S_{uw}(w)}{S_{uv}}$$

where  $S_{uv}$  is the number of shortest paths between  $u$  and  $v$ .

Network motifs are small sub-graphs in a network such that when compared to randomized networks, their structures appear significantly more. Different motifs are found in different complex networks (the feed-forward loop, a 3-node motif etc.)

Graphlets are all non-isomorphic connected induced graphs on a certain number of vertices, and by definition, they have the ability to capture all the local structures on a certain number of vertices.

For instance, when gene regulatory networks are studied, several properties should be considered such as sparseness, scale-free topology, modularity and structurality of the network. The gene regulatory networks should be sparse, which means a limited number of genes regulates genes. Some genes in the network called "hubs" can regulate many genes, i.e. the out-degree of the nodes is not limited. Another important feature is the scale-free topology. Scale-free networks have the power distribution function of the connectivity degree. This property provides the robustness of the networks regarding the random topology changes. Structures with small connectivity follow the regulatory hierarchy. The structurality allows network decomposition into basic modular elements composed of several genes, called network motifs. The network modularity refers to the existence of clusters of highly co-expressed genes and genes with similar function.

Centrality measures for complex networks are used to identify important elements of the networks through their structural topological properties [6]. Each centrality measures cover a different aspect of vertex local or global importance in a given network. Complex network studies have shown that real complex networks have several important properties such as small-world effect, scale-free topology and community organization [6].

Real networks have additional properties that are not associated with their node degree distributions, such as degree correlations, local clustering and community structure [7]. Many real networks have nodes with one degree, so-called dead ends that can erode the complex system stability.

### III. LINK PREDICTION AND COMMUNITY DETECTION IN COMPLEX NETWORKS

The high-order structures are small network subgraphs that are referred as network motifs. Network motifs such as feed-forward loops, two-hop paths, open bidirectional wedges and triangular motifs are network building blocks that are crucial to understand fundamental network functions, patterns and properties [11].

Motif discovery is one of the essential research fields in complex networks in biology. These networks subgraphs that are usually considered as buildings blocks, Because of the algorithms' complexity, heuristic approaches are commonly used to discover networks motifs.

Nodes belonging to the same community in a network have a higher probability to share functional properties and hence detection of community can discover new functional relationships or characteristics of that network. Community detection algorithms search for the optimal community structure that represents network characteristics as better as possible [1]. To solve community detection problem, many heuristic algorithms are proposed such as those based on simulated annealing, swarm intelligence, genetic and evolutionary algorithms, generational genetic algorithm (GGA+).

For community detection, two main types of algorithms are usually used: edge betweenness-based algorithm and modularity-based algorithm. The edge-betweenness value of an edge  $e$  in a network/graph  $G$  is the fraction of all pairwise shortest paths that pass through  $e$ . When an edge  $e$  that bridges a graph is removed and graph is disconnected, that edge  $e$  has a very high edge-betweenness value. Let a graph  $G$  is divided into  $k$  clusters and  $e_{ii}$  is the ratio of edges in cluster  $i$  and  $a_i$  is the fraction of edges with at least one end in the  $i$ -th cluster. The graph modularity is calculated by the following equation:

$$Q = \sum_{i=1}^k (e_{ii} - a_i^2)$$

When the percentage of the edges within the clusters are higher than ones with one node in a cluster, a higher value of  $Q$  is expected. The value of  $Q$  approaches to 1 when there are only few inter-cluster edges [8].

The graphs used to model complex networks are large and hence many problems in these networks are NP-hard, which make them to use suitable heuristic algorithms [8].

Connectivity in a graph denotes that any two of its nodes are connected by a path. A graph is  $k$ -connected if there are at least  $k$  disjoint paths between any two nodes in the graph. When the value of  $k$  is higher, the graph becomes more strongly connected. That means that networks with higher connectivity values  $k$  are more reliable and tolerant of node failures, compared to the networks with lower  $k$  values.

To understand organization of a network, prediction of the missing links between networks nodes is needed. The link prediction problem is very challenging in contemporary computer science. The main goal of link prediction is to estimate the existence likelihood of unobservable links based on the known network topology and node attributes [5]. In complex network analysis, link prediction is used to reveal missing parts (e.g., of biological and social networks).

To compare network properties, several commonly used network models should be considered, such as Erdős-Rényi random graphs, Barabási-Albert scale free networks, scale free networks that model gene duplication and mutations, geometric random graphs, geometric graphs that model gene duplication and mutations, stickiness-index based networks and generalized random graphs with the same degree distribution as the data [12].

Comparing of biological networks as a whole or partly is used to find their similarities. A comparison between two networks is made in pairwise alignment, whereas comparison of many networks in multiple alignment [8]. Entire networks are compared for similar species in global alignment, while similar subnetworks for diverse species are compared in local alignment [8]. When assessing similarity of two biological networks, topological similarity or node similarity can be calculated.

#### IV. MODELS AND TOOLS FOR MODELLING AND ANALYSIS OF BIOLOGICAL NETWORKS

Biological complex networks are consisted of nodes that represent biological entities, while edges represent the interactions among them. In protein-protein interaction networks, proteins are represented by nodes, as shown on Fig.1. Genes and interacting proteins are nodes in gene regulatory networks. Metabolic networks represent biochemical reactions in the cell that generate metabolism [8]. Besides these networks within the cells, brain networks, neural networks, phylogenetic networks are another type of biological networks outside the cell.

Protein-protein interaction networks are present outside cells' nucleus and detecting clusters and network motifs and aligning two networks are challenging tasks in biological complex network analysis. Network motifs are assumed to have basic functional and building blocks of an organism. Finding similar networks motifs in two or more organisms may be a clue for having common

ancestry [8]. While network alignment between two or more networks is usually used to compare different networks and shows the similarities between networks.

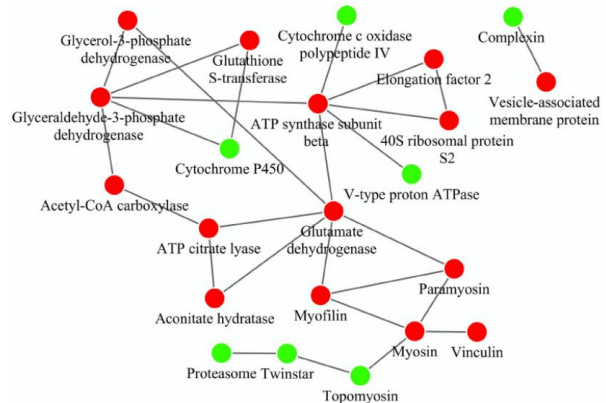

**Figure 1:** Protein-protein interaction network [14].

Clustering in biological networks is employed to find dense regions of significant biological activity that show sometimes diseases states of a particular organism [8]. The clustering in biological networks can be categorized as density-based clustering, hierarchical clustering, spectral clustering and flow-based clustering. A survey of computational approaches for reverse engineering of micro-RNAS-mediated and gene regulatory networks are given in [13], whereas computation approaches for detection of protein complexes from protein-protein interaction networks are given in [19].

Many tools are developed to model, simulate and analyze complex networks with highlight to their application in biology. Since the beginning of the 1990s, Petri nets became a powerful tool to model and simulate complex biological and biochemical networks [2] [4].

Petri nets formalism is suitable to model, simulate and analyze processes that occur in the complex systems. Their application for modeling of biological networks started in the early 1990s. A Petri net  $PN = (P, T, F, W, m_0)$  is consisted of a finite set of places ( $P$ ) and finite set of transitions ( $T$ ) that are connected by directed arcs ( $F$ ), while  $F \subseteq (P \times T) \cup (T \times P)$  is a finite set of arcs [4]. The tuple  $(P, T, F)$  is called a net and  $W$  is the weight function of the Petri net. The places, transitions and arcs are represented by circles, rectangles and directed arrows, respectively. Places can contain tokens drawn as dots. When tokens are assigned to places, a Petri net is configured and  $m_0$  is Petri net's start configuration. When all pre-places represent more or equal token than the input arrow announced, then a transition has concession. If any transition has concession the transition can fire [4]. When the elements of a Petri net have more properties, then more types of Petri nets can be defined.

Functional Petri net are those Petri nets whose arcs can represent functions and tokens can be represented by nonnegative integer numbers. When a transition can be controlled by a timer, timed Petri nets are introduced. Stochastic Petri nets are timed Petri net where each transition is provided by a random delay instead a fixed

value. Continuous Petri nets are those nets that use real positive numbers, instead integer numbers [4]. To model biological processes, a hybrid Petri nets are introduced, which have discrete and continuous transitions and places, as well as inhibitory and test arcs, as shown on Fig. 2. Such transitions, places and arcs provide interpretation of concentration of different biological entities, reactions, pathways and regulations. Another extension of the hybrid Petri nets by introducing hybrid functional Petri nets [2].

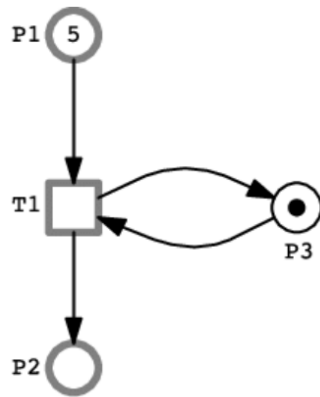

**Figure 2:** A Hybrid Petri net consisted of two continuous places, one discrete place and one continuous transition [15].

Very suitable software packages for modeling, analysis and simulation of complex networks in biology are Matlab with its toolboxes [17], R (programming language) with its R packages [18] and Cytoscape with its plugins [16] [9].

## V. CONCLUSION AND FUTURE WORK

To expedite the study of various biological processes, the analysis of network structural and graph theoretical properties are very important. To study properties of biological complex networks, as a further work development of suitable heuristic, parallel and distributed algorithms is needed.

With recent advances in high-throughput technologies, a huge amount of biological omics data is generated. To store, analyze and query these biological data sets, graph databases are very promising data model. As a further work, more software applications and tools based on graph databases should be developed. Using graph databases can improve the biological network analysis, particularly the understanding the interactions among biological entities (nodes).

## ACKNOWLEDGEMENT

This paper was supported by the Ministry of Education and Science of the Republic of Macedonia and the Ministry of Science and Technology (MOST) of the Government of the People's Republic of China within the

bilateral project "Modeling, Simulation and Analysis of Complex Networks in Biology".

## REFERENCES

- [1] Guerrero, Manuel, Francisco G. Montoya, Raúl Baños, Alfredo Alcayde, and Consolación Gil. "Adaptive community detection in complex networks using genetic algorithms." *Neurocomputing* 266 (2017): 101-113.
- [2] Hofestädt, Ralf. "Advantages of Petri-Net Modeling and Simulation for Biological Networks." *Journal of Bioscience, Biochemistry and Bioinformatics* 7, no. 4 (2017): 221-229.
- [3] Gates, Alexander J., and Luis M. Rocha. "Control of complex networks requires both structure and dynamics." *Scientific reports* 6 (2016): 24456.
- [4] Hofestädt, Ralf, Christoph Brinkrolf, and Philo Reipke. "OMPetri: A New Petri Net Simulation Environment Based on OpenModelica." In *Proceedings of the 2018 10th International Conference on Bioinformatics and Biomedical Technology*, pp. 57-61. ACM, 2018.
- [5] Lü, Linyuan, Liming Pan, Tao Zhou, Yi-Cheng Zhang, and H. Eugene Stanley. "Toward link predictability of complex networks." *Proceedings of the National Academy of Sciences* 112, no. 8 (2015): 2325-2330.
- [6] Grando, Felipe, Diego Noble, and Luis C. Lamb. "An analysis of centrality measures for complex and social networks." In *2016 IEEE Global Communications Conference (GLOBECOM)*, pp. 1-6. IEEE, 2016.
- [7] Yan, Gang, Georgios Tsekenis, Baruch Barzel, Jean-Jacques Slotine, Yang-Yu Liu, and Albert-László Barabási. "Spectrum of controlling and observing complex networks." *Nature Physics* 11, no. 9 (2015): 779.
- [8] Erciyes, K. *Guide to Graph Algorithms*. Springer International Publishing, 2018.
- [9] Kucera, Mike, Ruth Isserlin, Arkady Arkhangorodsky, and Gary D. Bader. "AutoAnnotate: A Cytoscape app for summarizing networks with semantic annotations." *F1000Research* 5 (2016).
- [10] Iyer, Swami, Timothy Killingback, Bala Sundaram, and Zhen Wang. "Attack robustness and centrality of complex networks." *PLoS one* 8, no. 4 (2013): e59613.
- [11] Benson, Austin R., David F. Gleich, and Jure Leskovec. "Higher-order organization of complex networks." *Science* 353, no. 6295 (2016): 163-166.
- [12] Yaveroğlu, Ömer Nebil, Noël Malod-Dognin, Darren Davis, Zoran Levnajic, Vuk Janjic, Rasa Karapandza, Aleksandar Stojmirovic, and Nataša Pržulj. "Revealing the hidden language of complex networks." *Scientific reports* 4 (2014): 4547.
- [13] Ristevski, Blagoj. "Overview of computational approaches for inference of microRNA-mediated and gene regulatory networks." In *Advances in Computers*, vol. 97, pp. 111-145. Elsevier, 2015.
- [14] Wang, Hui, Keke Wu, Yan Liu, Yunfeng Wu, and Xifeng Wang. "Integrative proteomics to understand the transmission mechanism of Barley yellow dwarf virus-GPV by its insect vector *Rhopalosiphum padi*." *Scientific reports* 5 (2015): 10971.
- [15] Herajy, Mostafa, Fei Liu, and Monika Heiner. "Efficient modelling of yeast cell cycles based on multisite phosphorylation using coloured hybrid Petri nets with marking-dependent arc weights." *Nonlinear Analysis: Hybrid Systems* 27 (2018): 191-212.
- [16] Shannon P, Markiel A, Ozier O, Baliga NS, Wang JT, Ramage D, Amin N, Schwikowski B, Ideker T. Cytoscape: a software environment for integrated models of biomolecular interaction networks. *Genome Research* 2003 Nov; 13(11):2498-504
- [17] MATLAB Release 2019b, The MathWorks, Inc., Natick, Massachusetts, United States.
- [18] R Core Team (2013). R: A language and environment for statistical computing. R Foundation for Statistical Computing, Vienna, Austria. URL <http://www.R-project.org/>.
- [19] Li, Xiaoli, Min Wu, Chee-Keong Kwoh, and See-Kiong Ng. "Computational approaches for detecting protein complexes from protein interaction networks: a survey." *BMC genomics* 11, no. 1 (2010): S3.

# Analyzing Consumer Spending Behavior Using Graph Databases

I.S. Hristoski\*\*, T.M. Spaseska\*, D.S. Odzaklieska\* and T.P. Dimovski\*\*

\* “St. Kliment Ohridski” University – Bitola, Faculty of Economics, Prilep, North Macedonia

\*\* “St. Kliment Ohridski” University – Bitola, Faculty of Information and Communication Technologies, Bitola, North Macedonia

{ilija.hristoski, tatjana.spaseska, dragica.odzaklieska, tome.dimovski}@uklo.edu.mk

**Abstract** - In order to ensure their financial stability, both families and individuals have to effectively manage their incomes and spending on a daily basis. Since these are based on various types of financial transactions, understanding spending behavior can significantly help people in making better decisions. However, this cannot be achieved by simply analyzing raw data. In this paper, we propose a methodology for analyzing financial transactions using graph databases, based on the analysis of the relationships found among the counterparts while carrying out financial transactions. Starting out from a corresponding E-R diagram depicting financial transactions, we first infer an equivalent graph database model. In order to demonstrate the effectiveness of such an approach, we then implement a test graph database in Neo4j, and by using Cypher query language (CQL), we make noteworthy insights about people's behavior in terms of how they perceive their finances through the process of money spending.

## I. INTRODUCTION

Financial management is one of the functional areas of general management, which refers to planning and controlling of financial resources of firms or individuals. It is an indispensable part of the economic and non-economic activities that lead to making relevant decisions regarding the efficient procurement and utilization of finances in a profitable manner. Financial management is traditionally separated into two basic functions: the acquisition of funds and the investment of those funds. The first function, also known as the financing decision, involves generating funds from internal sources or from sources external to the firm, at the lowest long-run cost possible. The second function, the investment decision, is concerned with the allocation of funds over time in such a way that shareholder wealth is maximized. In this paper, we put focus on the second function made by individuals, also known as consumer spending.

Effective financial management helps in achieving specific goals, both business-oriented and individual. On a firm level, its importance can be seen through the effects of financial planning, acquisition and proper use of funds, protecting funds towards achieving business goals, appropriate allocation of funds, in making sound financial decisions, in improving the profitability and increasing the value of the firm, in ensuring the economic growth and stability, and maximizing firm's wealth through promoting savings [1]. On an individual level, proper

financial management can contribute towards someone's financial stability, improving his/her standard of living, providing many investment opportunities, giving someone peace of mind and keeping someone financially stress free [2].

An important constituent part of financial management is consumer spending. Consumer spending or 'personal consumption expenditure', which can be regarded as opposed to personal saving, is another term for voluntary private household consumption, or the exchange of money for goods and services. Contemporary measures of consumer spending include all private purchases of durable goods (consumer goods that do not have to be purchased frequently and tend to last for at least three years), nondurables, and services. According to Kenton (2018), "many economists, especially those in the tradition of John Maynard Keynes, believe consumer spending is the most important short-run determinant of economic performance and is a primary component of aggregate demand" [3]. Consumer spending is a vital economic variable since the consumption of final goods (i.e., not capital goods or investment assets) is the result of economic activity, during which individuals ultimately use these goods and services to satisfy their own needs and wants. However, if consumers spend too much of their income, future economic growth could be compromised because of insufficient savings and investment. That's why modern governments and central banks often examine consumer spending patterns when considering current and future fiscal and monetary policies. Consumer spending is a significant investment indicator, too: the more money consumers spend at a given company, the better that company tends to perform. On the contrary, if consumers provide fewer revenues for a given business or within a given industry, companies must adjust by reducing costs, wages, or innovating and introducing newer and better products and services. Companies that do this most effectively, usually earn higher profits and, if publicly traded, tend to experience better stock market performance.

Capturing consumer spending patterns is also important at a micro-scale because by analyzing those patterns, individuals and families can carry out proper planning for their retirement days, college teaching fees, buying cars, houses, etc. Yet, just looking at the bank statements and shopping bills is not enough for consumers



to understand their spending patterns. The starting point in capturing consumer spending patterns is a financial transaction, which denotes a single exchange of money between a buyer and a seller. Since a systematic approach of organizing financial transactions into a corresponding database is needed as a key premise to successful capturing and analysis of consumer spending patterns, our approach is based on the utilization of graph databases in achieving this goal.

The paper is organized as follows. In Chapter 2, we provide an E-R diagram that encompasses the key entities, their attributes, and corresponding relationships needed for depicting a generic financial transaction. In addition, we briefly introduce the main rules of transforming the E-R diagram into an equivalent graph database model. Based on the implemented test graph database, in Chapter 3 we provide Cypher query language (CQL) programming codes needed to implement some basic analyses *vis-à-vis* the consumer spending behavior. The last chapter concludes.

## II. OBTAINING A GRAPH DATABASE MODEL FROM AN E-R DIAGRAM

Graph databases belong to the family of NoSQL databases; they address one of the great macroscopic business trends of today: “leveraging complex and dynamic relationships in highly connected data to generate insight and competitive advantage” [4]. Unlike the relational databases, which store data to efficiently store facts, graph databases store both facts and the relationships among the facts, making certain types of analyses more efficient and intuitive. Emerging as a major driver of innovation during recent years, graph databases have already exhibited many advantages over relational databases, like storing large volumes of data that might have little to no structure, sharing data across multiple servers in the cloud, speeding the development, boosting the horizontal scalability, demonstrating superior performances, and supporting iterative algorithms and other data mining and machine learning algorithms.

In order to establish a graph database framework for analyzing consumer spending behavior, we revert to a corresponding E-R diagram as a starting point (Figure 1). The E-R diagram consists of five entities: CUSTOMER, SELLER, PRODUCT, SUBCATEGORY, and CATEGORY. First three of them, along with the relationships that interconnect them, compose the basis of what is called a financial transaction, i.e. a specific customer, identified by his/her primary key *customerID*, buys a specific product (or service!), identified by its primary key *productID*, from a specific seller, identified by its primary key *sellerID*. The entity type CUSTOMER refers to each particular member of a given family. The entity type SELLER refers to any person or business entity (a vendor) that makes offers or contracts in order to make a sale to an actual or potential buyer (a customer), whilst the entity type PRODUCT refers to any merchandise (tangible good) or service (intangible good) that can be bought or sold, e.g. food, clothing, books, electricity supply, water supply, gas supply, cable TV access, Internet access, education/knowledge, etc. These three entity types are mutually connected by relationships

of M:N cardinalities, all three having corresponding primary keys and a number of non-key attributes that entirely describe the interaction among them.

In Figure 1, each instance of the entity type PRODUCT belongs to a single subcategory (entity type SUBCATEGORY), which is further being categorized into a single category (entity type CATEGORY). Therefore, the relationships *BELONGS\_TO* and *SUBCATEGORY\_OF* are both of a cardinality M:1. For instance, the product ‘Bread’ (an instance of the entity type PRODUCT) belongs to a single (1) subcategory ‘Bread and bakery’, which is just a single (1) subcategory of the category ‘Food’. The latter one includes many (M) other subcategories, e.g. ‘Fruits’, ‘Vegetables’, ‘Cereal and cereal products’, ‘Dairy products and analogs’, ‘Meat and meat products’, ‘Fish and fish products’, etc. [5]. Likewise, each subcategory may include many (M) products.

Before transforming the E-R diagram into a graph database model, it is convenient to point out the process of transformation, which can be carried out through a number of steps [6-10]:

- Each entity table is represented by a label on nodes;
- Each row in an entity table (i.e. instance) becomes a particular node;
- Columns on those tables (entity table’s attributes) become node properties;
- Technical primary keys should be removed, whilst keeping business ones;
- Unique constraints should be added for business primary keys;
- Indexes should be added for frequent lookup attributes;
- Each foreign key that appears in entity tables (M) due to the existence of a relationship with a 1:M cardinality, should be replaced with a relationship to the other table (1) in the corresponding graph data model, and removed afterward from the original (originating) table/entity type;
- Data with default values should be removed, there is no need to store those;
- Data in tables that are de-normalized and duplicated might have to be pulled out into separate nodes to get a cleaner model;
- Indexed column names might indicate an array property;
- Simple JOIN tables that come out from the M:N relationships in the E-R diagram become simple relationships in the graph data model;
- Attributed JOIN tables that come out from the M:N relationships in the E-R diagram become relationships with properties in the graph data model.

The resulting graph database model, which is semantically equivalent to the E-R diagram depicted in Figure 1, is given in Figure 2.

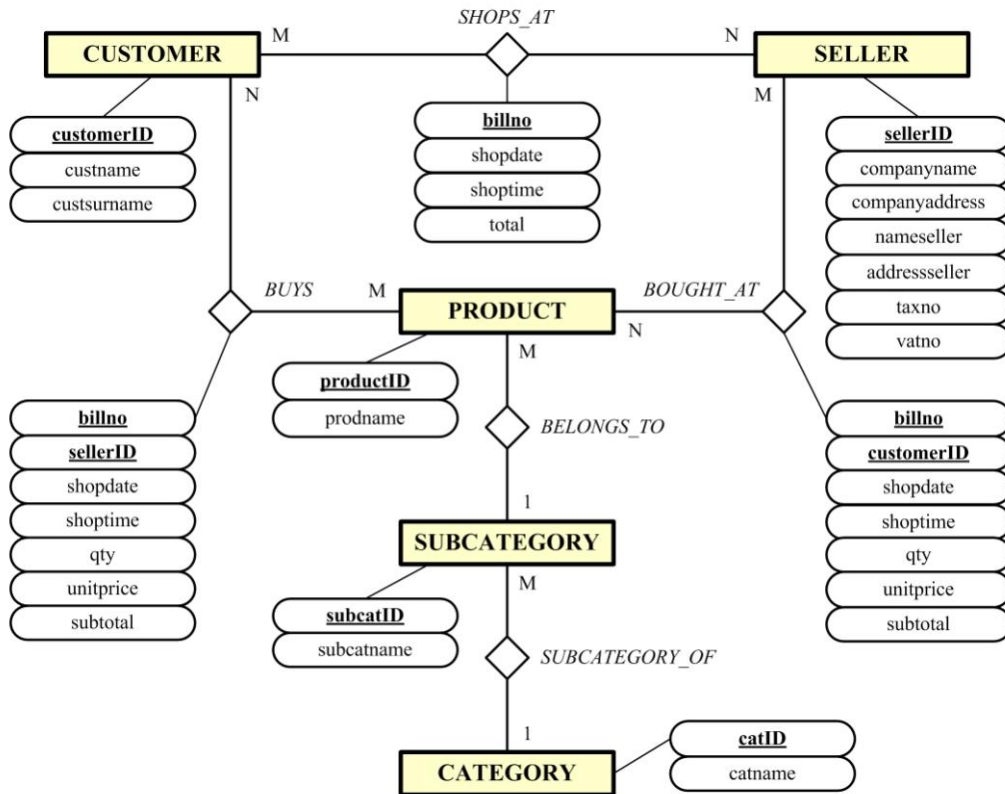

Figure 1. E-R diagram depicting the entities, their attributes, and relationships needed to model financial transactions and the consumer spending behavior

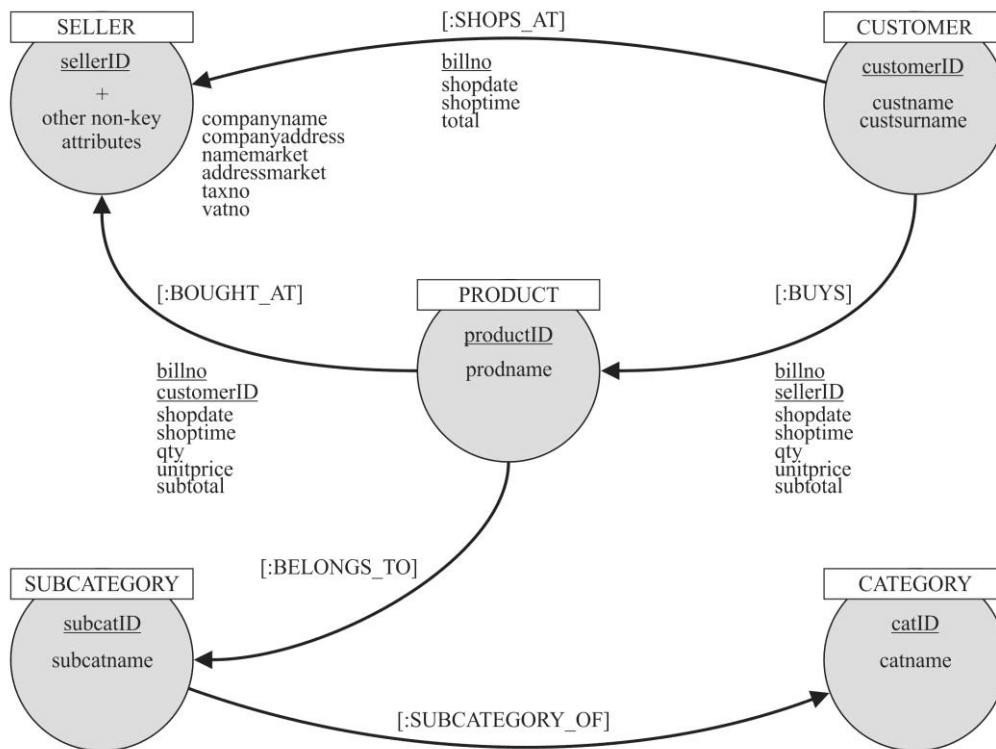

Figure 2. The equivalent graph database model

### III. SOME BASIC ANALYSES RELATED TO CONSUMER SPENDING BEHAVIOR

The graph database model, shown in Figure 2, is suitable for performing a number of analyses of the consumer spending behavior. In order to make evidence for some of them, we have set up a test graph database in Neo4j. It consists of two nodes labeled 'CUSTOMER' that correspond to two adult members of a hypothetical family. During a given period of time, they are spending their money in different ways, e.g. by shopping at local markets and supermarkets while buying food, household products, and clothing, or by conducting a preventive maintenance of their car, by paying bills for electric power

supply, water supply, cable TV, Internet access, heating, etc. An excerpt from the test graph database, which corresponds to *customerID* = 1, is obtained by running the following CQL query and is being visualized in Figure 3.

```
MATCH (c:customer {customerID:1}),
      (p:product), (s:subcategory),
      (t:category), (r:seller)
RETURN (c)-[:BUYS]->(p)-
       [:BELONGS_TO]->(s)-
       [:SUBCATEGORY_OF]->(t), (p)-
       [:BOUGHT_AT {customerID:1}]->(r),
       (c)-[:SHOPS_AT {customerID:1}]->(r)
```

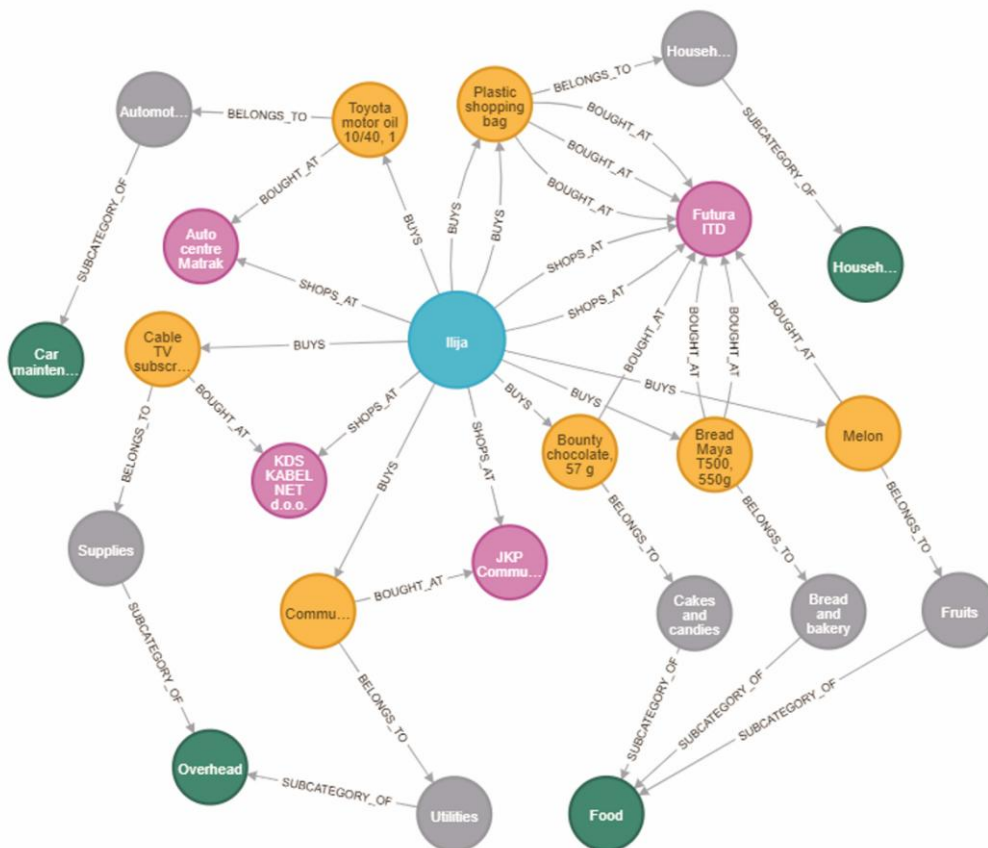

Figure 3. The outlook of the test Neo4j graph database for *CustomerID* = 1. Each particular financial transaction made by customers follows the structure and includes the constructs, of the graph database model shown in Figure 2

The so-called *sellers' vector of a particular customer* is, simply, a set of all sellers/merchants a particular customer is buying from during a given period of time. Given the test graph database, it can be obtained by running the following CQL query, which refers to *CustomerID* = 1 and the time period from August 01 to August 31, 2019:

```
MATCH (n:customer {customerID:1})-
      [s:SHOPS_AT]->(r:seller) WHERE
      s.shopdate >= "01.08.2019" AND
      s.shopdate <= "31.08.2019"
RETURN n, r
```

The seller's vector of *CustomerID* = 1 is visually depicted by Figure 4a and the one that refers to *CustomerID* = 2 by Figure 4b.

Instead visually, quantitative information can be obtained by using aggregate functions *COUNT(\*)* and *SUM(.)*, which count the number of shopping occasions with the sellers and sum the total amount paid, respectively (Figure 5):

```
MATCH (n:customer {customerID:1})-
      [r:SHOPS_AT]->(m:seller) WHERE
      r.shopdate >= "01.08.2019" AND
      r.shopdate <= "31.08.2019" RETURN
COUNT(*), SUM(r.total)
```

Other aggregate functions, like *MIN(.)*, *MAX(.)*, and *AVG(.)*, which are used for computing the minimum, maximum, and average values, respectively, can be also used, as needed, in order to obtain more profound statistical insights.

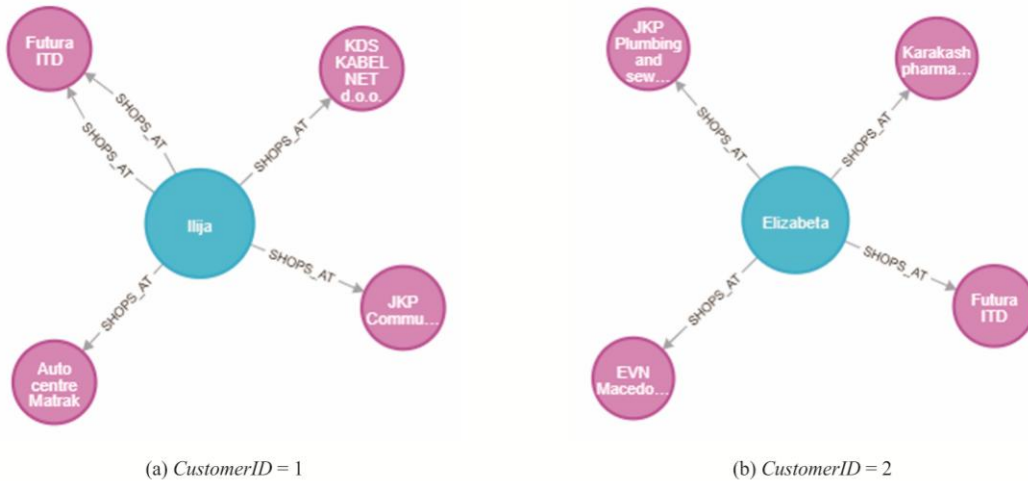

Figure 4. Sellers' vectors for two members belonging to the same family, *CustomerID* = 1 and *CustomerID* = 2, during a given period of time, represented visually

COUNT(*)	SUM(r.total)	COUNT(*)	SUM(r.total)
5	5183.0	4	2819.0

(a) *CustomerID* = 1

(b) *CustomerID* = 2

Figure 5. Sellers' vector for two members belonging to the same family, *CustomerID* = 1 and *CustomerID* = 2, during a given period of time, represented through aggregated numbers

The so-called *consumer's spending pattern model* includes information about (particular/all) consumers, (particular/all) products they bought, as well as (particular/all) subcategories and categories those products belong to. For instance, the consumer's spending pattern model for the whole household for the category 'Food', represented in Figure 6, can be obtained by running the following CQL code:

```
MATCH (c:customer), (p:product),
(s:subcategory), (t:category),
(c)-[b:BUYS]->(p) WHERE t.catname =
"Food" AND b.shoptime>="01.08.2019"
AND b.shoptime<="31.08.2019" RETURN
(c)-[:BUYS]->(p)-[:BELONGS_TO]->
(s)-[:SUBCATEGORY_OF]->(t)
```

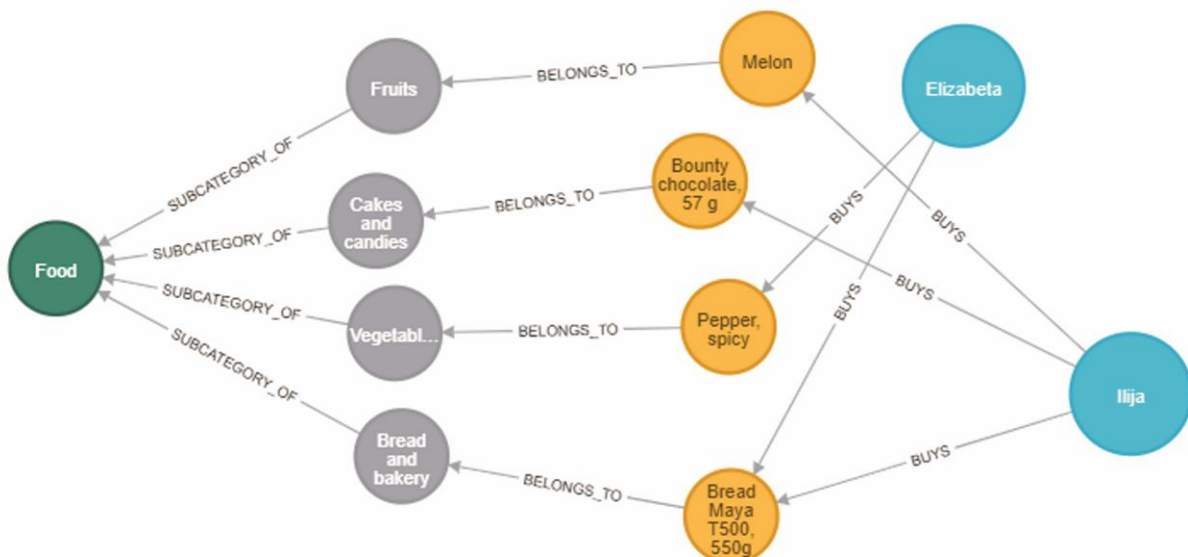

Figure 6. Consumer's spending pattern model for the whole household, for the category 'Food', during a given period of time, represented visually

The *total amount spent on a specific category* (e.g. 'Food') during August 2019, shown in Figure 7, can be calculated by running the following CQL code:

```
MATCH (c:customer)-[b:BUYS]
->(p:product)-[:BELONGS_TO]
->(s:subcategory)-[:SUBCATEGORY_OF]
->(t:category) WHERE t.catname =
"Food" AND b.shopdate >=
"01.08.2019" AND b.shopdate <=
"31.08.2019" RETURN SUM(b.subtotal)
```

SUM(b.subtotal)
214.25

Figure 7. Consumer's spending pattern model for the whole household, for the category 'Food', during a given period of time, represented through an aggregated number

The consumer's spending pattern model can be limited to a particular subcategory, as well. For instance, the consumer's spending pattern model for the whole household during August 2019, for the subcategory 'Bread and bakery', which is visually depicted in Figure 8, can be obtained by running the following CQL code:

```
MATCH (c:customer), (p:product),
(s:subcategory {subcatname:"Bread
and bakery"}), (c)-[b:BUYS]->(p)-
[:BELONGS_TO]->(s) WHERE
b.shoptime>="01.08.2019" AND
b.shoptime<="31.08.2019"
RETURN c, p, s
```

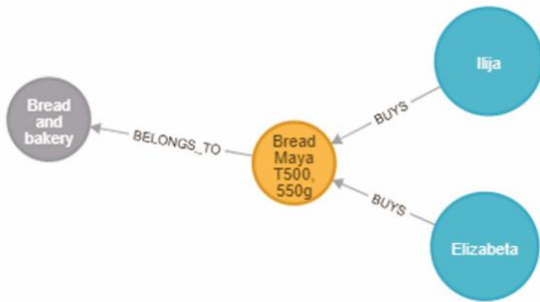

Figure 8. Consumer's spending pattern model for the whole household, for the subcategory 'Bread and bakery', during a given period of time, represented visually

The following CQL code calculates the *total amounts spent by the family members on different subcategories* during August 2019 (Figure 9):

```
MATCH (c:customer), (p:product),
(s:subcategory), (c)-[b:BUYS]->(p)-
[:BELONGS_TO]->(s) WHERE
b.shoptime>="01.08.2019" AND
b.shoptime<="31.08.2019" RETURN
s.subcatname, SUM(b.subtotal)
```

Similarly to the sellers' vector, the *consumers' vector of a particular seller/merchant* shows visually the set of all shopping occasions including the members of a given

family who shop at that particular seller/merchant (e.g. 'Futura ITD d.o.o.') during a given period of time (e.g. August 2019), depicted in Figure 10, which can be visualized by running the following CQL query:

```
MATCH (c:customer), (s:seller),
(c)-[r:SHOPS_AT]->(s) WHERE
s.companyname="Futura ITD d.o.o."
AND r.shopdate>="01.08.2019" AND
r.shopdate<="31.08.2019"
RETURN c, s
```

s.subcatname	SUM(b.subtotal)
"Households for common use"	3.0
"Fruits"	63.25
"Automotive parts and accessories"	3600.0
"Bread and bakery"	75.0
"Cakes and candies"	29.0
"Vegetables"	47.0
"Prescription only medicines"	83.0
"Supplies"	2341.0

Figure 9. Consumer's spending pattern model for the whole household, by different (all) subcategories of products, during a given period of time, represented through aggregated numbers

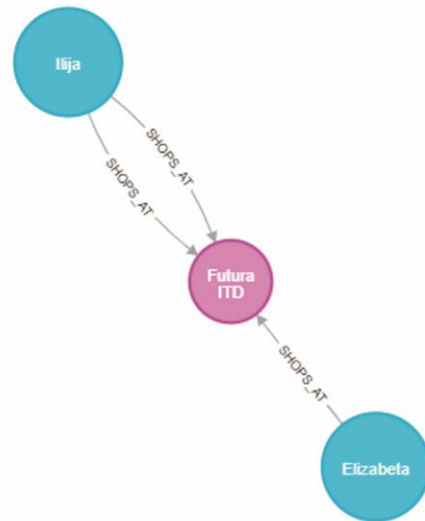

Figure 10. Consumer's vector of a particular seller ('Futura ITD d.o.o.') for the whole household, during a given period of time, represented visually

The following CQL code calculates the total amounts spent by the family members with a particular seller during a specified period of time (Figure 11):

```
MATCH (c:customer), (s:seller),
(c)-[r:SHOPS_AT]->(s) WHERE
s.companyname="Futura ITD d.o.o."
AND r.shopdate>="01.08.2019" AND
r.shopdate<="31.08.2019"
RETURN c.customerID, c.custname,
SUM(r.total) ORDER BY c.customerID
```

c.customerID	c.custname	SUM(r.total)
1	"Ilija"	119.0
2	"Elizabeta"	98.0

Figure 11. Consumer's vector of a particular seller ('Futura ITD d.o.o.') for the whole household, during a given period of time, represented through aggregated numbers

Finally, the following CQL code provides an insight into the *set of products that are bought by the family members at a particular seller/merchant* (e.g. 'Futura ITD d.o.o.'), visually presented in Figure 12, during a specified period of time (e.g. August 2019):

```
MATCH (p:product), (s:seller),
(p)-[r:BOUGHT_AT]->(s) WHERE
s.companyname="Futura ITD d.o.o."
AND r.shopdate>="01.08.2019" AND
r.shopdate<="31.08.2019"
RETURN p, s
```

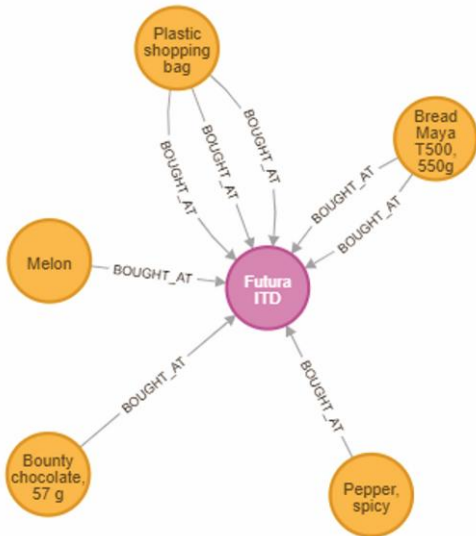

Figure 12. Set of products bought by the family members at a particular seller/merchant ('Futura ITD d.o.o.'), during a given period of time, represented visually

Based on the previous CQL query, the *total amount spent on products bought at a particular seller* during a specified period of time can be calculated by the following CQL code:

```
MATCH (p:product), (s:seller),
(p)-[r:BOUGHT_AT]->(s) WHERE
s.companyname="Futura ITD d.o.o."
AND r.shopdate>="01.08.2019" AND
r.shopdate<="31.08.2019"
RETURN ROUND(SUM(r.subtotal))
```

The execution of the above CQL code generates an output as shown in Figure 13. It should be notified that it is completely equivalent to the one presented in Figure 11.

All of the previously presented CQL examples can be easily modified in order to answer additional queries *vis-à-vis* the consumer's spending behavior.

ROUND(SUM(r.subtotal))
217.0

Figure 13. Total amount spent on products bought by the family members at a particular seller during a specified period of time represented through an aggregated number

#### IV. CONCLUSION

Graph databases address the shortcomings of relational databases for modeling and querying complex relationships because they treat relationships as separate objects to achieve superb performances and increase the readability of the model. They can help generate valuable insights from the existing data, especially in cases where relationships between data points matter more than the individual points themselves. This is a consequence of the fact that with graph databases, relationship information is treated as a 'first-class citizen'.

When it comes to modeling consumer spending behavior, the Neo4j graph database, along with the Cypher query language, provides an indispensable tool for conducting a myriad of analyses on specific graph subsets that reveal valuable insights, both visual and quantitative. If applied on a higher level, e.g. country level, such analyses can give an answer to highly important questions that can speak a lot where the national economy may be heading to, such as:

- What is the share of different expenditure categories (e.g. Food, Transportation, Personal care, Health care, Apparel, Entertainment, Housing-related expenditures, etc.) in the overall consumer expenditure?
- Are consumers spending less or more of their incomes on traditional retail items such as Apparel and Groceries?
- Just how have consumer spending patterns changed over time?
- What are the residents of a particular country doing with their growing incomes?

Answering these can significantly help policy-makers in making better decisions.

*Apropos* the proposed graph data model, it has the following features:

- It has a relatively simple, yet semantically rich structure, comprised of five categories of nodes and five categories of relationships;
- Despite its simple structure, the proposed graph data model allows one to perform myriad of CQL queries to obtain a profound understanding of the consumers' spending patterns;
- The proposed graph database model can be easily enriched by including additional constructs (i.e. nodes and/or relationships) to meet other, more sophisticated analyses' requirements, as needed.

REFERENCES

- [1] H. Kileo, "Importance of Financial Management", LinkedIn.com, 2016. [Online]. Available: <https://www.linkedin.com/pulse/importance-financial-management-hamza-kileo/>. [Accessed 26-Jun-2019].
- [2] S. Shah, "Chapter 2: Importance of Financial Management", WikiFinancepedia.com, 2019. [Online]. Available: <https://wikifinancepedia.com/finance/financial-management/top10-importance-of-financial-management>. [Accessed: 26- Jun- 2019].
- [3] W. Kenton, "What is Consumer Spending?", Investopedia, 2018. [Online]. Available: <https://www.investopedia.com/terms/c/consumer-spending.asp>. [Accessed: 26- Jun- 2019].
- [4] I. Robinson, J. Webber, and E. Eifrem, Graph Databases: New Opportunities for Connected Data. 2nd ed., Sebastopol, CA, USA: O'Reilly, 2015.
- [5] FAO & WHO, "GSFA Online Food Categories", Fao.org, 2019. [Online]. Available: <http://www.fao.org/gsfonline/foods/index.html?collapse=53>. [Accessed: 07- Aug- 2019].
- [6] M. Hunger, R. Boyd, and W. Lyon, "Ebook: The Definitive Guide to Graph Databases for the RDBMS Developer". Neo4j Graph Database Platform, 2016. [Online]. Available: <https://neo4j.com/whitepapers/rdbms-developers-graph-databases-ebook/>. [Accessed: 10- Aug- 2019].
- [7] M. Hunger, "From Relational to Graph: A Developer's Guide". DZone.com, 2016. [Online]. Available: <https://dzone.com/storage/assets/2054302-dzone-refcardz-231-neo4j.pdf>. [Accessed: 11- Aug- 2019].
- [8] S. Yang, "How to Map Relational Data to a Graph DB in Four Steps". Tibco.com, 2018. [Online]. Available: <https://www.tibco.com/sites/tibco/files/resources/sb-graph-database-final.pdf>. [Accessed: 11- Aug- 2019]
- [9] Neo4j, "Model: Relational to Graph", Neo4j Graph Database Platform, 2019. [Online]. Available: <https://neo4j.com/developer/relational-to-graph-modeling/>. [Accessed 12- Aug- 2019]
- [10] M. Hunger, R. Boyd, and W. Lyon, "RDBMS & Graphs: Relational vs. Graph Data Modeling", Neo4j Graph Database Platform, 2016. [Online]. Available: <https://neo4j.com/blog/rdbms-vs-graph-data-modeling/>. [Accessed: 13- Aug- 2019].

# Fake News Detection in Social Media: A Survey

A. Shijakova\* and Z. Kotevski\*\*

\*Voice of America, Washington DC, United States of America  
“St. Kliment Ohridski” University – Bitola, Faculty of Information and Communication Technologies,  
Bitola, North Macedonia  
AShijakova@voanews.com, zoran.kotevski@fikt.edu.mk

**Abstract – Contemporary communication technologies have revolutionized the way in which information is disseminated in the world, allowing unverified sources to generate “news” and influence the public opinion quite a bit. In recent years, reliability of information on the Internet has become a crucial issue of modern society, especially the content generated in social media. Fake news are even considered to have extremely negative effects on individuals and have a significant real-world political and social impacts. Because of the amount of disseminated information via social media, it is practically impossible to discern true from fake news. Thus, the possibilities for automated detection of fake news on social media has recently become an emerging research that is attracting tremendous attention. Since the issue of fake news detection in social media can be characterized as both challenging and relevant, in this paper we present a survey of the latest research covering this important scientific field. We discuss the accomplishments of related research and their detection approaches and we conclude the paper with future expectations in automated fake news detection.**

## I. INTRODUCTION

“Fake news” is a relatively new term, but old phenomenon connected with false, inaccurate information. Prior to the emergence of rapid modes of communication and verification opportunities, in the 17th century, at the end of the text of unconfirmed news, some English newspapers added the “n.t.” mark according to the Latin expression “Non Testatum”, or in English “Not Testified”, which meant that the source was not confirmed. The term “duck” was also long time connected with fake news. The “n.t.” mark in Germany, according to the rules of the German language, was read as “ente”, while “Die Ente” in German means duck. Yellow journalism and the yellow press are American terms for little or no legitimate well-researched news, with eye-catching headlines. Main characteristics of this kind of news are sensational, unprofessional and unethical information aimed mainly towards bigger sales. Through the history, every technological advancement, from the telegraph in the 19th century to contemporary social media systems in present times, opens a new possibilities for news fabrication [1].

“Fake news” can also be defined as news articles that are intentionally and verifiably false, and could mislead readers [2]. This definition includes intentionally fabricated news articles. According to the definition made

by PolitiFact [3] fake news is made-up stuff, masterfully manipulated to look like credible journalistic reports that are easily spread online to large audiences willing to believe the fictions and spread the word.

The purpose of news is to provide the citizens with information they need to make the best possible decisions about their lives, their communities and their societies. Without accurate news citizens cannot make right decisions. Made-up news designed to mislead cause a great deal of confusion about the basic facts of current issues. Hence, false news inflicts multiple layers of damage on the all levels of society.

In modern time “Fake news” phenomenon received special attention since the win of Donald Trump in the U.S. presidential elections of 2016. The problem became even more serious when it was difficult to maintain control over the fake news that spread rapidly through social media. In the battle for click-baits content consumers were attracted virally to spread the false information or hoax news, mainly through social media. Getting news from the social media is easy, fast and inexpensive compared to traditional news media. But, on the other side, that is the main reasons for wide and extensive spreading of fake news through social media. Research shows that the quality of news on social media is lower than on traditional news organizations. Purposes for producing fake news vary from case to case and from financial to political aims.

There is a growing number of adults in the United States who follow news through the social media. In 2016, 62% followed the news on social media, while in 2012 only 49%. Most of them get the news on Reddit, Facebook and Twitter [4]. They are exposed on fake news risks every day. Therefore, fake news detection on social media is a primary step in the fight against fake news. According to the Pew Research Center survey [5] conducted between Feb. 19 and March 4, 2019, more Americans (50%) view made-up news as a very big problem for the country than identify violent crime (49%), climate change (46%), racism (40%), illegal immigration (38%), terrorism (34%) and sexism (26%).

Contrary to the historical prevention of fake news like the aforementioned “n.t.” marking, today’s societies are quite used to receiving news via user generated content, such as social media, where the control of the news source



is impossible. According to Brandwatch [6], there are nearly 2.5 billion Facebook users in the world that generate about four petabytes of data every day and 45% of them get the news from Facebook. This is only one of the most popular social networks, but if we include others like Twitter, YouTube, Instagram, LinkedIn etc. it seems that everyone is getting some news from social media. The problem that arises from this vast amount of user generated information is that people cannot distinguish between fake and real news, at least not for a certain amount of time that may be sufficient to fulfill the intended goal. In such situation, where no established source of news exist and where it is extremely hard to discern real from fake news, the only way to detect fake news is by the deployment of contemporary technologies. Fake news detection has gained quite a lot of attention in recent years, especially regarding information disseminated via social media. This research presents a survey of the latest research efforts in the field of fake news detection in social media, discusses their strengths and weaknesses and proposes future research directions.

The rest of the paper is organized as follows. In section 2 we present the latest research in the development of approaches and techniques for fake news detection. Section 3 discusses the performance of the most promising fake news detection approaches, while in section 4 we conclude the paper with summary of contribution and directions for future development of algorithms for fake news detection.

## II. RELATED RESEARCH

Kai Shu et al. [7] analyze existing algorithms for detection of fake news in social media from a data mining perspective. They explore collection of contradicting sources that record the properties of objects. More specifically, they outline their research categorizing the existing methods based on their main input sources as News Content Models and Social Context Models. News Content Models mainly rely on news content features and existing news sources where the information whether fake or real is determined by comparison techniques. Social Context Models, besides news information, include relevant user social engagements to determine the veracity of the news. Determination of the source credibility and object truthfulness is the main aim of this truth discovery method. But, the obstacle to applying this method is when a fake news article is just launched and published by only a few news outlets, because at that point there are not enough social media posts that could be used as additional sources for truth detection. The authors elaborate the performance of these methods and also propose a future research directions in automated fake news detection.

Eugenio Tacchini et al. [8] present quite interesting and novel technique for detection of fake news in social media by analyzing the users' "likes". For this purpose they present two classification techniques, one based on logistic regression and the other based on an adoption of Boolean crowdsourcing algorithms. The main contribution of this research is the achieved accuracy of both techniques of above 90% where adopted Boolean Crowdsourcing achieves accuracy above 99%.

William Yang Wang [9] presents new dataset for fake news detection „LIAR“, that is publicly available. Surface-level linguistic patterns are in the focus of this empirical model for automatic fake news detection. The author has designed a novel, hybrid convolutional neural network to integrate metadata with text, showing that this hybrid approach can improve a text-only deep learning model. This dataset rely on a large number of short statements (in a categories: news releases, TV/radio interviews, campaign speeches, TV ads, tweets, debates, Facebook posts, etc.) labeled for truthfulness, subject, speaker, state, party, context, venue, and prior history. In the process of fake news detection the labeler analyzes each judgment, providing the links to supporting documents. This research points out that main application of this dataset is to facilitate the development of machine learning models for automatic fake news detection.

Sebastian Tschatschek et al. [10] introduce algorithmic tools through learning about users. Fake news detection is made via expert's verification of the flagging activity of users. This method relies on a Facebook tool that enable users to flag misleading news. Through aggregating users' flags, a small subset of news, which potentially is fake, is selected every day for expert analysis. They develop a novel algorithm, Detective, that performs Bayesian inference for detecting fake news and jointly learns about users' flagging accuracy. When expert labels the news as fake, that news could be blocked on the network or marked as disputed with aim to minimize the spread of misinformation making it appear lower in news-feed ranking.

According to Niall Conroy et al. [11] linguistic approaches with machine learning and network-based approaches together could significantly improve fake news detection process within limited domains. They suggest use of these approaches together for designing a hybrid fake news detection system that will improve, but not replace human judgement.

Veronica Pérez-Rosas et al. [12] contributed to the area of fake news detection by machine learning models using R language. Their models use a combination of lexical, syntactic and semantic information, as well as features representing text readability properties. For their experimental evaluations they also introduce two novel datasets that cover seven different news domains. The results obtained exhibit detection accuracy ranging from 50% to 91%, which is quite above the average of random guessing of 50%, but not sufficient to surpass the human ability to spot fake content.

Natali Ruchansky et al. [13] present rather complex model for fake news detection in social media based on neural networks. Their model takes into account both articles and users and they also incorporate group behavior of users who propagate fake news. Their experiments are conveyed using TWITTER and WEIBO datasets that provide real world scenarios. The authors reveal encouraging results, but emphasize that automatic fake news detection remains a challenging problem with many open questions.

Feyza Altunbey Ozbay and Bilal Alatas [14] consider fake news detection on social media as an optimization

problem. Two metaheuristic algorithms, the Grey Wolf Optimization (GWO) and Salp Swarm Optimization (SSO) have been adapted in the process of fake news detection, that consist of three stages: data processing, adapting GWO and SSO for construction of a novel fake news detection model and testing on real-world datasets. The results are compared with seven supervised artificial intelligence algorithms and the best accuracy is obtained from GWO within all datasets. One of the conclusions is that the use of adaptive and hybrid versions of the algorithms may improve the results.

Martin Potthast et al. [15] take a meta-learning approach known as Unmasking, originally intended for authorship verification, to analyze the writing style of hyperpartisan (i.e., extremely one-sided) news. This approach, based on publicly shared dataset, includes manual news fact-checking realized by professional journalists and identifying similarities between the styles of left-wing and right-wing news, i.e. two with significant stylistic similarities. They share a common style of extremism and claim that humor in the news articles can be distinguished well from other news. They point out that style analysis alone is not enough, but can help in the fake news detection process.

Yang Liu and Yi-Fang Brook Wu [16] propose classifying news propagation paths model for early detection of fake news on social media. In the fake news detection process, recurrent and convolutional networks are applied for identifying both global and local variations of user characteristics along propagation paths. Experimental results on three real-world datasets demonstrate that this model has high accuracy in the fake news detection of 85% on Twitter and 92% on Sina Weibo, within 5 minutes after fake news starts to spread, which is significantly faster than state-of-the-art baselines.

Julio CS Reis et al. [17] worked on several types of features extracted from news stories that can be used to discriminate true and fake news. Fully labeled dataset is used for testing of the effectiveness of a variety of supervised learning classifiers. They point out that mix of true and false facts may mislead readers. From this point, source and posts from social media, language processing techniques, reliability and environment (e.g., social network structure), are in the focus of their analyses.

### III. FAKE NEWS DETECTION APPROACHES: PERFORMANCE AND REQUIREMENTS

The advantage of automatic fake news detection is the speed of detection of misleading news, which is crucial to prevent them to spread through social networks and reach larger audiences. But, the automatic detection efficiency is high when the fake news detection process is based on a datasets that provide a well prepared quality information connected with the topic of potential fake news. Without relevant datasets, level of efficiency of the automatic fake news detection process is lower. This highlights the importance of using adequate datasets as a base for development of automatic fake news detection techniques. Experiences reveal that no existing public dataset can provide all possible features of interest. Each dataset is unique and does not have all the characteristic of any other

dataset. It means some of them (for example BuzzFeedNews) contains headlines and text of news articles, other (such as LIAR) mostly contain only short statements collected from various speakers, rather than news publishers, and may include some claims that are not fake news. In order to overcome such weaknesses there is an ongoing project to develop a usable dataset for fake news detection on social media, called FakeNewsNet20 that should include all needed news content and social context features with reliable ground truth fake news labels [7].

One of the promising automatic fake news detection methods is crowdsourcing-oriented fact-checking approach, based on the “wisdom of the crowd“, which provides an opportunity to users to discuss and annotate the accuracy of the news content. For example, there is a Facebook tool that enables users to flag misleading news. Through aggregating users’ flags, a small subset of news, which potentially is fake, is selected every day for expert analyses. The other similar technique for detection of fake news in social media is analyzing the users’ “likes“. If we analyze these techniques in the light of the media literacy it means that from the level of media literacy of the public depends how many articles will be identified/flagged as potentially fake news. This indicates that media literacy is an important prerequisite for successful detection of fake news. If no reader reports that something is wrong with certain news article, then the process of checking that news article will not even begin.

Media literacy is defined as a capacity to access, analyze and critically assess and create new media contents. At the same time it has three dimensions: technical competencies, practical skills for critical thinking and producing contents. From the media literacy, by which technical, critical and practical skills are developed, it depends how much the individual will have a formed critical thought to distinct facts from propaganda. These facts one more time confirm that human factor cannot be left out of fake news detection process.

Part of the fight against the fake news is using algorithms to fight algorithms, since algorithms are part of what spreads the fake news, so now they are also part of the solution by identifying fake content and validating the information sources. But, they still lack the necessary robustness to perform a reliable verification of which information is false or not [18]. The use of adaptive and hybrid versions of the algorithms may improve the results.

The hostile media phenomenon can negatively affect the automatic fake news detection. Some of the users who already have an opinion on a given subject can interpret the same content (regarding that subject) in different ways. Because of that, this user can classify that news article as fake news, even if it is not. Deep learning approaches and some machine learning algorithms are black-box systems that, given an input (in this case, a social media post), they output a score or a label (in this case a credibility score or a fake/true label). This emphasizes the need for expert fact-checking, which also points to the importance of the human factor in

overcoming the deficiencies of automatic detection of fake news.

Considering that different techniques have their advantages and disadvantages, additional screening researches are needed towards solution that combines all the strengths and outweighs all the weaknesses in order to achieve the greatest possible efficiency in the fake news detection process. A new fake news detection model is needed in which automation, fact-checking on an expert level and the public as a participant in the process will be combined.

#### IV. CONCLUSION

Even though fake news detection is a relatively new paradigm, the interest for research that propose novel techniques for automated detection of fake news grows with a rapid pace, in parallel with the seriousness of the problem. Existing techniques are constantly improved, while new ones are tested and implemented. The main emphasis on this development trend is the early detection of false news, quite soon after publication, in order to prevent their dissemination to a larger number of recipients.

Because of this “race” to quickly detect and prevent fake news, contemporary technologies such as Artificial Intelligence, Big Data analyses, Machine Learning and Neural Networks are commonly employed. Nevertheless, the automated techniques accelerate the fake news detection problem, but cannot replace the human factor completely. The experiences gained from the latest research in this field reveal that for full functionality of a fake news detection process, detected potential fake news should be sent to specialized experts for fact-checking. This is because the basic nature of the problem does not allow complete automation, but rather necessitates human involvement to a certain extent. On the other hand, research on the impact of human fact-checking is relatively recent but the existing research suggests that fact-checking does indeed correct misperceptions among citizens, as well as discourage politicians from spreading misinformation.

Additionally, to increase the efficiency of fact-checking it is necessary to be conducted by professionals, journalists, political analysts or other associated experts who are quite familiar with societal, political and other related areas in the environment concerned.

#### REFERENCES

- [1] Gelfert, Axel. “Fake news: A definition.” *Informal Logic* 38, no. 1 (2018): 84-117.
- [2] Allcott, Hunt, and Matthew Gentzkow. “Social media and fake news in the 2016 election.” *Journal of economic perspectives* 31, no. 2 (2017): 211-236.
- [3] PolitiFact Project (<https://www.politifact.com/>).
- [4] Pew Research Center (<https://www.pewresearch.org/>), “News Use Across Social Media Platforms 2016”, May 2016.
- [5] Pew Research Center (<https://www.pewresearch.org/>), “Many Americans Say Made-Up News Is a Critical Problem That Needs To Be Fixed”, June 2019.
- [6] Brandwath (<https://www.brandwatch.com/>), “53 Incredible Facebook Statistics and Facts”, June 2019.
- [7] Shu, Kai, Amy Sliva, Suhang Wang, Jiliang Tang, and Huan Liu. “Fake news detection on social media: A data mining perspective.” *ACM SIGKDD Explorations Newsletter* 19, no. 1 (2017): 22-36.
- [8] Tacchini, Eugenio, Gabriele Ballarin, Marco L. Della Vedova, Stefano Moret, and Luca de Alfaro. “Some like it hoax: Automated fake news detection in social networks.” *arXiv preprint arXiv:1704.07506* (2017).
- [9] Wang, William Yang. “Liar, liar pants on fire: A new benchmark dataset for fake news detection.” *arXiv preprint arXiv:1705.00648* (2017).
- [10] Tschiatschek, Sebastian, Adish Singla, Manuel Gomez Rodriguez, Arpit Merchant, and Andreas Krause. “Fake news detection in social networks via crowd signals.” In *Companion Proceedings of the The Web Conference 2018*, pp. 517-524. International World Wide Web Conferences Steering Committee, 2018.
- [11] Conroy, Niall J., Victoria L. Rubin, and Yimin Chen. “Automatic deception detection: Methods for finding fake news.” *Proceedings of the Association for Information Science and Technology* 52, no. 1 (2015): 1-4.
- [12] Pérez-Rosas, Verónica, Bennett Kleinberg, Alexandra Lefevre, and Rada Mihalcea. “Automatic detection of fake news.” *arXiv preprint arXiv:1708.07104* (2017).
- [13] Ruchansky, Natali, Sungyong Seo, and Yan Liu. “Csi: A hybrid deep model for fake news detection.” In *Proceedings of the 2017 ACM on Conference on Information and Knowledge Management*, pp. 797-806. ACM, 2017.
- [14] Ozbay, Feyza Altunbey, and Bilal Alatas. “A Novel Approach for Detection of Fake News on Social Media Using Metaheuristic Optimization Algorithms.” *Elektronika ir Elektrotechnika* 25, no. 4 (2019): 62-67.
- [15] Potthast, Martin, Johannes Kiesel, Kevin Reinartz, Janek Bevendorff, and Benno Stein. “A stylometric inquiry into hyperpartisan and fake news.” *arXiv preprint arXiv:1702.05638* (2017).
- [16] Liu, Yang, and Yi-Fang Brook Wu. “Early detection of fake news on social media through propagation path classification with recurrent and convolutional networks.” In *Thirty-Second AAAI Conference on Artificial Intelligence*. 2018.
- [17] Reis, Julio CS, André Correia, Fabrício Murai, Adriano Veloso, Fabrício Benevenuto, and Erik Cambria. “Supervised Learning for Fake News Detection.” *IEEE Intelligent Systems* 34, no. 2 (2019): 76-81.
- [18] Figueira, Álvaro, and Luciana Oliveira. “The current state of fake news: challenges and opportunities.” *Procedia Computer Science* 121 (2017): 817-825.

# Next Generation Networks (5G Technology) - Performance Analysis

K. Veljanovska\* and M. Filiposka\*\*

\* Department of Intelligent Systems, Faculty of Information and Communication Technologies, University "St. Kliment Ohridski", Bitola, Republic of North Macedonia

\*\* "St. Kliment Ohridski" University, Faculty of Information and Communication Technologies  
Bitola, Republic of North Macedonia  
kostandina.veljanovska@fikt.edu.mk

**Abstract** – The coming fifth – generation wireless broadband technology known as 5G is expected to provide bigger speeds, better coverage, and higher quality of service and reliability than the existing 4G. It will connect billion of devices, enabling the subscribers to share their data at any time and any place. This paper summarizes the benefits of the next generation technology and possibilities of implementing it in our Country. In order to support the new technologies, several waveforms are proposed, among which, the most competitive ones are OFDM (Orthogonal Frequency Division Multiplexing) and FBMC (Filter Bank Multi Carrier Modulation). As part of this research, using MATLAB simulation software, we have done comparative analysis of these two waveforms based on their Power Spectral Densities (PSD) and magnitude responses of their prototype filter. Discussion and analysis of the results are given in the paper.

**Keywords**- 5G technology, OFDM, FBMC, Power Spectral Density (PSD), PHYDYAS (PHYSical layer for DYnamic spectrum AccesS and cognitive radio)

## I. INTRODUCTION

The next generation of wireless technology is 5G. It is expected to be the one of the fastest and most robust technologies ever seen. The technology will provide a new frequency bands and wider spectral bandwidth. The combination of higher speed, quick response and quality of experience (QoE) would be able to uncover many potentialities with other future trends such as autonomous cars, drones, virtual reality and IoT (Internet of Things).

There are many differences between the next generation networks and previous generations, such as [1]:

- Increased battery life;
- 5 times lower delay and high reliability;
- High spectral efficiency;
- High resolution and bandwidth;
- A larger number of connected devices;
- 1000 times higher mobile data volumes;
- Consistent and flexible connectivity;
- Lower cost of infrastructural development

## II. NEXT GENERATION NETWORKS ARCHITECTURE CHARACTERISTICS

The next generation networks will fulfill all of the expectations using a lot of small cell coverage and higher bandwidth spectrum. 5G will operate along with existing 4G network at the beginning, before evolving to fully standalone network.

### A. The advantages of 5G

The 5G technology is expected to change our everyday life. It will support higher speeds with quality of experience (QoE) and connect massive numbers of devices together [2]. 5G is much more than smart phones or faster Facebook opening. This generation of network will open the door to robotic surgeries, self – driving cars, safer transport networks, smart cities, virtual and augmented reality. It will enable the Internet of things (IoT) that will connect billions of devices without human intervention and it will allow better customer experience and long term growth.

5G is supposed to be 100 times faster than the existing 4G network, with speed of 10 gigabits per second (Gb/s). Faster speeds will allow more high quality data to be transferred and will improve the connectivity and reliability. ITU's International Mobile Telecommunication System (IMT) – 2020 report shows increased download speeds of 100 Mb/s minimum and a theoretical maximum of 20 Gb/s [3,4,5]. In our country, the mobile operator, Makedonski Telekom, has measured the highest download speed (above 500 Mb/s) in the region. 5G, will also dramatically reduce the delay, which means faster load times and bigger responsiveness when using the Internet. The maximum latency is expected to be 4ms on 5G compared to 20ms on 4G LTE (Long Term Evolution).

### B. 5G Architecture

The coming 5G network is IP based and uses packet switching for delivering better performance and low cost. For achieving massively higher capacity (10 times more than 4G bandwidth), a millimeter – wave (mm – Wave) will be addressed. At the beginning, 5G will be integrated with the existing 4G network architecture, in order to provide a continuous connection, low latency and bigger speed.

The network architecture of this generation has two main components: "Radio Access Network" - RAN and the "Core Network" [1]. The first part, RAN consists of small cells, known as mini base stations, designed for a very localized coverage (from 10 meters to a few hundred meters). Also, it will contain towers, in – building and home systems in order to perform connection to the core network. Macro cells will use Massive MIMO (multiple input, multiple output) antennas that have multiple connections for sending and receiving more data simultaneously. The Core Network, on the other side, manages all of the data, mobile and Internet connections. It allows better integration with the Internet and cloud based services. In 5G network architecture, all IP based mobile applications and

services are offered via Cloud Computing Resources (CCR). Cloud computing allows users to use applications without any installation and to access their personal data at any computer that has Internet access.

### III. WAVEFORMS FOR 5G COMMUNICATION SYSTEM COMPARISON

Introducing 5G will lead to revolutionary changes in terms of energy efficiency, data rate, latency, better connectivity and network reliability. The high requirements will only be met by introducing innovative technologies, different from existing ones. Until now, the most spread case of multicarrier system was the OFDM technique with cyclic prefix (CP - OFDM). It uses an orthogonal set of subcarriers which contributes to its low implementation complexity. But, its tight timing and need for synchronization are difficult to obtain in practice. [6, 7].

An FBMC, especially the offset - QAM - based filterbank multicarrier (FBMC-OQAM) waveform is obtained through the transmission of data through a filter bank, which is the main difference when compared to the existing OFDM technique. While in OFDM systems an IFFT (Inverse fast Fourier transformation) is used with Cyclic Prefixing (CP), in FBMC this is replaced by a synthesis filter bank.

These two techniques could be compared based on multiple criteria such as: their computational complexity, sub channels, prototype filter, Power Spectral Densities etc. In this case, we will use examples provided by MATLAB simulation software to make a comparative analysis based on their Power Spectral Densities (PSD) and magnitude responses of the prototype filter. MATLAB as a simulation software is well known for its wide range of tools, and also includes the 5G tool that offers different functions and examples for modeling and simulation of 5G network.

PSD describes the signal's power as a function of frequency. The system parameters are modified in order to explore their influence on the system. Before the parameters are defined, the random number generation function ("rng") is set for repetition. This function initializes the random number generator by:  $s = \text{rng}(211)$ . Other system parameters are set as:

```
numFFT=256;
numGuards=20;
K=3;
bitsPerCarrier=4;
numSymbols=1000,
```

where:  $numFFT$  is the number of FFT points;  $numGuards$  represent the empty space between two radio bands;  $K$  is an overlapping factor with values between 2, 3 or 4;  $bitsPerSubCarriers$  with values: 2: 4QAM (transfer of 3 bits per symbol), 4: 16QAM, 6: 64QAM, 8: 256QAM and  $numSymbols$  is simulation length in symbols.

#### A. FBMC Modulation

OFDM has limitations, like the need for synchronization and low spectral efficiency and FBMC offers a possibility for overcoming them by filtering every modulated signal of the subcarrier [8, 9]. FBMC - OQAM uses a pulse shape which is more spread out in time. PHYDYAS (PHYSical layer for

DYnamic spectrum AccesS and cognitive radio) prototype filter is as a result of its better localization and the simplicity of equalization of the sender and receiver. The characterization of the filter banks is overlapping factor -  $K$ , which is a number of multicarrier symbols that overlap in the time domain. There is a possibility to choose prototype filter order in this way:  $2*K-1$  where  $K = 2, 3, \text{ or } 4$ . FBMC uses an  $N*K$  length IFFT where the symbols are overlapped with a delay of  $N/2$ , where  $N$  is the number of subcarriers. The MATLAB code is used to calculate the prototype filter using switch function as follows:

```
L = numFFT - 2 * numGuards;
switch K
case 2
    HkOneSided = sqrt (2) / 2;
case 3
    HkOneSided = [0.911438 0.411438];
case 4
    HkOneSided = [0.971960 sqrt (2) / 2
0.235147];
otherwise
    return
end
```

where,  $L = numFFT - 2 * numGuards$  is the number of complex symbols per OFDM symbol. The switch function itself for given value of the overlapping factor  $K$  (value of 2, 3 or 4) consists of three statements that evaluate the values of the PHYDYAS filter in the frequency domain. MATLAB's function "*periodogram* ()" was used in this research in order to estimate PSD for given inputs as shown below:

```
[specFBMC, fFBMC] = periodogram (txSig,
rectwin (length(txSig)), numFFT*K*2, 1);
sumFBMCspec = sumFBMCspec + specFBMC;
txSigAll (:,symbolNr) = txSig;
```

where,  $txSig$  is constant that stores the calculated IFFT value of the transferred symbol. It is calculated as:

$$txSig = scFactor * \text{fftshift}(\text{ifft}(X));$$

where  $scFactor = KF / \sqrt{KL}$  in which  $KF = K * numFFT$  and  $KL = K * L$ ;  $\text{fftshift}()$  is a function that is shifting the zero - frequency component to the center of the array ( $X$  array) and  $\text{ifft}(Y)$  function that checks if the vector in  $Y$  is symmetrical.

$\text{rectwin}(L)$  is a function that returns a rectangular window of length  $L$ ;  
 $numFFT$  is the number of FFT points;  
 $K$  is overlapping factor;

Finally, the transferred signals for all symbols are stored in the  $txSigAll$  constant which is calculated with function *complex()* from MATLAB which has the task to create a complex output from two real inputs.

#### B. Design of prototype filter for FBMC and OFDM

In addition are given the parameters we use for calculating the prototype filter of both waveforms, respectively.

For FBMC - OQAM, we input the following:

- $M=16$ , where  $M$  is the number of sub – channels;
- $K = 4$ , where  $K$  is the overlapping factor;
- $lp = K*M - 1$ , where  $lp$  is the prototype filter length;
- $y = [1 \ 0.97195983 \ \text{sqrt}(2)/2 \ 0.23514695]$ , where  $y$  is the coefficient of filter when  $K = 4$
- $yy = [1, \ 0.911438 \ 0.411438]$ , where  $yy$  is the coefficient of filter when  $K = 3$  and
- $yyy = [1 \ \text{sqrt}(2)/2]$ , where  $yyy$  is the coefficient of filter when  $K = 2$

The rule for the given input is:

$$u = lp - 1;$$

$$s = 2 * \pi / (K * M);$$

Using the FOR loop cycle we can calculate the prototype filter for the given factor  $K$  as follows:

```
for m = 0 : u - 1
    r = m + 1;
```

The prototype filter equation for  $K = 4$  is:

$$p1(m+1) = y(1, 1) - 2 * y(1, 2) * \cos(r * s) + 2 * y(1, 3) * \cos(2 * r * s) - 2 * y(1, 4) * \cos(3 * r * s);$$

The prototype filter equation for  $K = 3$  is:

$$p2(m+1) = yy(1, 1) - 2 * yy(1, 2) * \cos(r * s) + 2 * yy(1, 3) * \cos(2 * r * s);$$

The prototype filter equation for  $K = 2$  is:

$$p3(m+1) = yyy(1, 1) - 2 * yyy(1, 2) * \cos(r * s);$$

while, for OFDM prototype filter we change the FOR loop cycle as shown in Matlab's workspace:

```
for m = 0 : M - 1
    p4(m+1) = 1;
end
```

Using the Open Filter Visualization Tool – fvtool() we can display the phase response, impulse response, group delay and coefficients of the prototype filter. In this case, we use it to display the magnitude responses as follows:

```
fvtool(p1, 1, p4, 1)
legend('FBMC', 'OFDM')
fvtool(p1, 1, p2, 1, p3, 1)
legend('K=4', 'K=3', 'K=2')
```

#### IV. DISCUSSION OF THE RESULTS

There are few remarks that were noticed during the simulations performed in MATLAB, such as the difference between FBMC and OFDM which is based on their PSDs and magnitude response of their prototype filter. The main change made in OFDM is the replacement of the cyclic prefix with the FBMC's filter banks at the receiver and transmitter side. The absence of cyclic prefixing increases the bandwidth efficiency and reduces the transmission of signals outside the designated frequency band.

Power spectral density of FBMC signal is designed to give low out – of – band leakage. As shown on Figure 1, the FBMC PSD curve has lesser side lobes.

An advanced utilization of the allocated spectrum is allowed for this characteristic leading to higher spectral

efficiency. Compared to FBMC, the OFDM has higher side lobes and *out of band* leakage.

Because FBMC - OQAM uses a pulse shape, a much better localization of the prototype pulse is achieved, as shown in the simulation results on Figure 2.

There is no need of using any CP to simplify the equalization process which leads to increased spectral efficiency. It also provides high flexibility for spectrum allocation with clear applications such as cognitive radios and the Internet of Things.

The both simulations show that the disadvantages of OFDM technique have been addressed and removed in FBMC and confirm, that the FBMC technique is the most promising waveform contender for future wireless communications specially 5G telecommunications

#### V. IMPLEMENTING 5G IN THE REPUBLIC OF NORTH MACEDONIA - STATE OF THE ART

Given the fact that North Macedonia is the first country in Europe that has whole IP based network, the relevant regulatory bodies have already taken the appropriate measures in order to keep pace with the trending technologies.

In the beginning of 2019, the government adopted the National Operational Broadband Plan, which is in line with the European Union strategic goals. According to this plan, it is estimated that by the end of 2023, at least one city in North Macedonia will have 5G coverage and by the end of 2027 all cities will be covered with an uninterrupted 5G signal. Also, it is expected that by the end of 2029, every citizen will have access to 5G Internet with a minimum speed of 100 megabits per second.

For successful introduction of the 5G mobile technology it is crucial for IT sector, telecommunication operators and vertical sectors to cooperate with each other. For that purpose, 4 groups are created and will work towards determining the necessary activities, free capacities and will provide a better coordination of the mapping process on the country's territory with existing and future broadband networks.

The implementation of 5G with all its advanced functionalities will fulfill the requirements in aspect of better customer service, spectral efficiency and low latency of digital radio infrastructures. In order to achieve this, a sufficient amount of appropriate radio frequencies will be required and allocated according to the regulations given by the Agency for Electronic Communications (AEC) [10]. The existing operators in the country can use the radio frequency spectrum of approximately 1000 MHz, which can also be used for 5G.

The operator that has made a step towards the introduction of this technology, is Makedonski Telekom which made the first 5G demo and has measured the highest data transfer speed so far, of over 500Mbps for downloading.

Also, in collaboration with the scientific community, Telekom opened a "5G Evolution Laboratory", that will enable the students and professors to be the first to work on the functionalities of 5G and test its benefits. The obtained results will be used for scientific purposes and improvement of services.

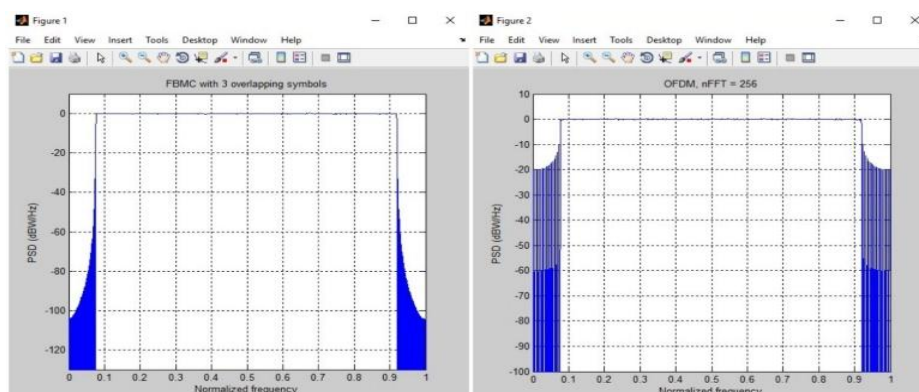

Figure 1. Power spectral density of FBMC (left) and OFDM (right)

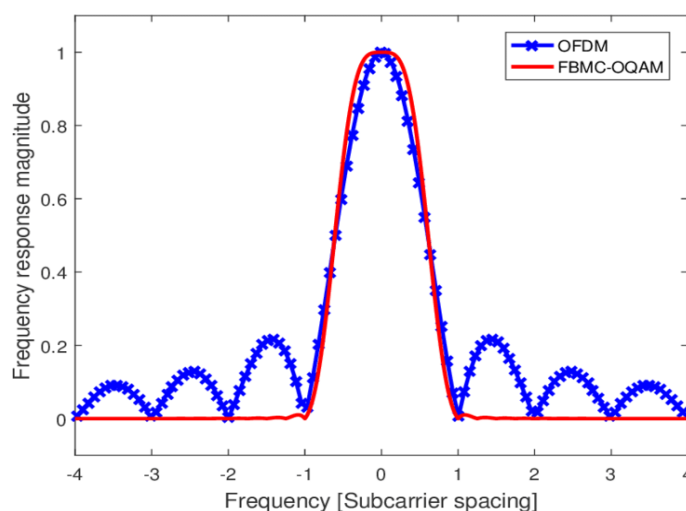

Figure 2. Magnitude responses of prototype filter

## VI. CONCLUSION

5G technology is packet based wireless system with expanded area of coverage and high throughput.

In this research, the comparison of FBMC and OFDM as the most competitive candidates for 5G has been carried out and simulated using MATLAB in terms of Power Spectral Densities and magnitude responses of their prototype filter and simulation results show that the drawbacks of OFDM have been addressed and removed with the implementation of FBMC. FBMC gives overall performance improvement which makes it an ideal candidate for future development of 5G.

The process of implementation of the 5G technology throughout Europe is planned to start in 2020. This process in our Country is in the initial phase but it is realistic and allows increasing the quality of service for the end users.

Despite all the challenges and regulations that are dealing with, the operators still have ambitious plans for the development of the optical network which only proves that Macedonia will welcome the entry of next generation networks - 5G technology, well prepared.

## REFERENCES

- [1] 5GPPP Architecture Working Group, View on 5G Architecture, White paper, EU, Dec, 2017.
- [2] A. J. Ramadhan, "Implementation of 5G FBMC PHYDYAS prototype filter", <https://www.researchgate.net/publication/324438033>.
- [3] A. Gupta, Dr. A. Gupta, S. Gupta, "5G – The future mobile wireless technology by 2020", International Journal of Engineering Research & Technology, Volume 2, Issue 9, September – 2013.
- [4] International Telecommunication Union, Functional requirements and architecture of the NGN, 2012.
- [5] ITU towards "IMT for 2020 and beyond", <https://www.itu.int/en/ITU-R/study-groups/rsg5/rwp5d/imt-2020/Pages/default.aspx>.
- [6] F. Schaich and T. Wild, "Waveform contenders for 5G — OFDM vs. FBMC vs. U-FMC," *2014 6th International Symposium on Communications, Control and Signal Processing (ISCCSP)*, Athens, 2014, pp. 457-460.
- [7] P. Kansal, A. K. Shankwar, "FBMC vs OFDM Waveform Contenders for 5G Wireless Communication System", *Wireless Engineering and Technology*, 2017, 8, pp. 59-70.
- [8] FBMC vs. OFDM Modulation, [https://fr.mathworks.com/help/comm/examples/fbmc-vs-ofdm-modulation.html?s\\_tid=mwa\\_osa\\_a](https://fr.mathworks.com/help/comm/examples/fbmc-vs-ofdm-modulation.html?s_tid=mwa_osa_a).
- [9] B. Farhang-Boroujeny, "OFDM Versus Filter Bank Multicarrier," in *IEEE Signal Processing Magazine*, vol. 28, no. 3, pp. 92-112, May 2011. doi: 10.1109/MSP.2011.940267.
- [10] Agency for electronic communications, <http://www.aek.mk/index.php?lang=en>.

# Optimizing Bluetooth Communication between Medical Devices and Android

L. Tanaskoska, A. Stamenkovska, S. Savoska, I. Jolevski, N. Blazheska–Tabakovska and B. Ristevski  
“St. Kliment Ohridski” University, Faculty of Information and Communication Technologies  
Bitola, Republic of North Macedonia  
lencetanaskoska@gmail.com, andrea.stamenkovska@gmail.com,  
snezana.savoska@fikt.edu.mk, ilija.jolevski@fikt.edu.mk, natasa.tabakovska@fikt.edu.mk,  
blagoj.ristevski@fikt.edu.mk

**Abstract - Healthcare is one of the biggest consumers of emerging information and communication technology, especially when the wide range of people have to use healthcare devices. With the concept of Internet of Things, these trends increase permanently as ubiquitous connected devices toward implementation of m-health concept. Usually devices are connected with Bluetooth that has many communication obstacles. Our research intends to provide some experience in optimizing Bluetooth communication between a couple of medical devices with Android application. Through usage of devices intended for short time tele-monitoring of the distance patient in the IPA 2 project Cross4all, we provide some extended experience for implementation of selected devices and gaining data suitable for wider use in the patients’ Personal Health Record (PHR).**

## I. INTRODUCTION

Nowadays, healthcare information technology is a worldwide trend. Healthcare information technology is applied information technologies to medicine and healthcare which supports health information management across computerized systems as well as secure exchange of health information between consumers, providers and monitors. These technologies have many benefits as the ability to store and retrieve data, enable communication between healthcare stakeholders, provide medication safety that is improved through the use of suitable secure technology and medication alerts, increasing ability for getting patients’ health tracking data as well as patient access to their medical records, known as Personal Health Record (PHR).

On the other hand, the rapid development of information technology is attracting more and more medical institutions to accelerate the use of healthcare information technology and assistive living technology [1]. Also, there is an increasing interest in the production of devices that enable monitoring of healthcare connected data such as blood pressure, blood sugar, heart rate etc. [2]. The rapid development of mobile applications provides a new development direction for the medical industry and pervasive computing [3]. As one of the most commonly used mobile operating system in the world is Android, as

an open source mobile operating system based on Linux platform, it is also the most used for development of mobile application toward the concept named mobile health (m-health) [2, 4]. With its open and convenient development mode has occupied an important position in the field of mobile applications. But the possibility of communication between Android devices and health monitoring devices known as BLE devices is due to Bluetooth Low Energy (BLE) [5].

We have to highlight what is BLE device and how to communicate with them. Bluetooth low energy device is a device that communicates with other devices using Bluetooth [6]. It’s a simple device which can send and receive data as a byte array. In order to read data from the device you must connect with it. To connect with it, there are steps that must be taken. First, you have to scan for the device. For that purpose, we are using the default Bluetooth scanning service from Android. For each discovered BLE device we are receiving event and data specific for that device. Once we discover the wanted device we connect with it. Next, we need to make the communication with the device or retrieve the data we need. Each BLE device has a communication interface that is exposed through services and characteristics. A characteristic is as a command or function, it’s a place you read or write to fetch data or control the device. Each characteristic can also have one or more descriptors that tend to be accessed less frequently by application code. Services are collections of characteristics, group of related commands/functions. Also, each service and characteristic has a universally unique id (UUID) that is used when setting up the communication with the BLE device [7]. There UUIDs are usually found in the device documentation provided by the manufacturer.

For the project Cross4all from IPA2 program, cloud based architecture is created [8] with development of PHR that have to be the main base of collecting valuable healthcare data for patients cross border. As a part of patients’ PHR data, data collected from short time monitoring period have to be provided using m-health concept. So, we start to collect these data from selected devices connected to patient, sending then into cloud database. We worked



on the Medisana devices equipped with Bluetooth. According to project's demands and m-health principle, we worked on optimizing the Bluetooth communication between these medical devices and Android device in order to gain better results from intended devices.

The rest of the paper is organized as follows. After Introduction, related works are described in Section II. The proposed optimization processes are explained in the next section. Results and discussions are provided in the fourth section. Concluding remarks highlight some future work intended for the project and propose some improvement of the proposed concept.

## II. RELATED WORKS

Considering that migration and traveling of the people increase all the time, people as patients are more and more mobile and change their need for healthcare. Many times, they use electronic health methods as e-health and m-health to satisfy their need for healthcare. There is an arising need of medical facts for patients also because of providing evidence based medicine [9, 10]. A lot of researchers' work provide a new concepts and methodologies in order to enable measuring instruments, devices and other equipment for this objective, especially devices according to the concept Internet of Things (IoT). One of the best solutions to support these new trends is collected healthcare data from all patients' healthcare activities, medical examinations, laboratory results, prescription and referral. All these data have to be stored in some healthcare digital repositories in electronic format as Electronic Health Records (EHR) or PHR [11], saved and accessible for the patients or selectively by medical staff [12]. All stored data and medical information play a positive role in medical practitioners' decision making for the patient healthcare.

The growth of using mobile and ubiquitous computing technologies contributes to increase the number of records regarding personal health of patients. IoT includes the development of wearable measurement sensors connected with Bluetooth, which are capable to capture and store health-related data, intended to store in PHR [3, 11]. As the mobility increasing, researchers give special attention to data security and privacy because of healthcare data sensitivity. Silva et al. proposed encryption solution, called data encryption for mobile health applications (DE4MHA), trying to guarantee the best confidentiality, integrity, and authenticity of m-health systems users' data [13].

Many efforts are made to create e-health and m-health application last two decade. Some authors highlighted some extensible, scalable, highly interoperable and customizable platforms that provide cloud based architecture, based on components and services architecture. It can be used to develop several remote mobile monitoring m-health systems [14].

All the technologies in the field of medical tele-monitoring, such as devices and mobile applications must be suitable for the user's cognitive abilities [18]. They have to be easy-to-use and user-friendly, particularly when they are used by elderly people and people with disabilities.

With the arise usage of IoT concept, m-health is widely used as medical help for medical practitioner, especially for cardiovascular research and patients' health monitoring [4]. Some medical m-health/e-health vendors already have their own platform that are connected with their own cloud with included data encryption and protect data from wider usage. Bluetooth connection can be sometimes insecure and for this reason, they provide accounts with secure data control and Service oriented architecture [5].

M-health also has the potential to promote patient's self-management, especially for high risk patients as hypertension and cardiovascular disease, as a complement to the doctor's intervention [15]. They encourage greater participation in medical decision making. With cloud based m-health, the medicine is empowered with tools which bring data for evidence based medicine [1]. There are a lot of solutions for mobile monitoring as m-health solution. The concept MoMo (Mobile Monitoring) Framework is a solution that allows for patient mobile monitoring through mobile phones and biometric devices (blood pressure meter, glucometer and others) and is widely spread nowadays [16]. All of these devices usually have Bluetooth and some similar solution for data collection. So, optimization of such connection can give very promising results for data collection.

## III. USED DEVICES AND OPTIMIZED BLUETOOTH COMMUNICATION WITH ANDROID OS

### A. First Insights

At the beginning of the project we have experienced several personal healthcare devices produced by Medisana corporation: Medisana Blood Pressure Monitor BU550, Medisana Pulse Oximeter PM 150 and Medisana Blood Glucose Monitor MediTouch 2 listed in Table I. Each of these devices supports different communication services and monitors different health related data. While trying to establish communication with the devices we encountered several problems. The first problem was that with some devices it was possible to connect only after the values had been measured, while for other it was possible at the beginning while the measurement was in progress. Another problem we encountered was unexpected disconnection of the devices during communication, and the last problem was that not all devices were using the UUIDs that were specified in GATT standard [17]. Due to the above problems we had to make optimizations in order to have better and valid communication with the devices via BLE.

### B. Proposed optimization

Due to the growing popularity if M-health, a number of mobile applications have been developed that allow communication with BLE devices and can

be found on the Google Play Store. However, most of them only communicate with one specific device and are not user friendly for elderly people and people with disabilities. For this purpose, we have developed application that will enable communication with multiple personal healthcare devices while being user friendly. We developed an application that provides a view of all the measurements made on the devices listed in the Table 1, then option to filter the measured data by day, week, month and graph representation of it, storing data in the cloud, additional analysis and statistics, as well as early detection and prevention of health disorders.

Table I. Services and characteristics for devices.

Type	BLE, GATT
Medisana BU550 - Blood pressure monitor	One service One characteristic
Medisana PM 150 - Pulse Oximeter	One service Five characteristics
MediTouch 2 - Blood Glucose Monitor	One service Three characteristics

Medisana blood pressure Monitor BU550 connects works the same as any other BLE device, using the same protocol for connecting with the Android device as described above. So, the first step in the communication process is to verify that the device we are trying to connect supports Bluetooth and has granted permissions for Bluetooth and location by checking for `BLUETOOTH`, `BLUETOOTH_ADMIN`, `ACCESS_COARSE_LOCATION` and `ACCESS_FINE_LOCATION` permissions in Android OS. If these particular permissions are not granted we must request permissions in order to proceed, but if permissions are granted, the next step is to ensure that the user has enabled Bluetooth. Also, it checks that we are using `BluetoothAdapter` class from Android SDK. When we have granted permissions and enabled Bluetooth we can allow the user to scan for BLE devices. Using the `startDiscovery` method from `BluetoothAdapter` class we are starting the scan for BLE devices, but firstly we need to register broadcast receiver which will listen for data/packages from BLE devices and when receives a package will notify us that the BLE device has been discovered. When we register the receiver, we also set filter with action `FOUND`, so when the `onReceive` method would be called we could compare the action from the intent that we just received with action `Found`. If the action from the intent we received equals to action `FOUND` we can get the extra data that the intent is carrying. The intent that we receive is holding an amount of data that might be useful to us. The data is stored in some type of map where each data part is associated with a key. The key that is associated with object that has

data about the device that we discovered is `"android.bluetooth.device.extra.DEVICE"` or we can find it as static property in `BluetoothDevice` class as `EXTRA_DEVICE`. The associated object with this key is of type `BluetoothDevice` and has multiple properties that we can use such as the name of the device, its mac address, type, alias, alias name, battery level, if it's connected or encrypted and the most important property the array of UUIDs that this device is supporting.

Other than these useful properties the `BluetoothDevice`, class has methods that we need to use in order to get data from the BLE device such as `createBond` for creating a bond and pairing with the device and `connectGatt` for actual connection with desired device. `ConnectionGath` method has multiple implementations with various numbers of parameters and we should choose the one implementation that suits the best. In this case we are using `'connectGatt (Context context, Boolean autoConnect, BluetoothGattCallback callback)'` where the `autoconnect` is set to true and we are passing callback of `BluetoothGattCallback` type. It's best to have its own class for each device we want to implement. The custom class should extend `BluetoothGattCallback` class and override its methods such as `onConnectionStateChange`, `onServicesDiscovered`, `onDescriptorWrite`, `onDescriptorRead`, `onCharacteristicRead` and `onCharacteristicChanged` which we will use in the further communication.

As mentioned before each device has its unique identifiers called UUID that we use for communication. They can be service uuid, characteristic uuid or descriptor uuid. Each device has one or more services, each service has one or more characteristics and each characteristic has one or more descriptors. Medisana Blood Pressure Monitor BU550 has multiple services and the most important service for us is the blood pressure service with uuid: `'00001810-0000-1000-8000-00805f9b34fb'`. From this service the characteristics that we need is the one with uuid `'00002a35-0000-1000-8000-00805f9b34fb'` and in order to get data we'll need descriptor with uuid `'00002902-0000-1000-8000-00805f9b34fb'`. These uuid-s can be found in the `BluetoothDevice` object that we receive in `onReceive` method.

After we call `connectGatt` method we are waiting for data in the callback we passed as parameter. `OnConnectionStateChange` method will be first called to notify us that connection state changed. In this method we are receiving `BluetoothGatt` object which we will use to retrieve data, the current status of the ble device which can be disconnected (state 0), connecting (state 1), connected (state 2) and disconnecting (state 3) and the new state of the ble device. If we receive status 2 (connected), then we can call `discoverServices` method of the `BluetoothGatt` object that was received in `onConnectionStateChange` method. This is an asynchronous operation so when the discovery is completed the `onServiceDiscovered` method will be

called as the callback will be triggered by the operation.

Once the service is discovered we need to setup the characteristic and the descriptor in order to properly receive data. We are using BluetoothGatt object that we receive as a parameter within the onServiceDiscovered method to call setCharacteristicNotification method so we can enable notifications for the characteristics that we need to retrieve data. After that we need to enable indication or notification on the descriptor. Which value will be set depends on the properties of the characteristic we are using to get data. For Medisana Blood Pressure Monitor's descriptor we are setting enable notification as value.

When it's all setup the only remaining thing is to wait for the callback to trigger onCharacteristicChanged method. In this method we are receiving BluetoothGatt object and BluetoothGattCharacteristic object. BluetoothGattCharacteristic object's property value consist the data that we are waiting to receive. Calling the getPropertyValue will give us byte array with the data of the measurement of the device.

Because we need to parse the data into readable form, we need to parse the byte array into hexadecimal string. The hexadecimal string contains a lot of information, but the ones that we need are systolic, diastolic and heart rate value. For systolic value we need to get the second and the third character from the hexadecimal string and parse it to integer, for diastolic value we need to get the sixth and seventh character from the hexadecimal string and parse it to integer, and for the heart rate value we need to get the 28th and 29th character from the hexadecimal string and parse it to integer. The onCharacteristicChanged method will be called as many times as there are records in the memory of the device, so the best practice is to wait a couple of seconds after each data received. If there is no following onCharacteristicChanged call it means that we have received the last and the latest measurement.

Although the main course of the communication with the Medisana Pulse Oximeter is relatively the same as Medisana Blood Pressure Monitor, there are some differences. The main difference is that the Pulse Oximeter for transmitting data uses specific service with UUIDS outside of the ones specified with GATT standards code, the UUID of that service is 'ba11f08c-5f14-0b0d-1080-007cbe3d328f'. For the Medisana Blood Pressure communication we were using only one characteristic with one descriptor, but to setup the pulse oximeter we need multiple characteristics and they all use the same descriptor (uuid: '00002902-0000-1000-8000-00805f9b34fb').

The characteristics with following UUIDs: '0000cd02-0000-1000-8000-00805f9b34fb', '0000cd03-0000-1000-8000-00805f9b34fb', '0000cd01-0000-1000-8000-00805f9b34fb', '0000cd20-0000-1000-8000-00805f9b34fb' only need their descriptors to be set to enable sending

notification by setting the value to the byte array {0x01, 0x00}. We need to make sure that the characteristics will be set one at a time, so we will need to wait for onDescriptorWrite method to be called so we can setup the descriptor of the next characteristic. When we are finished with the three characteristics on the last onDescriptorWrite call we need the characteristic with UUID '0000cd04-0000-1000-8000-00805f9b34fb'. This characteristic is specific because we need to write specific byte array {(byte) 0xaa, (byte) 0x55, (byte) 0x04, (byte) 0xb1, (byte) 0x00, (byte) 0x00, (byte) 0xb5} by setting the value property to the characteristic and then using the writeCharacteristic method of GATT object to write the data which will allow the device to send data to the android application. After all is set, we are waiting for onCharacteristicsChanged method call. This method will be called only once as we receive only the currently measured data as byte array from which the third byte is the saturation value and the fourth byte is heart rate value. We need to parse the received data to hexadecimal string and then to integer in order to get the real value.

The communication with MediTouch 2 - Blood Glucose Monitor is very similar with Medisana Blood Pressure Monitor, because unlike the Pulse Oximeter we do not need to write data using the characteristics we need to enable the notifications of the characteristics descriptors (one at a time) and wait for onCharacteristicsChanged method to be called. For communication we are using the service with UUID '00001808-0000-1000-8000-00805f9b34fb' and characteristics with UUIDs '00002a18-0000-1000-8000-00805f9b34fb', '00002a34-0000-1000-8000-00805f9b34fb' and '00002a52-0000-1000-8000-00805f9b34fb'. The onCharacteristicsChanged will be called as many times as the number of measurements in the device memory so we should use the same practice as the one for Medisana Blood Pressure Monitor. The last method call will provide the current measurement as byte array.

As we mentioned before, many classes already made by the device vendors are used. Some of the classes are made for this purpose. Fig. 1 shows the class diagram created for the purpose of this research and class connections. The most important class is BleManager class which consists of methods that help with the communication and the most important thing is that it is a singleton so we will be sure that the communication with different devices will not be mixed up. This class has startScanPeriodically public method that allows us to scan by device type and as long as it's needed to find the device. The list of the devices is managed by DevicesFragment class and the user can choose device by clicking on a list, which invokes the startScanPeriodically method. Periodical scan is managed by the BleHandler class which extends Android's Handler class and schedules repeatedly stopping and starting the Bluetooth scan.

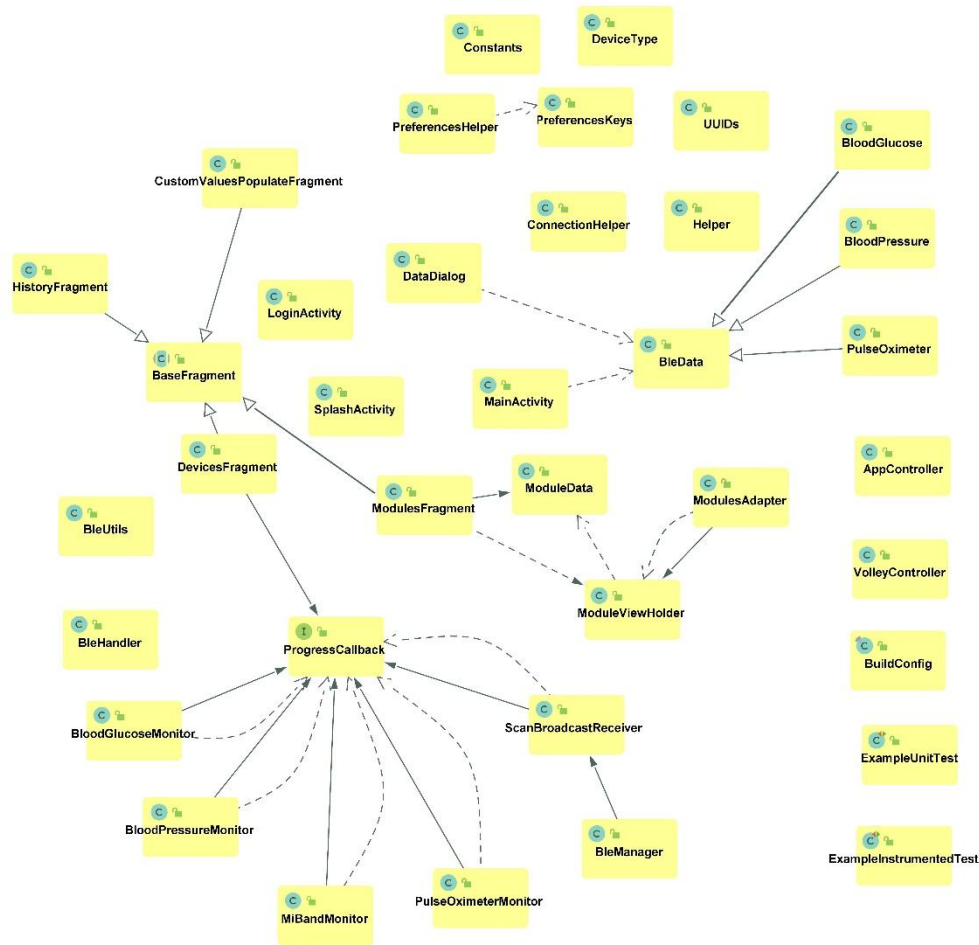

Figure 1. UML Class diagrams used for the application.

Before the scan has started we are using `ScanBroadcastReceiver` class to register a receiver for the specified device. The `ScanBroadcastReceiver` class has `onReceive` method that handles whether the received device is the one that we need. Once the device is discovered we are using a class of `BluetoothGattCallback` type to handle whole communication. For each device we have created `BloodGlucoseMonitor`, `BloodPressureMonitor`, `MiBandMonitor` and `PulseOximeterMonitor` classes that implement all needed `BluetoothGattCallback` methods. `BleDeviceState` enumeration and `BleUtils` class help within the communication process. Also, we have created `ProgressCallback` interface in order to pass data to the devices fragment or where is needed and to control the progress that is displayed. For collecting the data we have one general type `BleData` class and classes for each measurement such as `BloodGlucose`, `BloodPressure`, `PulseOximeter` that extend the `BleData` class. When the data is received we are using `DataDialog` class for visual display.

#### IV. RESULTS AND DISCUSSIONS

Integrating different BLE connected healthcare devices is a difficult task since the different ways of organizing the communication protocol and entities per device and per vendor. Although the Android ecosystem is trying to overcome this multiverse with introduction of the Google FIT API, vendors still are

not in unison. On the other side the users of such devices are forced to use different healthcare application per device and thus having their healthcare measurement data scattered over several apps and clouds. Creating customizations per device has led us in creating software structures and Java classes that can be used as templates in future integrations of other BLE based healthcare measurement devices.

In this paper we use the described optimized healthcare application, providing direct Bluetooth communication between the healthcare measurement devices and Android tablet, avoiding communication with vendor's cloud and obtaining a fastest direct communication (Fig.2). Also, our solution integrates all mentioned devices (Table 1) and thus decrease usage complexity for the end user since they do not need to learn to use different apps for every different medical device. Evaluation and testing of solution is done on devices from Table 1 on small number of trial users in Bitola. It will provide a base for the bigger pilot project in Ohrid municipality, with main purpose to collect PHR data in the CROSS4ALL project cloud store.

#### V. CONCLUSION

The research we made enables development of mobile healthcare applications with customized and

optimized communication stack and procedures with different BLE enabled healthcare devices, as shown on Fig. 2. It will contribute to a better and easier access to personal healthcare devices and use by elderly people and people with disabilities, then better and easier access to measured data by doctors and users themselves, reducing costs and providing better healthcare services to all patients. In this way, we provide an example how customized devices can be used with Bluetooth connection in healthcare application providing data for patients that can be stored and analyzed as data for evidence-base medicine and help in decision making processes of diseasediagnose, drug prescription or referral.

This paper may be a potential starting point of more broadly defining the design and templates for the medical data transfer data classes and BLE communication classes for Android OS.

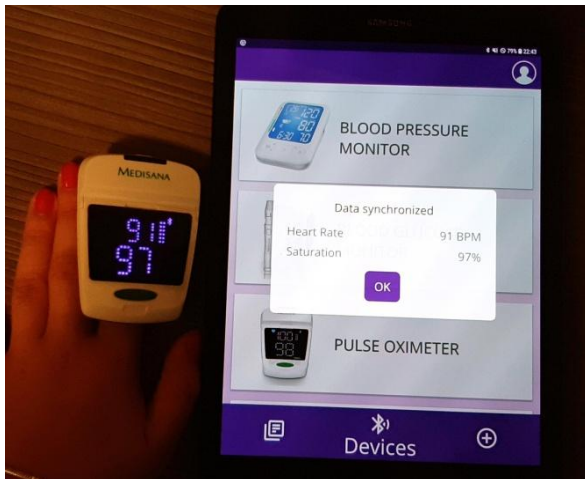

Figure 2. Synchronizing data between medical device and mobile application.

#### ACKNOWLEDGMENTS

Part of the work presented in this paper has been carried out in the framework of the project "Cross-border initiative for integrated health and social services promoting safe ageing, early prevention and independent living for all (Cross4all)", which is implemented in the context of the INTERREG IPA Cross Border Cooperation Programme CCI 2014 TC 16 I5CB 009 and co-funded by the European Union and national funds of the participating countries.

#### REFERENCES

[1] Kravets A., Shcherbakov M., Kultsova M.&Shabalina O. (Editors), Creativity in Intelligent Technologies and Data Science, First conference, CIT&DS 2015 Volgograd, Russia, September 15–17, 2015 Proceedings, Springer, pp.

[2] BerloA.and all (Editors), Ambient Intelligence – Software and Applications, 4th International Symposium on Ambient Intelligence (ISAmI 2013), Springer (2013)

[3] Aleksov V., Savoska S., Trajkovic V., Applications of pervasive computing and mobile services in health care, In proceedings of ISGT 2018 conference, Sofia November 2018;

[4] Chaudhry M.S. Sarwar, MuthiahVaduganathan, Stefan D.,Anker, Stefano Coiro, Lampros Papadimitriou, Joel Saltz, Elinor R. Schoenfeld, Richard, L. Clark, Wilfried Dinh, Frank Kramer, Mihai Gheorghiad, Gregg C. Fonarow, Javed, Butler, Mobile health applications in cardiovascular research. Ijca (2017), doi:10.1016/j.ijcard.2018.06.039

[5] Developers web site, <https://developer.android.com/guide/topics/connectivity/bluetooth-le>, Accessed 10.9.2019

[6] PUBMED, US national library of medicine, <https://www.ncbi.nlm.nih.gov/pubmed/28508815>, Accessed 5.8.2019

[7] Bluetooth web site for UUID, <https://www.bluetooth.com/specifications/assigned-numbers/16-bit-uuids-for-members/>, Accessed 10.8.2019

[8] Savoska S., Jolevski I., Architectural Model of e-health System for Support the Integrated Cross-border Services, In proceedings of ISGT 2018 conference, Sofia November 2018

[9] Dagnano S. and Macherone A., Editors, Unraveling Exposome, © Springer international publishing, 2019; Smith M.T. and all, Chapter 1: Using Exposomics to Assess Cumulative Risks from Multiple Environmental Stressors, pp.3-22

[10] Andreu-Perez J, Poon CC, Merrifield RD, Wong ST, Yang GZ. Big data for health. IEEE J Biomed Health Inform 2015 Jul;19(4):1193-1208. [doi: 10.1109/JBHI.2015.2450362] [Medline: 26173222]

[11] Roehrs A. and all, Personal Health Records: A Systematic Literature Review, Journal of Medical Internet Research, 2017;19(1):e13, doi:10.2196/jmir.5876

[12] Gay K. and all, Electronic Health Record Error Prevention Approach Using Ontology in Big Data, 2015 IEEE 17th International Conference on High Performance Computing and Communications (HPCC), 2015 IEEE 7th International Symposium on Cyberspace Safety and Security (CSS), and 2015 IEEE 12th International Conf on Embedded Software and Systems (ICESSE), DOI: DOI 10.1109/HPCC-CSS-ICESSE.2015.168

[13] Silva B.M.C.and all, Towards a Cooperative Security System for Mobile-Health Applications,

[14] Ángel Ruiz-Zafra, Kawtar Benghazi, Manuel Noguera, and José Luis Garrido, Zappa: An Open Mobile Platform to Build Cloud-Based m-Health Systems (in: BerloA.and all (Editors), Ambient Intelligence – Software and Applications, 4th International Symposium on Ambient Intelligence (ISAmI 2013), Springer (2013))

[15] Omboni S. and all, Telemedicine and M-Health in Hypertension Management: Technologies, Applications and Clinical Evidence, High Blood Press Cardiovasc Prev DOI 10.1007/s40292-016-0143-6, Springer, 2016

[16] Villarreal V. and all, A Systematic Review for Mobile Monitoring Solutions in M-Health, J Med Syst (2016) 40:199 DOI 10.1007/s109, 6-016-0559-5, Springer, 2016

[17] GATT standards web site, [http://dev.ti.com/tirex/content/simplelink\\_cc2640r2\\_sdk\\_1\\_40\\_00\\_45/docs/blestack/ble\\_user\\_guide/html/ble-stack-3.x/gatt.html#](http://dev.ti.com/tirex/content/simplelink_cc2640r2_sdk_1_40_00_45/docs/blestack/ble_user_guide/html/ble-stack-3.x/gatt.html#), Accessed 10.8.2019

[18] Jankowski, Natalie, Laura Schönijahn, and Michael Wahl. "Telemonitoring in home care: creating the potential for a safer life at home." In *Safe at Home with Assistive Technology*, pp. 81-93. Springer, Cham, 2017.

# Development of an Educational Augmented Reality Application

M. Zlatkovski, B. Ristevski, S. Savoska, N. Blazheska Tabakovska and A. Bocevska

Faculty of Information and Communication Technologies – Bitola

“St. Klement Ohridski” University - Bitola

Ul. Partizanska bb. 7000 Bitola, Republic of North Macedonia

milanzlatkovski@gmail.com, blagoj.ristevski@fikt.edu.mk,

snezana.savoska@fikt.edu.mk, natasa.tabakovska@fikt.edu.mk, andrijana.bocevska@fikt.edu.mk

**Abstract** - The aim of this paper is to explain the application of augmented reality technology in various domains, particularly in development of educational applications. Firstly, the principles of the augmented reality are explained and the manner of its usages in a broad spectrum of fields, such as medicine, education, entertainment, game, sport, architecture and tourism. We have compared most commonly used technologies and tools for development of augmented reality applications. Unity is a part of the advanced computer graphics technologies that improve contemporary computerized life with ordinarily used games and various mobile applications. Unity is employing to develop 2D and 3D applications and to deploy them on different platforms. We have created an educational discovery-based augmented reality application by using Unity.

**Keywords:** computer graphics, augmented reality, programming languages and technologies, software development.

## I. INTRODUCTION

With the recent scientific and technological advances, people can even modify the real world around them. This is possible by using augmented and virtual reality technology. The augmented reality comes from the idea of mixing the virtual reality and the real world. Augmented and virtual reality tools and techniques create another enriched reality that has the same key features as the real world. Differently from virtual reality that immerses users in synthetic computer-generated environment, augmented reality combines real environment with virtual objects enriched with augmented components by using computer graphics. Augmented reality enriches information that existed in reality with information available in the digital devices [18]. Augmented reality allows the user to see the real world with synthetic objects superimposed or merged with real environment, thus bridging the gap between real and virtual world [14] [15]. This augmented reality feature makes smartphones to be very suitable platform for augmented reality applications.

Very famous examples of using augmented reality are the TV sport shows, where virtual (non-real) elements are added to the real pictures or scenes.

With the advance of the augmented reality, smart phones and tablets with their high performance processors, cameras and touch screens play a crucial role. All these components significantly increase the opportunities for using augmented reality technology in

various areas such as: medicine, marketing, sport, sales, entertainment, education, tourism, architecture and construction, military, manufacturing etc. For instance, in the domain of architecture, when a project for a new building is designed, the synthetic final building at the desired place can be seen by using augmented reality techniques. Moreover, when walking through the streets using augmented reality applications, it is possible to see how the buildings looked like hundreds years ago or how they will look like in the future after several years.

Advances in information and communication technologies enable their application in educational from teaching staff and students. Pupils and students in their ordinary life use numerous multimedia contents provided by the Internet, 3D movies and videogames [14].

Augmented reality has shown a great potential for application in education aiming to improve the effectiveness and quality of the teaching and learning process, especially in visualizing abstract concepts [12]. Augmented reality helps students to develop their visualization skills.

Augmented reality is used in discovery-based learning for recognizing places, persons or things and in preparing interactive course materials [15].

Among many existing learning approaches, digital game-based learning is very promising approach [17]. Many learning and teaching activities by using augmented reality can be simplified, more cost-effective and less time demanding.

Augmented reality in education leads to improvement of learning achievement and enhancement of learning motivation and spatial ability, thus avoiding teacher's repeating explanations [13] [14]. The authors in [21] [22] [23] has surveyed using augmented reality in different educational applications.

Nowadays, the big industrial leaders, such as Google, Apple, Microsoft, Facebook are already working on new augmented reality devices.

The remainder of the paper is structured as follows. A survey of software tools for development of augmented reality is given in Section II. The subsequent section describes the main features of Unity, while Section IV depicts developed educational augmented reality

application using Unity. The last section provides concluding remarks and direction for further work.

## II. SURVEY OF SOFTWARE DEVELOPMENT TOOLS FOR AUGMENTED REALITY APPLICATIONS

It was widely considered that the augmented reality technology is used only in games and entertainment. The focus of this paper is put on application of augmented reality in education for application development.

Augmented reality applications are categorized in two types:

- marker-based augmented reality applications and
- location-based augmented reality applications.

Marker-based applications use markers, which are previously defined, to trigger the presenting augmented reality objects in the original scenes. Most markers are black and white, although they can be colored, but contrast between colors should be accurately recognized by a camera. Simple augmented reality markers are consisted of one or more basic forms made up of black squares on white background [19], while the advanced augmented reality applications can recognize 3D markers and real-world objects.

Location-based augmented reality applications use GPS (Global Positioning System), accelerometers, or compass information to show objects in the original scene or environment.

When choosing the software for development of augmented reality applications, the following features should be taken into account: costs, supported platforms, image recognition and tracking, unity support, OpenSceneGraph support and GPS [1]. To choose most appropriate software for application development, we have compared mainly used augmented reality software.

### A. *Vuforia*

Vuforia is one of the best and most commonly used software for creating augmented reality applications [2], which has wide range of usages such as objects recognition including pictures. It accepts and recognizes text up to 100 000 words, creates its own unique marks (VuMarks) that are better than the typical QR. By using the tool Smart Terrain, it is possible to design a 3D map of any location, the static pictures are transformed in a video that can be played on any surfaces using Unity plugins and cloud and local storages.

### B. *ARToolKit*

ARToolKit is an open source library for creating augmented reality applications. It is a free, cross-platform that offers large sets of tracking tools. Its supportive properties and purposes can be described as: Unity3D and OpenSceneGraph, single and dual camera, augmented reality application based on location with GPS and design AR applications in real time. ARToolKit supports smart glasses as well as many programming languages.

### C. *Google ARCore*

Google ARCore is a software development kit designed from Google, which is very popular worldwide and useful among users. It is one of the best tools for designing augmented reality applications that works with Java, OpenGL, Unity and Unreal [2] [3] [4]. It has many different useful tools aimed for:

- Motion tracking. With ARCore, the position and orientation of the device using of camera and the location positions can be calculated. This enables easily putting any virtual object to the exact location.
- Environmental understanding. Google ARCore can recognize horizontal terrain, which helps to put virtual objects on tables or floors. This tool is also suitable for motion tracking.
- Light estimation. This feature enables the light balance of the surrounding and background by the lights of the virtual objects. This feature is very advantageous for developers to design very realistic scenes.

Some of ARCore supported devices are: Google Pixel, Pixel XL, Pixel 2, Pixel 2 XL, Samsung Galaxy S7-S8+, Samsung A5-A8, Samsung Note8, Asus Zenfone AR, Huawei P20 and OnePlus 5.

### D. *Apple ARKit*

Apple has created its own augmented reality software development kit for iOS11 [2]. Apple's augmented reality iOS SDK (Software Development Kit) features are:

- Visual Inertial Odometry. This feature allows environment tracking precisely without any further calibration.
- Robust face tracking feature, for adding effects on the face or design expressions of the faces of 3D characters.
- Tracking of the quantity of the surrounding area lighting to add necessarily lighting to the virtual objects.
- Apple ARKit can recognize horizontal terrain, such as tables and floor and to detect vertical and irregular shaped objects.
- Recognizing 2D objects that can be altered by users.
- Integration with Unity and Unreal Engine.

This is the list of supported devices: iPhone 6s and 6s Plus, iPhone 7 and 7 Plus, iPhone SE, iPad Pro (9.7, 10.5 or 12.9), iPad (2017), iPhone 8 and 8 Plus and iPhone X.

### E. *MAXST*

MAXST has two SDKs that developers can use: 2D SDK for image tracking and 3D SDK for environment recognition [1]. Here is the list of the 3D SDK features:

- MAXST Visual Simultaneous Localization and Mapping, used for tracking and mapping of the

environments. When the environment is tracked, the map is automatically expanded beyond the first view, as well as the move of the camera.

- Files created using Visual Simultaneous Localization and Mapping can be stored to render 3D objects. Also, those objects can be enriched by AR features.
- Scanning of QR codes and barcodes is enabled.
- It is possible to extend image tracking and Multi-target tracking. With this feature, you can track a target for a very long distance, or as long as it is on the reach of the camera's view.
- It provides tracking of digital object placing them in association with the plane.

This tool supports integration of Unity plugin and it works on Android, iOS, Mac OS and Windows operating systems.

#### F. Wikitude

Wikitude is a technology provider, used mainly for creation of mobile augmented reality applications. Recently, Wikitude has launched their SDK 7, which supports simultaneously localization and mapping [1]. These are the key features provided by Wikitude:

- 3D recognition and tracking.
- Image recognition and tracking.
- Cloud recognition - ability to work with huge amount of targets, which are hosted on the cloud.
- Providing location-based services.
- Integration with smart glasses.
- Integration with external plugins, such as Unity.

Its SDK supports: Android, iOS and Smart Glasses.

### III. USING UNITY TO IMPLEMENT AUGMENTED REALITY APPLICATIONS

Unity is a multi-platform tool for creation of augmented reality applications and games. It was first developed by Unity Technologies in 2005. Since 2018, Unity has upgraded supporting more than 25 platforms. This tool can be used to develop 2D and 3D games, virtual and augmented reality applications, to make simulations. Unity is used in numerous branches, such as in film industry, automobile industry, architecture and engineering, entertainment, medicine and education.

Among many available software for augmented reality application, Unity is chosen because it is most cost-effective, flexible and sustainable solution for application development [16].

Unity is a part of the advanced technologies that improve contemporary computerized life with ordinarily used game and various mobile applications. Unity is employing to develop 2D and 3D applications and to

deploy them on different platforms. Unity is a cross-platform game engine that is supported on many different devices, such as mobile devices, augmented and virtual reality devices, desktop, web and console [10]. Developed games and applications can be used on different operating systems and platforms such as Windows, Android, Windows Phone, Tizen, iOS, Windows Store Apps, Mac, Linux/Steam OS, WebGL, PlayStation4, PlayStation Vita, Xbox One, Wii U, Nintendo 3DS, Oculus Rift, GoogleCardboard, Steam VR, PlayStation VR, Gear VR, Microsoft Hololens, Daydream, Android TV, Samsung SMART TV, tvOS, Nintendo Switch, Fire OS and Facebook Gameroom [7].

Description of the Unity features and tools is given as follows.

#### A. Well-ordered user interface

Unity has simple and easy-to-use design and user interface, shown on Fig. 1. The best feature of the program is fast and easy creation of the desired games or applications. Its basic function is collecting external scripts and contents. This allows fast and simple editing of the tools, products and documents.



Figure 1. Unity user interface.

#### B. Powerful graphics

Unity has very big and adjusted DirectX and OpenGL graphics that provides work in high resolution. This engine is sophisticated, modern and allows using very different designs.

#### C. Importing models

Unity allows importing models from the best 3D software tools such as Maya, Cinema4D, 3D MaxStudio, Cheetah3D, Moddo, Lightwave, Blender and SketchUp. Unity can read .fbx, .dae (Collada), .3ds, .dxf, .obj and .skp files.

#### D. Shadows

This tool, in Unity is simple, easy to use and adjustable, as shown on Fig. 2.

#### E. Network

Network system is connected with HTTP server, in order to connect to PHP. Collecting photos that could be used in 3D user interface is performed easily. Some new Unity models allow using Asset Store, for downloading objects that can imported simply into the project simply.



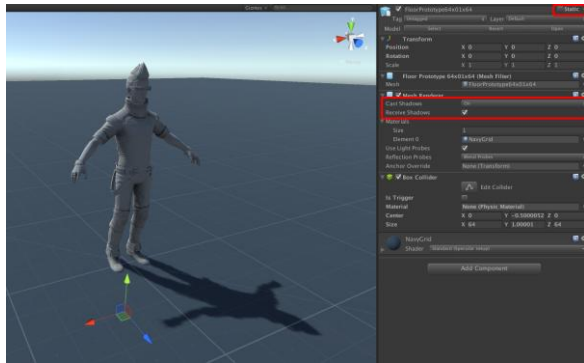

Figure 2. Shadows in Unity.

#### F. Video and audio

Combining the 3D graphical design with video and audio plays an important role in the producing of high quality applications. There is an option for using different audio formats (e.g. AIFF, WAV, MP3, Ogg) and video formats (MP4).

#### G. Scripting process

This is a complex process. The good side is the fact that there is an option to use different programming languages (e.g. C#, JavaScript and Boo). Unity automatically imports the MonoDevelop software that allows creating or modifications of the scripts.

#### H. Documentation

Nowadays, there are many available documents, studies and works, which can be very supportive during learning Unity.

### IV. DESCRIPTION OF CREATED EDUCATIONAL AUGMENTED REALITY APPLICATION

Among many existing learning approaches, digital game-based learning is very promising approach and it leads to improvement of learning achievement and enhancement of learning motivation, thus avoiding teacher's repeating explanations. Van Eck states that this learning approach is effective because learning takes place within a meaningful context and the subject is directly related to the environment in which students learn. As such, the knowledge gained is applied and practiced within that context [20].

The educational application is created by using Unity for Android platform. This platform was chosen because it is very suitable to develop augmented reality applications. The functionality of the augmented reality is demonstrated by using mobile camera. To create an application, beside Unity as a basic tool, another tool for easier development of augmented reality applications is required. In our case, we have chosen Google ARCore.

The main idea of this augmented reality application is for a certain image to be recognized by the mobile phone and then a 3D model to be shown on top of that images. For that purpose, the part of the tool Google ARCore, named AugmentedImages will be used. This feature enables designing of augmented reality applications, which can respond to the 2D images, such as posters and

product boxes. First, a set of reference marker images are initially added, which later will be recognized, when targeted with the camera of the mobile phone.

To use Google ARCore, this tool has to be downloaded and then imported to the Unity project.

Adding the images to the project is simply done by dragging them in the appropriate folder with images, as shown on Fig. 3. Therefore, the images are selected, and a database of images is created. This image database needs to be set as an image source in the configuration folder.

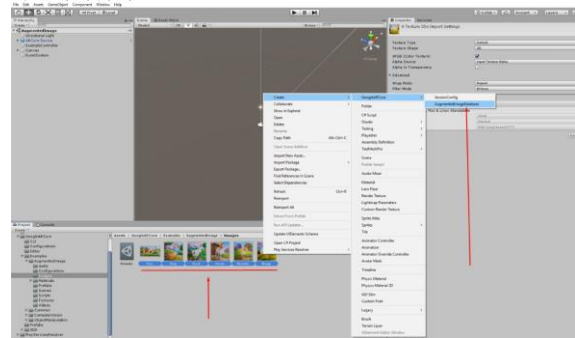

Figure 3. Adding images in Unity.

The 3D models used in this application are downloaded from <https://poly.google.com>. This is a Google folder of 3D models, which can be used to create several different applications, as shown on Fig. 4. Its interface is very useful and easy-to-use.

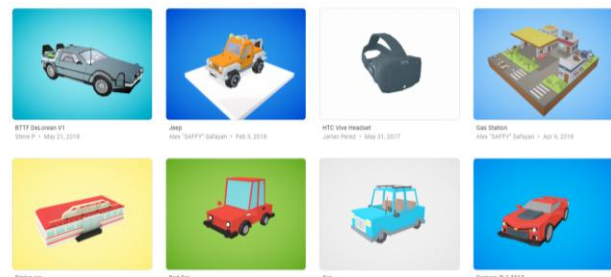

Figure 4. The folder of 3D models on poly.google.com.

With the simple downloading and dragging of the models in the appropriate folder in Unity, they become available for further using in the project. The next step is creating the scene, where selected models will be shown, after their successfully recognition from the device, as shown in Fig.5.

The adequate audio file is added to the previously created scene. The sounds will be played when the right model will be shown on the scene.

To connect all previous parts, and make them as one scenario, a short C# script in C# has to be written. This script enables adequate showing and hiding of the learning subject, depending on recognized image in the real world. For that purpose, the scene is connected to a

corresponding script. In that script, all elements (e. g. models and sounds) as objects are added, in order to perform action on them, through the adequate code. The script is consisted of two parts. The references to the used objects and performed action are located in the first part. The update methods, which Unity uses to create a new frame on the screen of the device are in the second part [11].



Figure 5. Adding 3D models in Unity.

The adequate audio file is added to the previously created scene. The sounds will be played when the right model will be shown on the scene.

To connect all previous parts, and make them as one scenario, a short C# script in C# has to be written. This script enables adequate showing and hiding of the learning subject, depending on recognized image in the real world. For that purpose, the scene is connected to a corresponding script. In that script, all elements (e. g. models and sounds) as objects are added, in order to perform action on them, through the adequate code. The script is consisted of two parts. The references to the used objects and performed action are located in the first part. The update methods, which Unity uses to create a new frame on the screen of the device are in the second part [11].

The control script code is quite simple and understandable. Its purpose is to check which image is recognized and based on that, to show the adequate model in the scene. Initially, all models are hidden, and all the sounds are muted. When an image is recognized, a model for that image's index is shown and the adequate sound is played.

The next script is for getting the information about the recognized image, from another script, initially added by Google ARCore. This script checks on every frame, if on the device's screen any of the reference images is shown, and whether the application is running. If any of the images from the database is recognized, the control script is activated and the appropriate image variable is placed on the found image [4] [11].

Fig. 6 and Fig. 7 show a part of developed augmented reality application, when different models are used: a car and an animal, respectively.



Figure 6. Showing the functionality of the created application - a car.



Figure 7. Showing the functionality of the created application - an animal (horse).

## V. CONCLUSION AND FURTHER WORK

The technology of augmented reality is opening new opportunities for development numerous applications that will be used on daily base in many areas of the contemporary life. The intention of created application is to help the pupils at school in their everyday classes to learn more information about animals and things that they usually encounter [5].

This application and the augmented reality technology will be very useful in the process of educating young students and pupils at school. The application and the technology of augmented reality will improve the quality of the teaching materials through fun and interactive learning. In the future, every school should have augmented reality equipment and to use augmented and virtual reality tools to create teaching materials. This can be achieved by supplying the schools with suitable devices such as smartphones, tablets and glasses [5] [9].

In the near future, more efforts should be made toward development of wide range of applications in the field of education and their usability, because augmented reality offers great opportunities to support learning and teaching process.

As further work, we will extend this educational application to cover more teaching contents and to put appropriate score points to measure learning achievement results and to validate this digital game-based learning application.

REFERENCES

- [1] <https://www.infoq.com/articles/augmented-reality-best-skds/>.
- [2] K. Babilinski, J. Linowes, "Augmented Reality for Developers", by Packt Publishing, October 2017
- [3] Jesse Glover, "Unity 2018 Augmented Reality Projects: Build Four Immersive and Fun AR Applications Using ARKit, ARCore, and Vuforia" by Packt Publishing, Birmingham, UK, July 2018
- [4] M. Lanham, "Learn ARCore — Fundamentals of Google ARCore: Learn to build augmented reality apps for Android, Unity, and the web with Google ARCore 1.0", Packt Publishing, March, 2018.
- [5] Helen Papagiannis, Augmented Human: How Technology Is Shaping the New Reality, by O'Reilly Media, August 2017
- [6] Jens Grubert & Dr. Raphael Grasset, "Augmented Reality for Android Application Development", by Packt Publishing, November 2013
- [7] Kipper, Greg, and Joseph Rampolla. Augmented Reality: an emerging technologies guide to AR. Elsevier, 2012.
- [8] J. Glover, J. Linowes, Complete Virtual Reality and Augmented Reality Development with Unity: Leverage the power of Unity and become a pro at creating mixed reality applications, Packt Publishing, April 2019.
- [9] Dieter Schmalstieg, Tobias Hollerer, Augmented Reality: Principles and Practice (Usability), Addison-Wesley Professional, June 2016.
- [10] Jimmy Alamparambil, Jonathan Ogle-Barrington, Eric Van der Kerckhove, Matt Larson, Unity AR & VR by Tutorials (First Edition), Razeware LLC, 2019.
- [11] Joe Hocking, "Unity in Action: Multiplatform Game Development in C# with Unity 5".
- [12] Saidin, Nor Farhah, Noor Dayana Abd Halim, and Noraffandy Yahaya. "A review of research on augmented reality in education: advantages and applications." *International education studies* 8, no. 13 (2015): 1-8.
- [13] Akçayır, Murat, and Gökçe Akçayır. "Advantages and challenges associated with augmented reality for education: A systematic review of the literature." *Educational Research Review* 20 (2017): 1-11.
- [14] Martín-Gutiérrez, Jorge, Peña Fabiani, Wanda Benesova, María Dolores Meneses, and Carlos E. Mora. "Augmented reality to promote collaborative and autonomous learning in higher education." *Computers in human behavior* 51 (2015): 752-761.
- [15] Sanna, Andrea, and Federico Manuri. "A survey on applications of augmented reality." *Advances in Computer Science: an International Journal* 5, no. 1 (2016): 18-27.
- [16] Nguyen, Vinh T., and Tommy Dang. "Setting up virtual reality and augmented reality learning environment in Unity." In *2017 IEEE International Symposium on Mixed and Augmented Reality (ISMAR-Adjunct)*, pp. 315-320. IEEE, 2017.
- [17] Hwang, Gwo-Jen, Po-Han Wu, Chi-Chang Chen, and Nien-Ting Tu. "Effects of an augmented reality-based educational game on students' learning achievements and attitudes in real-world observations." *Interactive Learning Environments* 24, no. 8 (2016): 1895-1906.
- [18] Cabero Almenara, Julio, and Julio Barroso. "The educational possibilities of Augmented Reality." (2016).
- [19] Katiyar, Anuroop, Karan Kalra, and Chetan Garg. "Marker based augmented reality." *Advances in Computer Science and Information Technology (ACSIT)* 2, no. 5 (2015): 441-445.
- [20] Van Eck, Richard. "Digital game-based learning: It's not just the digital natives who are restless." *EDUCAUSE review* 41, no. 2 (2006): 16.
- [21] Dută, Mihaela, Corneliu I. Amariei, Crenguta M. Bogdan, Dorin M. Popovici, Nicolae Ionescu, and Cristina I. Nuca. "An overview of virtual and augmented reality in dental education." *Oral Health Dent Manag* 10 (2011): 42-49.
- [22] Yuen, Steve Chi-Yin, Gallayanee Yaoyuneyong, and Erik Johnson. "Augmented reality: An overview and five directions for AR in education." *Journal of Educational Technology Development and Exchange (JETDE)* 4, no. 1 (2011): 11.
- [23] Jamali, SitiSalmi, Mohd Fairuz Shiratuddin, and KokWai Wong. "An overview of mobile-augmented reality in higher education." *International Journal on Recent Trends In Engineering & Technology* 11, no. 1 (2014): 229-238.

# Data Processing within Ambient Assisted Living System

A. Dimitrievski\*, S. Savoska\*\*, I. Chorbev\*, B. Ristevski\*\* and V. Trajkovik\*

\*Faculty of Computer Science and Engineering, University "Ss. Cyril and Methodius", Skopje, Republic of North Macedonia

\*\* Faculty of Information and Communication Technologies, "St. Kliment Ohridski" University-Bitola, Republic of North Macedonia

{snezana.savoska, blagoj.ristevski}@fikt.edu.mk, {ivan.chorbev, vladimir.trajkovik}@finki.ukim.mk

**Abstract - The increased aging population, especially in Europe, together with the increasing financial expenses of providing medical care, create the need for novel systems to provide self-care and home-care. The rapid progress of mobile technologies, sensors, Internet of things, cloud and fog computing, provides the necessary infrastructure for such systems to be developed. This work describes a data processing within an ambient assisted living system. The data processing include data from both environmental sensors and body sensors, capable of following activities and taking care of humans living in a specific healthcare environment.**

## I. INTRODUCTION

Ambient Assisted Living (AAL) has the ambitious goal of improving the quality of life and maintaining the independence of people (elderly, home-care patients) through the use of technology [1]. AAL can improve the quality of life by reducing the need for caretakers, personal nursing services, or the transfer to nursing homes. In this context, there are two goals: a social advantage (a better quality of life) and an economic advantage (a cost reduction for society and public health systems). So, it causes that the size of EU AAL market was 186 m Euro in 2017 and prediction for 2021 is to grow at 1.384m Euro [2]. But, the penetration of AAL technology is not as it expected, (0.3 - 0.7 %) with tendency to increases until 2021 (1.3 – 1.8 %).

AAL covers wide range of activities with creating care models and algorithms, enabling technologies and assistive solutions, monitoring of elderly people vital signs, home rehabilitation, ICT solutions connected with AAL, people with chronic conditions, wider population including the peoples with different impairments, robotic assistance for the elderly, sensing technologies for AAL, measurements devices and sensors connected according to Internet of Things and smart housing in general context [3]. Most efforts towards building AAL Systems are based on developing pervasive devices and use of Ambient Intelligence to integrate these devices to construct an environment appropriate to the user [4]. Technology influences the ability to express the power of a human being and the importance of social connections [5]. In this context, the usage of advanced information and communication technologies (social networks) could help connect people and organize community activities.

AAL systems need to ensure high-quality-of-service. Essential requirements of AAL systems are usability, reliability, data accuracy, cost, security, and privacy. According to [6], in order to achieve these requirements, it is essential to involve citizens, caregivers, industry, researchers, and governmental organizations in the development cycle of AAL systems, so that end-users can benefit more from the collaborative efforts.

As the research in AAL matures, data generated from AAL Internet of Things devices will benefit from the analysis by well-established machine learning techniques. There is also potential that new research in machine learning and artificial intelligence can be used on data generated from the sensors used in AAL [7].

The electronic health record (EHR) is a collection of electronic health information about an individual patient and a portion of the population, operated by institutions and healthcare holders. It is a mechanism for integrating health care information currently collected in both paper and electronic medical records (EMR) or Electronic Health Record (EHR) to improve quality of care [8]. A personal health record (PHR) is a health record where the patient himself maintains health data and information related to the care of a patient. PHR provides a complete and accurate summary of an individual's medical history which is accessible online, under strictly defined access permissions. One of the advantages of novel AAL systems is integrating data from AAL systems and smart homes with data from EHR or PHR. Although it is still in an early stage, aggregating data from different medical devices and integrating them with data from health records enable a comprehensive view of health data [9]. Presenting these health data can lead to more efficient and informed decisions by physicians, nurses, patients, and informal caregivers [10].

AAL is seen as a promising alternative to the current care models and consequently has attracted much attention. According to [11], there are three categories of AAL interoperability services: 1) notification and alarming services, 2) health services, and 3) voice and video communication services. A convenient way to integrate EHRs, PHRs, AAL, home care, and self-care systems is the approach of integrating them in a highly connected, robust, and reliable cloud platform, offering uninterrupted availability.

In this context, it is important to distinguish different groups of stakeholders. The AAL Association categorizes users into three groups:

- Primary users – senior citizens or disabled people who have AAL solutions installed at home,
- Secondary users - informal caregivers (such as family members and friends), companies, and organizations that are using AAL solutions for the benefit of end-users.
- Tertiary users - institutions and organizations (such as public sector, health, and insurance organizations) who are not in direct contact with AAL solutions but play a role in providing or financing them.

## II. SMART HOME-BASED HEALTH MONITORING SYSTEMS

Smart home and health monitoring systems integrate different home appliances sensors from different health monitoring devices in order to gather data and create knowledge for its end users. The knowledge can be taken into consideration by medical practitioners for a different recommendation or additional information if they can access them. Some researcher state that it can be connected with patient's PHR and made available for usage [12].

In [13], a general architecture for AAL based on mobile and web technologies is presented. Mobile devices are used for collecting data from environmental and body network sensors, but also for easy access to specific personal data. Raw data is preprocessed, filtered by noise, and then processed using healthcare algorithms that transform raw data into relevant information which is distributed and used by different services. This model includes the processing of data aggregated from social networks needed to give different recommendations to the users and medical centers along with data collected by sensors.

Many researchers pointed out of specific usage of AAL based mobile applications in specific medical domain as cardiovascular diseases [14] taking into consideration quality characteristic of service [15].

“Smart Monitor” [16] is an AAL system based on video capturing and face recognition. AAL systems can be used in different medical health care centers, but they can also be used for home automation. This system belongs to a category of intelligent AAL systems because it can be configured to react on specific objects in movement, but also can automatically detect, track and recognize objects of interest and react on specific events without a qualified employee for monitoring and reporting. Different environmental sensors and cheap cameras enable this system to monitor a variety of activities at the premises

---

The work described here is partially supported by the project “Intelligent Medical Services”, financed by Faculty of Computer Science and Engineering, Ss Cyril and Methodius University, Skopje, R.N. Macedonia.

where it is implemented.

Younghwan [17] describes a context-aware smart system for covering more significant areas. This system is mainly used for the prevention of crimes and different accidents. It is composed of two parts: a sensor network and a data processing server. An aggregator sensor network is built with cheap sensors connected and positioned in different locations. Different types of sensors used, generate very complex raw data. Data is processed by a data fusion server that processes the data using different algorithms and generates data in different formats. Similar system developed by Wood at alias described in [18].

## III. DATA SOURCES IN AAL SYSTEMS

Body sensor networks (BSN) are types of wireless sensor networks (WSN) composed of sensors attached to the human body. The primary purpose of BSN is to measure the physiological signals and to provide information about human behavior. Therefore, the number, the type, and the characteristics of the sensors mainly depend on the application and system infrastructure [19]. Two types of sensors could be applied: one capable of collecting continuous time-varying signals such as accelerometers, pedometers, gyroscopes, electroencephalography (EEG) sensors, electromyography (EMG) sensors, visual sensors, auditory sensors and others to collect discrete time-varying signals such as glucose sensors, temperature sensors, humidity sensors, blood pressure sensors. State-of-the-art sensors nowadays have high compact factor and are thus easily wearable with high biocompatibility. Wireless communication technologies such as Bluetooth or Zigbee, radio frequency identification devices (RFID), and Ultra-Wideband (UWB) could be employed to transmit the collected data.

The environmental sensors are reading the values of the user's environmental parameters. Moreover, the sensor technology can be applied to collect environmental information regarding the location of people and objects, information about their interaction, etc. Additionally, by applying data fusion techniques on the data gathered from both BSN and environment sensors, reliable assessments of a person's behavior, and the activities performed could be conducted. From the sensor technologies perspective, AAL applications are facing various challenges, among which, one of the most important ones is the quality of the collected data which is the basis for further behavioral analysis [20].

## IV. DATA PROCESSING IN AAL SYSTEMS

The data preprocessing phase includes checking whether the received data is from the right sensor of a WSN network. The results of this phase are still considered raw sensor data, and the data is sent to the next stages. The next step is data filtering, including noise reduction out of the received signals. Removing the noise present in the signals requires different techniques, depending on their nature. Since there is a possibility of noise, within the proposed system model, caused by the movement of the user, one way to eliminate this type of noise is the use of an adaptive filter. Another approach for

such systems that have a fusion of different sensor data is to use methods and algorithms, including Kalman filter, Bayesian networks, and Dempster-Shafer [21].

The next phase is data verification, including generalization and additional data calculations. This phase of the data processing workflow aims to formalize and give an overview of the real situation of the user. In the case where the results are critical, a message is sent to the responsible medical staff and the user.

Essential aspects in this kind of systems are the timely transmission of data and the type of data that should be transferred, which has a significant role in determining the strategy to be used in case of delay. Based on the nature of the signals, whether it is a continuous transmission or not, they can be divided into:

- Wavy-dependent data requires no continuous data transfer. As a result, the transmission of data can commence only when data is requested from the system or periodic monitoring is scheduled.
- Wavy-independent data requires the continuous transmission of data for long periods, especially in critical and emergencies [22].

The increasing diffusion of home area networks, intended for the delivery of multimedia contents as well as home automation data, is a new challenge for networking, in general, and also for data delivery in AAL systems. Possibly time-critical data transmissions (such as those related to dangerous events or alarms) have to coexist with delay-tolerant ones. However, at present, most of the available domestic and building automation solutions provide ad hoc answers to the market requirements, and their heterogeneousness makes it very hard to organize an integration process, due to the lack of an interoperability-oriented design. Since the convergence of many traditional services over IP-based infrastructures drastically increases the amount of IP data traffic to be delivered to the users, questions about the Quality of Service management arise and must be taken into account.

There are some prominent causes of energy wastage in wireless networks: retransmission of lost packets, reload (overhearing), idle listening and re-broadcast (over emitting). In medical applications, however, recovery of lost packets through retransmission is not necessary, because health data must be in real-time. Any packet loss must be replaced with the latest update on the situation. Retransmission of packets also requires more memory to store nodes, which is usually limited in size.

Data received from the sensors may have been damaged, so the following approaches can be executed: (1) to accept the data, (2) remove and wait for the next load, (3) seek to reload. The selection of the proper strategy depends on the type of the loaded data. If the data is irrelevant or it is a type of data that loads often, then the second option is acceptable. If measurements are for more sensitive data, the third option should be applied.

Energy consumption also needs to be carefully analyzed to make an informed decision. One approach to save energy is the application of an efficient compression scheme. This method achieves a reduction in the amount

of information that will be transmitted [23]. The following algorithms can be used in WSN: Lempel-Ziv 77 (LZ77) and Lempel-Ziv-Welch (LZW) (based on the methods for prediction by partial matching based on statistical methods), while Burrows-Wheeler Transform (BWT) reduces the amount of information and optimizes data compression. Benchmark tests done on these algorithms show that the algorithm LZ77 has maximum speed and minimum memory used [24].

Generally, body sensor networks are reading the value of the user's health parameters. The environmental sensors are reading the value of the user's environmental parameters. Additionally, the user can use applications that can measure (follow) the user's physical activities. All data is gathered by the user's personal or mobile device, for instance, a PC, laptop, tablet, smartphone or smart TV, and along with data from clinical centers, medical databases, and social networks are sent for further processing by assisted healthcare algorithms. The processed data (by assisted healthcare algorithms) are sent back to the end-users in order to provide the wanted services. The logical architecture of a System for Assisted Living is shown in Figure 1.

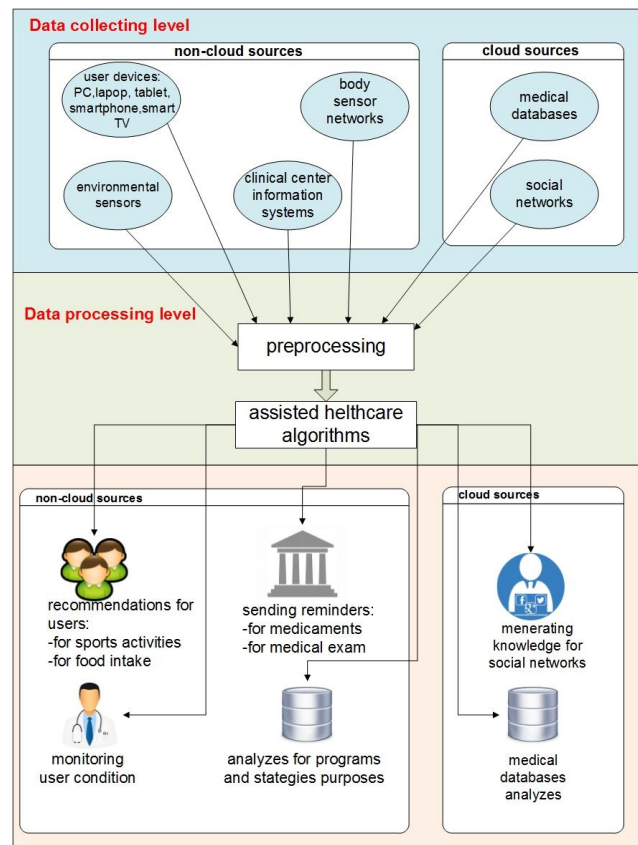

Figure 1. The logical architecture of the System for Assisted Living.

#### A. Security issues

The fundamental goals of secure healthcare systems are safely exchanging the users' information and preventing improper use of illegal devices, such as intercepting transferred data, eavesdropping communications, using out-of-date information, or

revealing the users' medical conditions or other private data. Specific security requirements will have a significant influence on the performance of the system:

Local database in users' devices stores data received by sensors for a limited time. When there are problems in sending the data to a clinical center or social networks, some of the data is not going to be sent. These systems clearly demand high reliability, guaranteed bandwidth, and short delays.

Most patients do not want anyone to know their medical information, except their family doctor or medical specialist. The solutions are to use a cryptographic algorithm to encrypt medical information and protect the necessary data. Only an authenticated entity can access the corresponding data that are available for that entity; unauthenticated entities are denied access when they demand information that they do not have the rights to obtain. For example, asymmetric cryptography (i.e., PKI) is often used, because these private keys are credentials shared only by the communicating parties.

Every user can choose what information can be private or public. User can choose his records to be public: (a) for medical purposes, (b) to all visitors of the social network, (c) to users in his category, (d) to none. In order to have medical support, the user has to agree to share personal information with clinical centers and medical databases, whose data are also protected.

#### *B. Validity of information*

One of the most critical issues in the system is information validity and confirmation. We could divide the system's information validity into three categories.

Most reliable information (valid information) is information that originates from the clinical centers, medical databases, and sensors.

The second category (reliable information) is information generated from social networks. This information can be confirmed (transferred in the first category) if confirmed by the medical records from clinical centers. This confirmation is then applied to data generated by corresponding algorithms implemented in the social networks.

Information from personal profiles (age, weight, height, diagnose entered by end-user) are third category information (unreliable information). Increase of validation of this information can be done by comparing them with average results using social network data or by confirming them with the medical records coming from healthcare institutions.

#### V. CONCLUSIONS

This paper describes how, by combining the processing power, low price, scalability, and reliability of the cloud platforms along with the evermore capable sensor available in smartphones and home environments is a combination we expect to bring forward assisted and enhanced living environments. Transferring the burdening processing of raw sensor data to the cloud and fog enables advanced algorithms to be used while saving

battery power in the sensors and demanding insignificant processing capabilities in client devices. All these advantages are expected to promote this architecture and similar ones into the forefront of ambient assisted living systems.

#### ACKNOWLEDGMENTS

The work described here is partially supported by the project "Intelligent Medical Services", financed by Faculty of Computer Science and Engineering, Ss Cyril and Methodius University, Skopje, R.N. Macedonia.

#### REFERENCES

- [1] Cardinaux, F., Bhowmik, D., Abhayaratne, C., Hawley, M.S.: Video based technology for ambient assisted living: A review of the literature. *J. Ambient Intell. Smart Environ.* 3(3), 253-269 (2011)
- [2] Varnai P. and all, AAL Market and Investment Report: Summary, A study prepared for the AAL Programme by the Technopolis Group, 2018 Ambient Assisted Living Association, Brussels, <http://www.aal-europe.eu/wp-content/uploads/2019/02/Technopolis-AAL-Market-report-SUMMARY-181224.pdf>, Assesses 10.8.2019
- [3] Leone A. and all, Leone A. and all, Ambient Assisted Living, Springer, Italian forum 2018, Springer, doi: <https://doi.org/10.1007/978-3-030-05921-7>
- [4] Memon, M., Wagner, S.R., Pedersen, C.F., Beevi, F.H.A., Hansen, F.O.: Ambient Assisted Living Healthcare Frameworks, Platforms, Standards, and Quality Attributes. *Sensors*. 14, 4312-4341 (2014)
- [5] Kulev, I., Vlahu-Gjorgievska, E., Trajkovik, V. and Koceski, S.: Development of a novel recommendation algorithm for collaborative health: Care system model. *Comput. Sci. Inf. Syst.*, 10(3), pp.1455-1471 (2013)
- [6] Sun, H., De Florio, V., Gui, N., Blondia, C.: Promises and challenges of ambient assisted living Systems. In: Proc. of International Conference on In-formation Technology: New Generations (ITNG), pp. 1201 –1207 (2009)
- [7] Dimitrievski, A., Zdravevski E., Lameski, P., and Trajkovik V. :A survey of Ambient Assisted Living systems: Challenges and opportunities. In 2016 IEEE 12th International Conference on Intelligent Computer Communication and Processing (ICCP), pp. 49-53. (2016)
- [8] Roehrs A. and all, Personal Health Records: A Systematic Literature Review, *Journal of Medical Internet Research*, 2017; 19(1):e13, doi:10.2196/jmir.5876
- [9] Knaup, P., Schöpe, L.: Using Data from Ambient Assisted Living and Smart Homes in Electronic Health Records, *Methods InfMed.* 53, pp.149–151 (2014)
- [10] Lameski, P., Zdravevski, E., Koceski, S., Kulakov, A., & Trajkovik, V.: Suppression of intensive care unit false alarms based on the arterial blood pressure signal. *IEEE Access*, 5, pp. 5829-5836. (2017)
- [11] Mikalsen, M., Hanke, S., Fuxreiter, T., Walderhaug, S., Wienhofen, L.: Interoperability Services in the MPOWER Ambient Assisted Living Platform. In: Medical Informatics Europe (MIE) Conference 2009, Sarajevo, August 30 - September 2 (2009)
- [12] Berlo A. and all (Editors), Ambient Intelligence – Software and Applications, 4th International Symposium on Ambient Intelligence (ISAml 2013), Springer (2013)
- [13] Trajkovik, V., Vlahu-Gjorgievska, E., Koceski, S., Kulev, I.: General Assisted Living System Architecture Model, Mobile Networks and Management Lecture Notes of the Institute for Computer Sciences, Social Informatics and Telecommunications Engineering Volume 141, pp 329-343, (2015)
- [14] Chaudhry M.S. Sarwar, Muthiah Vaduganathan, Stefan D., Anker, Stefano Coiro, Lampros Papadimitriou, Joel Saltz, Elinor R. Schoenfeld, Richard, L. Clark, Wilfried Dinh, Frank Kramer,

- Mihai Gheorghiane, Gregg C. Fonarow, Javed, Butler, Mobile health applications in cardiovascular research. *Ijca* (2017), doi:10.1016/j.ijcard.2018.06.039
- [15] Omerovik A. and all, Elicitation of Quality Characteristics for AAL Systems and Services, in BerloA.and all (Editors), *Ambient Intelligence – Software and Applications*, 4th International Symposium on Ambient Intelligence (ISAmI 2013), Springer (2013), pp.95-104
- [16] Frejlchowski, D., Gościewska, K., Forczmański, P., Hofman, R.: “SmartMonitor” — An Intelligent Security System for the Protection of Individuals and Small Properties with the Possibility of Home Automation, *Sensors* 14, pp. 9922-9948, (2014)
- [17] Oh, Y.: “Context Awareness of Smart Space for Life Safety”, (2015), <https://pdfs.semanticscholar.org/717a/47de9257140d8eb941a74ac15f7037931b61.pdf>, Accessed 10.5.2019
- [18] Wood, A., Stankovic, J., Virone, G., Selavo, L., He, Z., Cao, Q., Doan, T., Wu, Y., Fang, L., Stoleru, R.: B, Context-aware wireless sensor networks for assisted living and residential monitoring. *IEEE Network* 22(4), pp. 26–33 (2008).
- [19] Liolios, C., Doukas, C., Fourlas, G., Maglogiannis, I.: An Overview of Body Sensor Networks in Enabling Pervasive Healthcare and Assistive Environments. In: Proceedings of the 3rd International Conference on Pervasive Technologies Related to Assistive Environments, Samos, Greece, 23–25 June (2010)
- [20] Nugent, C.D., Galway, L., Chen, L., Donnelly, M.P., McClean, S.I., Zhang, S., Scotney, B.W., Parr, G.: Managing Sensor Data in Ambient Assisted Living. *JCSE* 5(3), pp. 237-245, (2011)
- [21] Mohammad, S., Mohebbi, N.: A Comparative Study of Different Kalman Filtering Methods in Multi Sensor Data Fusion. In: Proc. of the International Multi-Conference of Engineers and Computer Scientists, vol.I IMECS , 18 – 20March, Hong Kong, (2009)
- [22] Andrey, B.: PhD - Context Reasoning, Context Prediction and Proactive Adaption in Pervasive Computing Systems Andrey. Department of Computer Science, Electrical and Space Engineering, Luleå University of Technology, Sweden, (2011)
- [23] Di Francesco, M., Das, S.K., Anastasi, G.: Data Collection in Wireless Sensor Networks with Mobile Elements: A Survey. *ACM Trans. Sen. Netw.* 8(1) Art 7 (2011)
- [24] Barr, K.C., Asanović, K.: Energy-aware lossless data compression. *ACM Transactions on Computer Systems* 24(3), pp. 250–291 (2006)



# Web Content Accessibility for People with Cognitive Disabilities

N. Blazheska-Tabakovska, S. Savoska, B. Ristevski, I. Jolevski and D. Gruevski

Faculty of Information and Communication Technologies – Bitola

“St. Kliment Ohridski” University - Bitola

Ul. Partizanska bb. 7000 Bitola, Republic of North Macedonia

natasa.tabakovska@fikt.edu.mk, snezana.savoska@fikt.edu.mk, blagoj.ristevski@fikt.edu.mk,

ilija.jolevski@fikt.edu.mk, dragan.grueski@fikt.edu.mk

**Abstract** - Web accessibility is considered as a component of universal design, the purpose of which is to lower the discrimination level in access to the living environment for people with special needs. People with cognitive disabilities are impaired in the act of processing information such as well as remembering or reasoning, making it more difficult for them to process information in a recognized, meaningful way. This paper gives an overview of the ways of inclusion of people with cognitive disabilities in the world wide web with systematic approach regarding all aspects of design and publishing of web content. The WCAG 2.0 standards with success criteria from Level AA and Level AAA are explored in order to enable access to information and knowledge through Internet for people with cognitive disabilities.

**Keywords:** web content, e-learning content, cognitive disabilities, web accessibility

## I. INTRODUCTION

One responsibility of every society is to create an environment that provides equal access to all aspects of life for everyone, including formal and informal education. The ambition to fully include people with disabilities in the society is manifested in the UN-declaration of human rights and in the international and national legislations[1]. Full and equal access to the Internet's World Wide Web is an enabler of other basic human and civil rights [20].

Recently, the old-fashioned education process and process of gaining information and knowledge has been abandoned. The evolution of technology played a key role in this development. Nowadays the education is easier and the same applies to providing individualized information anytime, anywhere and on any device [9-10].

More specifically, web and e-Learning platforms thoroughly have changed the process of gaining information, knowledge and the learning process. The innovative implementations of e-Learning enable students to have access to exercises and can elaborate their assignments online[11]; to learn through game and with the use of smart devices; to gain more motivation in the learning process and to show more interest in learning [12-14]; to acquire knowledge outside the classroom with the help of portable mobile devices [15]. All these activities can be hosted, integrated and provided through

Learning Management Systems[8]. But, people with disabilities don't have the same fundamental rights to access information, knowledge and services, including the Internet, as others in the society. People with disabilities are faced with many challenges when using the Internet. Therefore, the access barriers to learning opportunities reinforce the social exclusion of persons with disabilities.

As the web becomes a worldwide standard for communication, learning, entertainment, and exchange of any information, the primary work was focused on the introduction of web accessibility standards for the disabled population.

Nowadays, a respectable progress in public awareness for accessibility on all levels has been achieved. Lots of countries accept the requirements of Online and Communications Council (OCC), all government websites are confirmed by the World Wide Web Consortium (W3C) Web Content Accessibility Guidelines (WCAG 2.0). The W3C Web defines (conceives) web content as “information and sensory experience to be communicated to the user by means of a user agent (e.g., a browser), including code or markup that defines the content's structure, presentation, and interactions” (W3C, 2005). WCAG 2.0 is the world standard for creating accessible web contents. It is classified as the ISO/IEC 40500 standard and contains three implementation levels, ‘A’, ‘AA’ and ‘AAA’.

This paper gives an overview of the ways of inclusion of people with cognitive disabilities in the world wide web. The rest of paper is organized as follows. The second section depicts the different types of disabilities with an emphasis on the cognitive disabilities. In Section 3, we describe the impact of IT applications on accessibility of information and knowledge for people with cognitive impairments. The impact of web accessibility and how WCAG standards are suitable for people with cognitive impairment are tabled in the consequent section. The last section provides concluding remarks about full and equal access to the Internet's World Wide Web for people with cognitive disability.

## II. COGNITIVE DISABILITIES

According to the Disability Services Act (1993), a disability is any continuing condition that restricts everyday activities [2]. The World Health Assembly (WHA) on May 22nd, 2001, approved the International Classification of Functioning, Disability and Health (ICF) which breaks down disability into a number of broad sub-categories, including the following 8 main types of disability: Mobility and physical impairments, Spinal cord disability, Head injuries(TBI)-Brain disability, Vision disability, Hearing disability, Cognitive or Learning disabilities, Psychological disorders and Invisible disabilities. Many people with disabilities have a combination of these impairments. The most common type is physical disability, generally relating to disorders of the musculoskeletal, circulatory, respiratory and nervous systems. Another type of disability is sensory disability which involves impairments in hearing and vision. Neurological and cognitive disabilities include acquired disabilities such as multiple sclerosis or traumatic brain injury. Intellectual disabilities include intellectual and developmental disabilities which relate to difficulties with thought processes, learning, communicating, remembering information and using it appropriately, making judgments and problem solving. Psychiatric disorders resulting in disabilities may include anxiety disorders, phobias or depression. [2]

Cognitive disabilities affect the act of processing information such as well as remembering or reasoning, making it more difficult to process information in a recognized, meaningful way for the individual [16]. Cognitive disabilities include all conditions or impairments that inhibit a person's mental process[17]. According to the Siteimprove team, cognitive disabilities may be classified in two ways, functional (includes: memory, attention, math comprehension, verbal comprehension, visual comprehension, problem solving) and clinical (includes: autism, traumatic brain injury, dementia, developmental disability, dyslexia, dyscalculia and learning disabilities in genera ). In this paper we will be focusing on cognitive disorders from a functional standpoint. More specifically, we will focus on the barriers, and not on the diagnosis,of improving the user's experience.

Recently, there has been a lot of discussions about the diseases of the modern age, which are not classical disabilities such as visual, hearing or motor impairments. The cognitive disabilities are increasingly prevalent especially among children and young people. For example, the US National Survey of Children's Health (NSCH) highlighted the increasing trend on the prevalence of diagnosed of autism spectrum disorder (ASD) in the United States and globally within the last 30 to 40 years.

A conducted survey shows that in 2014 an average of 1 in every 59 (1.7%) 8-year-old children were

identified as having ASD [3]; in the year 2018 an average of 1 in every 40 children had a diagnosis of autism spectrum disorder[4]. Also, the University of Michigan has estimated that between 5-10% of the population has dyslexia, but this percentage can also be even higher than 17%. The symptoms of dyslexia range from mild to severe.

The diversity of abilities and experiences of users with cognitive disabilities can indicate to problems [19]. The wide range of cognitive disabilities and their effects on users, make an already complex issue even worse. So, finding a prescriptive solution for cognitive accessibility seems almost impossible – there is no rubric that covers even the basics [18]. However, many experts offer suggestions for making websites easier to use for users with cognitive disabilities. Many of these experts' recommendations are basic usability principles.

## III. ACCOMMODATING COGNITIVE DISABILITIES WITH IT

Some people with disabilities use assistive technologies (AT) such as screen magnifiers, text-to-speech, keyboards instead of mice or any another assistive device for web surfing, to help them access information. Computer code allows AT software to convert content to speech for screen reading functions and audio information to text for captioning. People with cognitive disabilities benefit from these same mechanical and verbatim translations. They profit from conversions that format text to audio and the reverse, as well as from the opportunity to use content presented in multiple communication modalities and to alter the viewing format of the information presented[21].

Children and students with ASD use augmented reality systems for improving their social skills. This technology offers additional visualization for learning or playing, combines virtual objects generated by a computer, with a real environment [22]. The promising advanced technologies - 3D holograms can also help children with ASD for academic learning [23].

The learning management systems, such as ones compatible with life-long training and ones allowing people to gain new skills and knowledge, provide great opportunities for creating learning environments for people with disabilities, notably those with cognitive impairments and limited learning activities. These systems offer the flexibility so that the people with disabilities can adapt their training program to meet their specific needs. Choosing the most suitable LMS for people with cognitive disability is very important. Over the past few years, commercial LMS vendors, and open-source communities have invested significant resources into making their products more accessible. At the same time, accessibility still remains a challenge for users with disabilities as well as elderly people.[5]

The comparative analysis made about different levels of compliance according to the Guidelines for WCAG 2.0 standards shows ATutor as an e-learning platform outperforms other platforms that are considered in the analysis. ATutor have better features compared with the others LMSs in part of: User Interface takes into consideration navigation and forms; Personalization and Customization; Common Modules/ Tools - Accessibility feature; Authoring Tools/ Content Creation and Help and Documentation [6]

For contents on many websites and applications, today it is an imperative to be compliant with the WCAG 2.0 standard. Listed in the implementation Level AAA are the success criteria that are arguably the most significant for cognitive-specific support mechanisms.

Dr Scott Hollier [16] has emphasizes that in relation to cognitive disabilities specifically, the WCAG 2.0 standard includes some requirements such as: providing captions in online video which provides both audio and visual reinforcement of spoken dialogue; creating content that can be presented in different ways; giving users enough time to read and use the content; making text readable and understandable, ensuring that the language of a page is clearly defined and easy to read; helping users avoid and correct mistakes, especially around inputting information into forms and clear guidance on how to fix mistakes etc. The application of these criteria makes web content more appropriate for people with cognitive impairments.

#### IV. COGNITIVE DISABILITIES AND WEB ACCESSIBILITY

An accessibility encompasses all disabilities that affect access to the Web, including visual, auditory, physical, speech, cognitive, and neurological disabilities. (W3C).

People with disabilities are faced with many challenges when access to information and knowledge through Internet. The way that can facilitate this activity is the dedication to web accessibility in the web design process and/or in the e-learning content design process. When we are talking about web site accessibility or e-learning content accessibility it means that people with all disabilities (visual, auditory, physical, speech, cognitive, and neurological disabilities) can access information and knowledge through the Internet.

According to Kelly et al. [25] the Web Accessibility Initiative (WAI) has made a significant contribution on raising awareness of the issues of web accessibility, but these guidelines are incompatible for more specific e-learning contents. The author emphasizes that these incompatibilities will be overcome by a wider perspective of accessibility guidelines when it comes to the domain of e-learning.

Creating accessible web sites and applications is more time demanding. It requires technical expertise in web design or e-learning content design and also expertise in accessibility issues. By using the latest web technologies, it is easier to make accessible sites.

However, accessible web sites benefit everyone, not just those with disabilities. On an accessible website, the user is put in the centre of the experience. The design is clean and simple. Text is easy-to-access, more readable, more user-friendly, contents are better organized, optimized for display on different type of device, optimized for search and easier to maintain. [7]

Therefore, the effort is to create universally accessible pages, not alternative accessible versions such as: text be heard instead of seen, audio be read instead of heard, images are described instead of seen, and so on.

In the created web and application contents for people with cognitive disabilities, the following WCAG 2.0 success criteria from Level AA and from Level AAA should be implemented: all live video content should have captions; visual content should also be represented in words; the user should be allowed to take extra time to complete a task if required; if content is flashing, moving or refreshing the user should be able to pause, stop or hide that content; there should be a clear description of the title of a web page or app screen; links should be descriptive and meaningful, avoiding phrases like 'click here' or 'read more'; providing more than one way for people to find content; the language should be clearly defined so that speech recognition software interprets the page correctly; if the language changes, that change should be clearly indicated; words that are not common or considered jargon should be specifically defined such as in a glossary; abbreviations should be clearly defined. Moreover information should be readable at a lower secondary level (this could potentially include a specific sheet written in Easy English); the correct pronunciation should be indicated for difficult words; nothing unexpected should happen when an element receives focus; users should be able to select an option and then confirm that option rather than immediately taking them to their choice; the navigation of the website should be predictable and consistent; language should be used consistently, e.g. not interchanging a full name with an acronym. Additionally, the user should know that an error has occurred; it should be clear what you want the user to enter; guidance should be provided to the user as to how they can fix their error; guidance should be provided on what type of information needs to be entered in the form.

The demands of web accessibility and usability for most people are similar. Web accessibility is considered as a component of universal design, the purpose of which is to lower the discrimination

level in access to the living environment for people with special needs [23]. Usability of web technologies is the availability of effective design of websites and applications [24]. In the paper, we summarize different guidelines and propose four design considerations main areas of the specifics, which should be taken into account when creating a web content, which be used also by the users with cognitive, learning and neurological impairment, as shown on Fig.1.

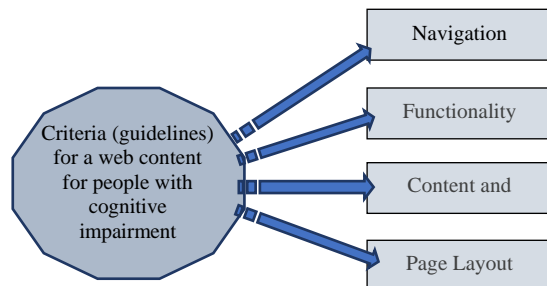

Figure 1. The main guidelines area for a web content for people with cognitive impairment

#### A. Navigation

Creating a user-friendly navigation should be one of the most important things that a professional needs to take into consideration. For people with cognitive disabilities it is of the utmost importance that the navigation is standardized and unambiguous; headings, subheadings, and lists for structuring the information are used; the outline of the context is highlighted; menus are short and easy to understand; limited number of options are used to prevent cognitive overload. Also, for people who use the assistive technologies it is very important that the navigation has various options [26].

#### B. Functionality

The best advice to help users with cognitive disabilities is to provide information in multiple formats, with emphasis on visual formats. Supplemental media such as illustrations, icons, video and audio have the potential to greatly enhance the accessibility of web content for people with cognitive disabilities. But, to be avoid background noises or images that distract and to be avoid advertisement and sponsored links that can defocus attention of user [26].

Options such as: font change and font size; line height change or space between lines of text; increase of the size of "clickable" areas; mouse over highlighting of text for easier reading; change of background color of a page; and color invert and contrast increase of the page will increase web functionality [18].

For this area is important to take into consideration the list of design rules that can be easily turned into general "good design principles" such as: functionalities that are as predictable as possible; providing guidance and help; avoiding complex interactive processes, keeping them simple and brief; the separate task broken up into separate

pages; the steps named; remainders used; error messages explained as much as possible; user actions managed (warning when action is with serious consequences, input mask, possible / impossible actions etc.)

#### C. Content and Text

Short, simple, unambiguous phrases are easier to understand than long, complex, ambiguous ones [26]. Prioritizing information to ensure that all critical material is at the top half of the page, using a lot of white space on the page and offering text with different lands [18]. Avoiding using only one method for present the content. No one method is sufficient by itself. The visual communication methods: image-only representation for the message, or relying completely on graphics, illustrations, and other non-text materials, may not be appropriate for some users. Visual communication methods include colour, relationships, styles, design elements, photos, images, etc. [26].

Avoiding non-literal content such as sarcasm, parody, and metaphors. Also, avoiding a lot of math computation and formulas. Instead of that, explaining math conceptual or performing computation automatically if it is necessary is better [26].

#### D. Page Layout

The layout covers the availability of screen elements, form or announcement. Being consistent with pages, fonts, colors, and locations of page elements as well as providing logical reading order-material is well organized on the webpage, are one of the main principles of inclusion in web accessibility [17]. Streamline page design is very important. It is necessary to use high contrast between text and background. Some time making a page visually interesting it can make a page extremely difficult to read, (graphical spacers and tables can disrupt the reading). For people with cognitive disabilities is not appropriate text that moves or changes when the mouse moves over it and also is recommended reducing clutter and extra material [18].

### V. CONCLUSION

One of the general principles that underlie the Convention on the Rights of Persons with Disabilities is providing access to all aspects for all people on an equal basis. It means "universal design", design usable by all people, to the greatest extent possible, without the need for adaptation or specialized design.

Taking into consideration the trend of increasing rate of people with cognitive disabilities it is necessary more proactive role of the community to facilitate the accessibility of digital assets and web contents. Our research highlighted that implementation of WCAG 2.0 success criteria from Level AA and from Level AAA in the process of

web sites and applications design in the four design considerations main areas: navigation, functionality, content and text and page layout, will increase the web sites accessibilities.

The e-learning and e-health systems have provided a wide range of contents for people with different preferences as well as with different disabilities, so these criteria can meet their needs. A number of automatic validation tools can provide partial accessibility validation. A list of such tools is referenced on the W3C website.

As further work, we will be focusing on implementation of principles in developed e-learning platform as a part of EU and North Macedonia within the IPA project CROSS4ALL (Cross-border initiative for integrated health and social services promoting safe ageing, early prevention and independent living for all), IPA 2 – 2014-2020 (Cross4all-CN1-S01.2-SC015).

#### REFERENCES

- [1] Stefan Johansson, Jan Gulliksen, Ann Lantz, Cognitive accessibility for mentally disabled persons, 15th Human-Computer Interaction (INTERACT), Sep 2015, Bamberg, Germany. pp.418-435, 10.1007/978-3-319-22701-63. hal-01599467
- [2] Government of Western Australia, Department of Communities, Disability Services, <http://www.disability.wa.gov.au/understanding-disability/understanding-disability/what-is-disability/>
- [3] NATIONAL INSTITUTE OF MENTAL HEALTH, AUTISM SPECTRUM DISORDER (ASD), <https://www.nimh.nih.gov/health/statistics/autism-spectrum-disorder-asd.shtml>
- [4] "The Prevalence of Parent-Reported Autism Spectrum Disorder Among U.S. Children" Kogan MD, et al. *Pediatrics*. Nov. 26, 2018, <http://pediatrics.aappublications.org/content/early/2018/11/21/peds.2017-4161>.
- [5] NatashaBlazheska-Tabakovska, BlagojRisteovski, SnezanaSavoska, AndrijanaBocevska, Learning Management Systems as Platforms for Increasing the Digital and Health Literacy, ICEBT2019
- [6] Bocevska, Andrijana, SnezanaSavoska, BlagojRisteovski and NatasaBlazheska-Tabakovska. "Analysis of Accessibility of the e-Learning Platforms According to the WCAG 2.0 Standard Compliance" In Proceedings/8th International conference on applied internet and information technologies, AIIT 2018, pp. 26-31. Bitola, Republic of Macedonia, 2018.
- [7] Better UN websites for everyone, Accessibility guidelines for united nations websites, <https://www.un.org/en/webaccessibility/index.shtml>
- [8] Vassilakis K, Makridis J, Lasithiotakis M. A., Kalogiannakis M, Vidakis N. Facilitating Learning in Isolated Places Through an Autonomous LMS, ICST Institute for Computer Sciences, Social Informatics and Telecommunications Engineering (07 March 2018), book series (LNICST, volume 229)
- [9] Motiwalla, L.F.: Mobile learning: a framework and evaluation. *Comput.Educ.*49(3), 581–596 (2007)CrossRefGoogle Scholar
- [10] Gikas, J., Grant, M.M.: Mobile computing devices in higher education: student perspectives on learning with cellphones, smartphones & social media. *Internet High. Educ.* 19, 18–26 (2013)CrossRefGoogle Scholar
- [11] Dicheva, D., Dichev, C., Angelova, G., Agre, G.: Gamification in education: a systematic mapping study. *Educ. Technol. Soc.* **18**, 75–88 (2015)Google Scholar
- [12] Vidakis, N., Christinaki, E., Serafimidis, I., Triantafyllidis, G.: Combining ludology and narratology in an open authorable framework for educational games for children: the scenario of teaching preschoolers with autism diagnosis. In: Stephanidis, C., Antona, M. (eds.) UAHCI 2014, Part II. LNCS, vol. 8514, pp. 626–636. Springer, Cham (2014). [https://doi.org/10.1007/978-3-319-07440-5\\_57](https://doi.org/10.1007/978-3-319-07440-5_57)Google Scholar
- [13] Vidakis, N., Syntychakis, E., Kalafatis, K., Christinaki, E., Triantafyllidis, G.: Ludic educational game creation tool: teaching schoolers road safety. In: Antona, M., Stephanidis, C. (eds.) UAHCI 2015, Part III. LNCS, vol. 9177, pp. 565–576. Springer, Cham (2015). [https://doi.org/10.1007/978-3-319-20684-4\\_55](https://doi.org/10.1007/978-3-319-20684-4_55)CrossRefGoogle Scholar
- [14.]Groh, F.: Gamification: state of the art definition and utilization. *Res. Trends Media Inf.*14(02), 39–46 (2012)Google Scholar
- [15] Zimmerman, H.T., Land, S.M.: Facilitating place-based learning in outdoor informal environments with mobile computers. *TechTrends* 58(1), 77–83 (2014)CrossRefGoogle Scholar
- [16] Dr Scott Hollier, Cognitive Disability Digital Accessibility Guide, Media Access Australia-Inclusion through technology [www.mediaaccess.org.au](http://www.mediaaccess.org.au), 09.2019
- [17] Siteimprove Cognitive Disabilities and Web Accessibility, 12.2014 (<https://siteimprove.com/en/blog/cognitive-disabilities-and-web-accessibility/>)
- [18] Heather Mariger, Cognitive Disabilities and the Web: Where Accessibility and Usability Meet?, The national center on Disability and access to education, <http://ncdae.org/resources/articles/cognitive/>
- [19] Serra, M. &Muzio, J. (2002). The IT support for acquired brain injury patients: The design and evaluation of a new software package. *Proceedings of the 35th Hawaii International Conference on Systems Sciences – 2002*.
- [20] Wicker, S., &Santoso, S. (2013). Access to the Internet Is a human right, *Communications of the ACM*, 56, 45–46.
- [21] Peter Blanck, eQuality: Web Accessibility by People With Cognitive Disabilities, INCLUSION, 2015, Vol. 3, No. 2, 75–91, DOI: 10.1352/2326-6988-3.2.75
- [22] He, Z., Peng, L., Han, H., Xu, M., Wang, G., Bao, X., Yu, H., Hou, Z., Wang, H., Zhu, L., Zhang, Z.: Design and implementation of augmented reality cloud platform system for 3DEntity objects. In: 8th International Congress of Information and Communication Technology (ICICT-2018). *Procedia Comput. Sci.* 131, 108–115 (2018)
- [23] V. Andrunyk et al. , Information Technologies for Teaching Children with ASD, In book: Advances in Computer Science for Engineering and Education II, pp.523-533, DOI: 10.1007/978-3-030-16621-2\_49
- [24] Dattolo, A., Luccio, F.L.: A review of websites and mobile applications for people with autism spectrum disorders: towards shared guidelines. In: Gaggi, O., Manzoni, P., Palazzi, C., Bujari, A., Marquez-Barja, J. (eds.) *Smart Objects and Technologies for Social Good, GOODTECHS 2016*. Lecture Notes of the Institute for Computer Sciences, Social Informatics and Telecommunications Engineering, vol. 195. Springer, Cham (2017)
- [25] B. Kelly, L. Phipps and E. Swift, "Developing a holistic approach for e-learning accessibility," *Canadian Journal of Learning and Technology*, vol. 30, no. 3, 2004.
- [26]CognitiveDisabilities, <https://webaim.org/articles/cognitive/design>.

# Using Computers as a Learning Tool in English Language Teaching

L.Ivanovska

Faculty of Information and Communication Technologies – Bitola  
“St. Kliment Ohridski” University – Bitola, Republic of North Macedonia  
lela\_bt@yahoo.com

**Abstract-** The popularity of information technology (IT) over the past decade has brought about the innovative use of the Internet in English language learning and teaching process. The Internet has the potential to provide a new learning environment that has rich digital textual, graphic, audio, video and other interactive features for the learning approach as well as for culture. While learning English, computers can support and facilitate the roles of the teacher in order to enhance students' skills to perform well in reading, writing, listening and speaking activities. Using computers and Internet can improve EFL learners' language abilities, and they also reach real learning experiences. In addition, computers contribute beneficially to learners' learning and development. They gain the opportunity to access useful language resources and communicate with native English speakers through computers and Internet. Moreover, students can learn listening, speaking, reading and writing English through real-world situations. In addition, computers are important in language learning because they help students to think critically in their learning process and make them have active and stable knowledge. That is, they are provided with more creative activities through using computers. In this paper we concur with researchers who consider computers as a very innovative and creative tool in teaching language process.

## I. INTRODUCTION

The popularity of information technology (IT) over the past decade has brought about the innovative use of the Internet in English language learning and teaching process. The Internet has the potential to provide a new learning environment that has rich digital textual, graphic, audio, video and other interactive features for the learning approach as well as for culture. [1](2) pointed out that “technology is changing the jobs of language teachers through the changes it prompts in the language itself, the opportunities for studying language, and the options available for teaching language”. Current computer technology provides new opportunities to increase the effectiveness of language learning and teaching especially in the field of teaching and learning foreign languages.[2](3) wrote: There are at least two important aspects of literacy-technology integration: (1) using technology to teach more effectively and enhance the learning of skills and strategies that currently make up a strong reading/language arts curriculum, and (2) effectively teaching and enhancing the learning skills and strategies that

make up the strong reading / language arts curriculum of the future. In this paper we concur with researchers who consider computers as a very innovative and creative tool in teaching language process.

## II. USE OF COMPUTERS IN ENGLISH LANGUAGE TEACHING

Recent years have revealed a growing interest in using computers for language teaching and learning. A decade ago, only a small number of specialists was concerned with the use of computers in the language classroom.[3] However, the role of computers in language instruction has now become an important issue facing large numbers of language teachers throughout the world. For the teachers, the question now is not of whether but how computers can aid in the language learning process [4]. The rapid technological advances of the 1980s and 1990s have raised both the expectations and the demands placed on the computer as a potential learning tool. With recent advances in multimedia technology, computer-assisted language learning (CALL) has emerged as a tempting alternative to earlier modes of supplementing or replacing direct student-teacher interaction, such as the language laboratory or audio-tape-based self-study. Computer-assisted language learning (CALL) came into view in the 1960s [5]. The rapid growth in computer technology and the frequent use of computers among the linguists and literary researchers opened up the way for the introduction of computers in language teaching and learning. In the early stages, CALL, according to [6] was little more than an imitation of older, more familiar media. As put by [7] the tendency was rather to try to push and squeeze current language learning materials to it the computer, to “computerize” our lab exercises, or imitate unabashedly the teaching machines or programmed instruction of the recent past.

Early attempts with computers often emphasized drill-and practice grammar exercises [8] and it was found that students were not very interested in using such software [9]. However, since the mid-1970s, CALL has changed. It has been developed on the context and communication based approaches supported by current educators

[10]. When the goal is communication in language learning, then language drills fit into only a small part of language learning. However, drills are required particularly in the first stages of vocabulary acquisition where giving the same information in multiple modes, such as visual plus aural plus textual, enhances recognition and recall [11]. However, it is still too early to claim that the design and implementation of CALL software has satisfied the needs of the learners and teachers because there are many interrelated factors that have to be considered such as the learning theory and the current approach used in language teaching. [12], ICT usage is classified to tutor, tool and tutee. Tutorial programmes lead learners step-by-step through a programme such as drill and practice. Using technology as a tool can help other types of problems, for example, technology as a tool is frequently seen in tutorial or explanatory programmes [13]. ICT acts as a tutee where students programme the computers in order to gain more understanding. A number of different ICT tools and applications may be integrated in teaching and learning [14]. Some of these tools and applications may be designed specifically for educational purposes and some others for more general use. The choices of resources, and the way they are used, can be linked to different learning theories which may be invoked to explain or predict learning benefits from the use of ICT [15]. Besides, based on [16], computers are seen as a tool which can make "worthwhile contribution to the teaching of English as second language". English language teachers' perception is very vital as it will determine the usage level of ICT in English classes and its impact on the students. The above statement is supported by [17]. as they say that teachers' believe and perception of technology can determine the usage of it in the classroom. Perception is being emphasized because if English teachers have a negative perception on the use of ICT, then the dissemination of computer knowledge and effort of government in encouraging ICT integrated language teaching will be in vain. Therefore English teachers' perception about the usage of ICT in teaching English language is one of the key drivers which will determine the effectiveness of using ICT in English language classes.

### III. PREVIOUS STUDIES ON THE BENEFITS OF COMPUTERS IN IMPROVING LANGUAGE SKILLS

In recent years, language teachers have been exploring ways in which the computer can be employed to make language learning more effective and motivating for students [18]. [19] defined the computer as a catalyst in

motivating teachers and learners to work in new ways. The researcher understood that as learners become more autonomous, teachers feel that they should support their learners to act and think independently.

The application of computer has changed the methods from teacher-centered to learner-centered ones. Teachers should guide their learners' learning and this change is very useful for learners to increase their learning [20]. According to [21] the use of computer increases learners' cooperation in learning tasks. It helps them in gathering information and interacting with resources such as videos.

There are two different views about how to integrate the computer into the class. The first one is the cognitive approach where learners get the opportunity to increase their exposure to language meaningfully and make their own knowledge. The second one, the social approach, where learners must be given opportunities for authentic social interactions to practice real life skills. This objective can be obtained through the collaboration of learners in real activities [22].

The researcher [23] investigated the role of technology in language learning. The results revealed learners' learning was improved by integrating technology into the classroom. Learners stated that the use of computer in school makes learning enjoyable and helps them learn more. Learners also said that technology makes learning interesting and interactive as well as increases their motivation, social interactions, learning and engagement.

[24] performed a study on using technology in improving learners' writing and reading skills. The results of this study indicated that technology tools enhanced learners' reading and writing skills because they are user-friendly, and learners can learn at a more effective way. Also, learners learn more effectively because the Internet provided a favorable learning environment for learners' learning, facilitated a new platform for learners who can have a convenient access to learning lessons.

[25] carried a study on whether Wiki technology would improve learners' writing skills. Learners had a task to join a Wiki page where they would write passages and then read and answer the passages of their fellow classmates. Learners indicated that the immediate feedback they received was a benefit of using this kind of technology. Another finding of this study was that learners learned spelling, vocabulary and sentence structure by reading the work of their classmates.

#### IV. RECOMMENDATION FOR THE SUCCESSFUL INTEGRATION OF TECHNOLOGY

Recommendations for learners to improve their language skills through using computers:

1. Teachers should provide more visually stimulating course material
2. Teachers should attempt to address a wider variety of learning styles
3. Teachers should urge their learners to use technology in developing their language skills
4. Teachers should encourage their learners to use technology in increasing their language abilities
5. Training should be provided for teachers to learn how to use and teach it effectively
6. Universities should regard technology as a significant part of teaching and learning programs
7. In order to facilitate the integration of technology, enough support and technical assistance should be provided for teachers

#### V. CONCLUSION

In this paper, the literature review indicated that computers can improve EFL learners' language abilities, and reach real learning experiences. In addition, computers contribute beneficially to learners' learning and development. They gain the opportunity to access useful language resources and communicate with native English speakers through computers and Internet. Moreover, students can learn listening, speaking, reading and writing English through real-world situations.

In addition, computers are important in language learning because they help students to think critically in their learning process and make them have active and stable knowledge. That is, they are provided with more creative activities through using computers. To sum up, the findings of this literature review showed that technology provides more visually stimulating course material, attempts to address a wider variety of learning styles, helps learners to develop thinking skills, promotes learners' autonomy, and increases learners' motivation to effectively learn a foreign language.

#### REFERENCES

- [1] Chapelle, C. (2008). Computer Assisted Language Learning. In B. Spolsky & F. Hult (eds.). *The Handbook of Educational Linguistics*. Malden, MA: Blackwell.
- [2] Akinwamide, T.K. (2007). *Enhancing Teaching and Learning of English Using New Technologies in Second Language Environment*. Cambridge: Cambridge University Press.
- [3] Warschauer, M. (1996). Computer-assisted language learning: An introduction. In S. Fotos (Ed.), *Multimedia Learning Teaching* (pp.3-20). Tokyo: Logos International.
- [4] Hubbard, P. (2009). General introduction. In P. Hubbard (Ed.), *Computer-assisted language learning: Critical concepts in linguistics: Vol. 1. Foundations of CALL*, (pp. 1-20), Oxon, England: Routledge.
- [5] Wyatt, D. 1984. *Computers and ESL*. Orlando, FL: Harcourt Brace Jovanovich
- [6] Coughlin, J.M. (1989). Recent developments in interactive and communicative CALL: Hypermedia and "intelligent" systems, Washington, DC: Centre for Applied Linguistics (*ERIC Document reproduction No. Ed 313 909*).
- [7] Underwood, M. (1989). *Teaching Listening*. London: Longman.
- [8] Bennett, D., Culp, K. M., Honey, M., Tally, B., & Spielvogel, B. (2000). It all depends: Strategies for designing technologies for educational change. *Paper presented at the International Conference on Learning Technology, Philadelphia, PA*.
- [9] Costley, K. C. (2014). *The positive effects of technology on teaching and student learning*. Arkansas Tech University.
- [10] Coughlin, J.M. (1989). Recent developments in interactive and communicative CALL: Hypermedia and "intelligent" systems, Washington, DC: Centre for Applied Linguistics (*ERIC Document reproduction No. Ed 313 909*).
- [11] Warschauer, M. (2000). The death of cyberspace and the rebirth of CALL. *English Teachers Journal*, October, 61-67.
- [12] Taylor, R. P. (1980). *The computer in school: Tutor, tool, tutee*. New York: Teacher College Press.
- [13] Means, B. (1994). Introduction: Using technology to advance education goals. In B. Means (Ed.), *Technology and Education Reform: The Reality Behind the Promise*. California: Jossey-Bass Inc.
- [14] Eastment, D. (1999). *The Internet and ELT*. Oxford: Summertown Publishing.
- [15] Levy, M. (1997). *Computer assisted language learning: Context and conceptualization*. New York: Cambridge University Press.
- [16] Wyatt, D. 1984. *Computers and ESL*. Orlando, FL: Harcourt Brace Jovanovich.
- [17] Eady, M. J., & Lockyer, L. (2013). *Tools for learning: technology and teaching strategies: Learning to teach in the primary school*. Queensland University of Technology, Australia. pp. 71-89. <https://scholars.uow.edu.au/display/publication76376>
- [18] Levy, M. (1997). *Computer assisted language learning: Context and conceptualization*. New York: Cambridge University Press.
- [19] Hennessy, S. (2005). *Emerging teacher strategies for supporting*. Cambridge, UK: University of Cambridge.
- [20] Li, H. C. (2010). Using podcasts for learning English: perceptions of Hong Kong Secondary 6 ESL students. *Début: The Undergraduate Journal of Languages, Linguistics and Area Studies*, 1(2), 78-90.
- [21] Gillespie, H. (2006). *Unlocking learning and teaching with ICT: Identifying and overcoming barriers*. London: David Fulton. <https://trove.nla.gov.au/work/20064464>.
- [22] Warschauer, M. (2000). The death of cyberspace and the rebirth of CALL. *English Teachers Journal*, October, 61-67.



- [23] Baytak, A., Tarman, B., & Ayas, C. (2011). Experiencing technology integration in education: children's perceptions. *International Electronic Journal of Elementary Education*, 3(2), 139-151. <https://www.iejee.com/index.php/IEJEE/article/view/233>.
- [24] Peregoy, S., & Boyle, O. (2012). *Reading, writing and learning in ESL: A resource book for teachers*. New York: Allyn & Bacon.
- [25] Lin, W., & Yang, S. (2011). Exploring students' perceptions of integrating Wiki technology and peer feedback into English writing courses. *English Teaching: Practice and Critique*, 10(2), 88-103. <https://eric.ed.gov/?id=EJ944900>

# Marker-Based Mobile Augmented Reality for Application of Visualization in Product Packaging

A.Bocevska\*, Z. Kotevski\*, N. Rendevski\* and B. Ristevski\*

\* Faculty of Information and Communication Technologies, Bitola,  
“St. Kliment Ohridski” University – Bitola, Republic of North Macedonia  
Republic of North Macedonia

{andrijana.bocevska, zoran.kotevski, nikola.rendevski, blagoj.ristevski}@fikt.edu.mk

**Abstract - Mobile Augmented Reality has emerged as the most popular and most convenient form of Augmented Reality [AR], especially because mobile devices are enhanced with more sensors, powerful embedded cameras and increased processing power and features. It combines the intelligent display, registration tracking, virtual and reality convergence, and human-computer interactions through portable devices or intelligent terminals. This paper introduces an Android application that can help everyone with application of visualization in product packaging. The idea is to allow the user to view the virtual object in the real world using image targets. This application was developed using following technologies: Vuforia AR, SolidWorks for 3D modeling and Unity3D. The Vuforia AR Extension for Unity enables vision detection and tracking functionality within Unity and allows developers to create AR applications. Unity3D is a cross-platform which comes with an integrated 3D game engine. It can superpose the virtual onto reality and realizes human-computer interaction. SolidWorks software was used for design of a 3D model.**

## I. INTRODUCTION

As computers increase in power and decrease in size, new mobile, wearable, and widespread computing applications are rapidly becoming feasible, providing people access to online resources always and everywhere. This new flexibility provides new kind of applications that exploit the person's surrounding context. Augmented Reality (AR) can be defined as ability to deal with new information immediately direct or indirect therefore influence the physical real-world environment that can be enhanced/augmented by adding virtual computer-generated information to it [1][2]. Basically, AR generates user selected images, videos, 3D objects and information into the real environment which can be viewed through the camera of the devices. AR application are classified into two types: the marker based that uses camera and visible indication to serve as a target, while markerless deals with mobiles global positioning system and compass from the positioning information. Most markers are black and white, although they can be colored, but contrast between colors can be properly recognized by a camera. Simple AR markers are consisted of one or more basic shapes

made up of black squares on white background [3]. Mobile AR applies this concept in truly mobile settings, thereby combining several technologies: global tracking technologies, wireless communication, location-based computing (LBC) and services (LBS) and wearable computing. By considering the definitions from various researchers [4] [5] [6], can be determined that mobile AR: combines real and virtual objects in a real environment, is interactive in real time, registers and aligns real and virtual objects with each other, and runs and/or displays the augmented view on a mobile device. This allows the 3D virtual object to be fully rendered and superimposed on the captured scene, so a user can see it from each side. One of the widely used approaches in the development of AR mobile applications is the use of visual markers. Visual markers used in AR applications allow users to “animate” information associated with markers. Applications that use markers allow user to read information about a specific object or its location using mobile devices. There are many software available in the market to ease application process. The paper is the presentation of application development using new version of Unity3D which comes with Vuforia plugin. The main objective of Vuforia is to move the augmented applications into the Reality using the camera of mobile devices. This software uses the capability of Computer Vision Technology to recognize and track individual coordinates of images. The application can be deployed directly to mobile device for Android platform.

## II. RELATED WORKS

The number of applications utilizing mobile AR is increasing continuously and the outcomes are clear in many domains. This section concerns a summary about prior researches that exploit the mobile AR applications. Reference [7] researches the application of Unity3D the integrated game development tool of multiple platforms and employs the mobile device augmentation of the real application software development kit developed by Qualcomm. A mobile AR application to support musical learning of children is presented in [8]. The application works by verifying whether sequences of musical notes of the melody are

correctly colored in a printed pentagram (target). Reference [9] describes AR and Unity3D, how it applies to learning and training and the potential impact on the future of education. The idea is to allow the user to view the virtual object in the real world using an Object based AR system. A concept of using the technology of AR in education field is proposed in [10]. The users will be able to visually interpret the conceptual diagrams, 3D models, videos, etc. related to the concepts in the book content via an Android application supported by the Android smart phones. This is developed using a game engine called Unity3D, with Vuforia Software Development Kit (SDK) for Unity. Reference [11] describes the procedure to develop an AR application with Unity3D and Vuforia SDK and publish it to a smartphone for the localization of critical tissues or organs that cannot be seen easily by the naked eye during surgery. An interesting way to guide students to use such kits by introducing AR as an interactive user manual, thereby increase students' interest and ease learning and reduce work load of laboratory instructors is proposed in [12]. They have developed the application for the laboratory work of an entire course of Analog and Digital Communications in Unity3D using Vuforia AR SDK. In [13] an objective to develop an AR platform for inspection and maintenance to assist technician and evaluate the effectiveness of implementing AR compared to traditional manual sheets inspection that are currently being used is presented. They used CATIA software for design 3D under hood area parts and Vuforia Unity3D for AR application development. Reference [14] discusses the development of "ARCampusGo" which is a Mobile AR based application intended to improvise the visuals rendered to the user. The informational and navigational requirements are sufficed with the help of Unity3D platform and Vuforia Cloud Services.

### III. EXAMPLE TOOLS FOR AR DEVELOPMENT-VUFORIA AND UNITY3D

Vuforia is an advanced AR building engine that provides an intuitive platform for creating AR applications for Android and iOS platforms. Vuforia features broad functionality and compatibility with other tools. Since many AR applications include the appearance of virtual 3D objects over the real world, building such applications requires a 3D design tool where such objects called 3D models can be created. The top of the rating of such tools is occupied by Unity3D, a powerful game engine allowing building 2D and 3D scenes, games and simulations. Vuforia and Unity3D have been used together to create AR applications. Unity3D offers built-in support of Vuforia allowing creating AR projects easier.

AR can be developed using Vuforia and Unity3D so that Vuforia provides the printable image targets that will trigger the appearance of 3D objects created in Unity3D, or specify the object that the application should recognize to produce AR content. Common uses of Image Targets include recognizing and augmenting printed media and product packaging for marketing campaigns, gaming, and visualizing products in the environment where the product was intended to be used. Vuforia account and a Unity ID are required when creating a project [15]. Vuforia also requires each application to have a unique license key. The license key can be created by logging in to the Vuforia Developer Portal [16], where a unique key will be generated, "Fig. 1". This completes the configuration of project. If all components have been installed correctly, the video feed from web camera will be played.

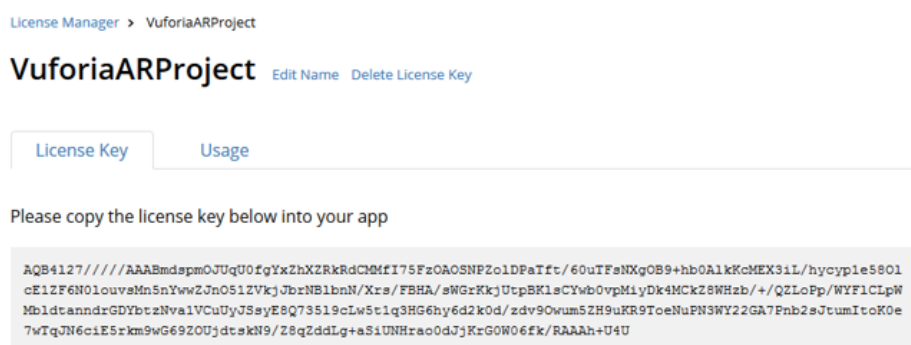

Figure 1. License key by logging in to the Vuforia Developer Portal

### IV. THE PROCESS OF AR DEVELOPMENT WITH VUFORIA AND UNITY3D TOOLS

This section briefly describes the process to use Vuforia and Unity3D to develop Android AR.

#### *Configuring image targets*

To build AR applications, it is necessary to activate the AR camera using GameObject→Vuforia Engine→AR Camera. Image targets trigger the appearance of virtual

objects in an AR app. The corresponding target should be specified so that the application recognizes it. Vuforia Developer Portal and Target Manager page are implemented to set up the image targets. Add Database button is used to proceed to the Create Database page where target image database can be set up, while Add target button, "Fig. 2" to find and select the target images. Vuforia supports four types of targets – Single Image, Cuboid, Cylinder, and 3D Object (we choose Single Image target). Vuforia adds the star rating that shows how easy it will be for the camera to recognize image. Aim for

5 stars. Database can be used in Unity3D after downloading and selecting Unity Editor as the development platform.

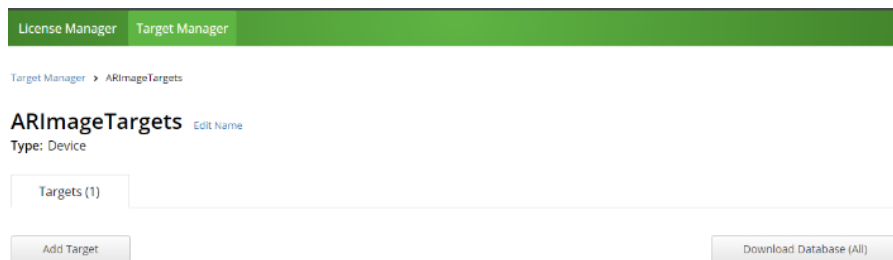

Figure 2. Target button to find and select the target images

### *Adding image targets and 3D objects*

Image Targets represent images that Vuforia Engine can detect and track. Unlike traditional fiducial markers, data matrix codes, and QR codes, Image Targets do not need special black and white regions or codes to be recognized. The Engine detects and tracks the features that are naturally found in the image itself by comparing these natural features against a known target resource database. Once the Image Target is detected, Vuforia Engine will track the image as long as it is at least partially in the camera's field of view.

Image targets can be created with the Vuforia Target Manager using JPG or PNG images in RGB or grayscale. The size of the input images must be 2 MB or less. Features extracted from these images are stored in a database, which can then be downloaded and packaged together with the application. The database can then be used by Vuforia Engine for runtime comparisons. To add an Image Target to the Scene, it should be selected with Vuforia → Image from the menu GameObject. The image target appears on your Hierarchy screen and can be used to connect to the 3D object. Then the type of object that would like to appear in your AR application needs to be selected, "Fig. 3".

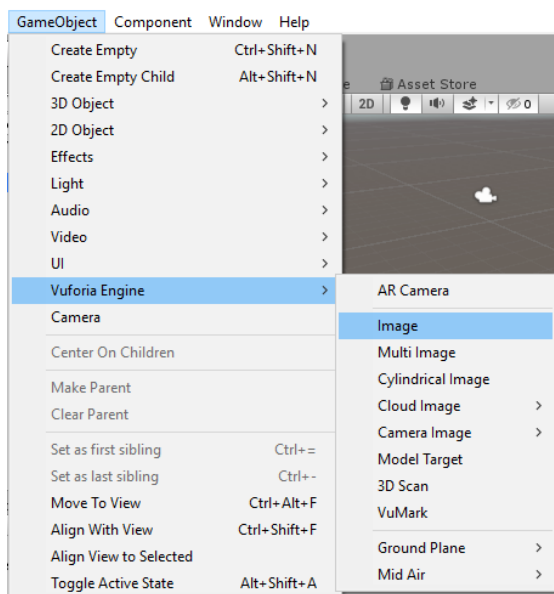

Figure 3. Adding image targets

Digital content to augment target can be added by simply adding assets as children of the target in the scene hierarchy, "Fig. 4". Parenting content with a target object automatically sets up the necessary rendering and physics behaviors. It is used Asset → Import New Asset for this purpose. Unity can work with 3D models of any shape that can be created with modeling software. There are also number of primitive object types that can be created directly within Unity. Unity can read .fbx, .dae (Collada), .3ds, .dxf, and .obj files. Exported files from 3D modeling software in generic formats can be imported and edited by a wide variety of different software. Model files can contain a variety of data, such as character and terrain Meshes, Animation Rigs and Clips, as well as Materials and Textures. In this case 3D model is created using SolidWorks software and imported as fbx file.

Vuforia Engine provides a simulator in the Game view that can be activated by pressing the Play button. This feature can be used to evaluate and rapidly prototype scene(s) without having to deploy to a device.

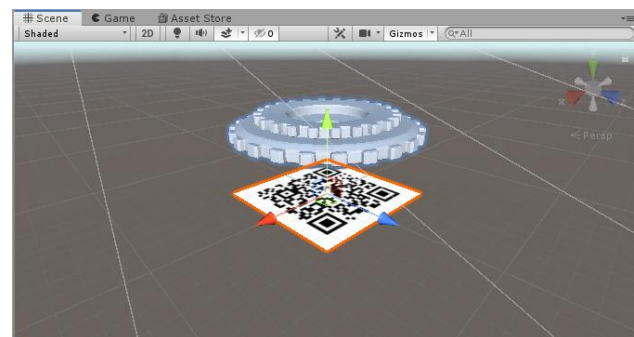

Figure 4. Adding image targets and 3D objects

### *Building the Application*

After developing the application in Unity, it is necessary to choose File → Build Settings, switch platform to Android, and then click Build to export the application as an APK file. This APK file can then be installed on an Android phone, "Fig. 5".



Figure 5. AR model imposed over image target

## V. USING MOBILE AR IN PRODUCT PACKAGING

In order to use installed APK file on an Android phone it is necessary to print image target and place it on the package. This allows the user to visualize the 3D model in the real world using image target without opening the package, "Fig. 6". Respectively, the companies that produce the model can use it as a 3D model for creating application in Vuforia and Unity3D and thus provide three-dimensional visualization using mobile phone.



Figure 6. Mobile AR for visualization in product packaging

## VI. CONCLUSION

This paper emphasizes the creation of interactive mobile AR application for Android mobile devices intended for visualization in product packaging. It uses Unity3D technology and Vuforia as an AR SDK. Based on this, the three-dimensional model created by SolidWorks of scene is simulated by the means of Unity3D. The Vuforia engine using computer vision technology detects and tracks identification features and fabricates corresponding 3D model in accordance with the relative position and attitude information of identifiers on

the visual plane. The real-time synchronization satisfies the users in the real world and enables to feel the virtual space, thus strengthening the space and interaction. Vuforia supports four types of targets – Single Image, Cuboid, Cylinder, and 3D Object (we choose Single Image target). Vuforia also has a built-in star rating that it gives to markers. Our marker scored 5 stars out of 5. If rating is less than 5 stars, it may be harder for the camera to track it. In the future our intended work includes application of visualization in assembly packaging with built-in animations.

## REFERENCES

- [1] J. Carmigniani, B. Furht, M. Anisetti, P. Ceravolo, E. Damiani and M. Ivkovic, "Augmented Reality Technologies, Systems and Applications," *Multimedia Tools and Applications*, Vol. 51, No. 1, 2011, pp. 341-377.
- [2] J. Carmigniani and B. Furht, "Augmented Reality: An Overview" In: J. Carmigniani and B. Furht, Eds., *Handbook of Augmented Reality*, Springer, New York, 2011, pp. 3-46.
- [3] K. Anuroop, K. Kalra, and C. Garg. "Marker based augmented reality." *Advances in Computer Science and Information Technology (ACSIT) 2*, no. 5 (2015): 441-445.
- [4] P. Renevier and L. Nigay, "Mobile collaborative Augmented Reality: the Augmented stroll," in *Proceedings of EHCI, 2001*, pp. 299-316.
- [5] R. T. Azuma, Y. Baillot, and R. Behringer, "Recent advances in Augmented Reality," *IEEE Computer Graphics & Applications*, pp. 34-47, 2001.
- [6] R. T. Azuma, "A survey of Augmented Reality," *Presence: Teleoper. Virtual Environ.*, vol. 6, no. 4, pp. 355-385, Aug. 1997.
- [7] L. Xinqi, S. Young-Ho, P. Dong-Won, "Application Development with Augmented Reality Technique using Unity3D and Vuforia", *International Journal of Applied Engineering Research ISSN 0973-4562 Volume 13, Number 21 (2018) pp. 15068-15071* © Research India Publications.
- [8] B. Lemos, A. G. D. Corrêa., M. Nascimento, R. D. Lopes, "Augmented Reality Musical App to Support Children's Musical Education", *Computer Science and Information Technology 5(4)*: 121-127, 2017.
- [9] D. R. Dhotre, "Research on Object Based Augmented Reality Using Unity3d in Education System", *IJARIE-ISSN(O)-2395-4396, Vol-2 Issue-3 2016*, pp.4481-4492.
- [10] S. Manikandan, N. R. Sarabesh, "Smart books using Augmented Reality", *International Journal of Trendy Research in Engineering and Technology (IJTRET) Volume 1 Issue 1 Aug- 2017*, pp. 18-21.
- [11] D. Lee, J. W. Yi, J. Hong, Y. J. Chai, H. C. Kim, H. J. Kong, "Augmented Reality to Localize Individual Organ in Surgical Procedure", *Health Inform Res.* 2018 Oct;24(4): 394-401. English, © 2018 The Korean Society of Medical Informatics, Published online Oct 31, 2018.
- [12] S. Baloch, S. Qadeer, K. Memon, "Augmented Reality, a Tool to Enhance Conceptual Understanding for Engineering Students", *International Journal of Electrical Engineering & Emerging Technology*, Vol. 01, No. 01, DEC 2018, pp 41-48.
- [13] F. A. Aziz, E. Alostad, S. Sulaiman, K. A. Ahmad, "Augmented Reality Marker Based to Aid Inspection and Maintenance Process in Automotive Industry", *International Journal of Engineering and Advanced Technology (JEAT) ISSN: 2249 - 8958, Volume-8, Issue-3S, February 2019*, pp. 417-421.
- [14] D. Pawade, A. Sakhapara, M. Mundhe, A. Kamath, D. Dave, "Augmented Reality Based Campus Guide Application Using Feature Points Object Detection", *IJ. Information Technology and Computer Science*, 2018, 5, 76-85.
- [15] <https://unity.com/>
- [16] <https://developer.vuforia.com/vui/develop/licenses>

# Impact of Subsidies on Tourism through Analysis of Data Series on Arrived Tourists from Different Emission Zones

C. Andreeski\* and M. Blazhekovikj - Toshevski\*\*

\*Faculty of Tourism and Hospitality – Ohrid, "St. Kliment Ohridski" University, Bitola, Republic of North Macedonia

\*\*Faculty of Information and Communication Technologies- Bitola, "St. Kliment Ohridski University", Bitola, Republic of North Macedonia

cvetko.andreeski@yahoo.com, marina.blazekovic@yahoo.com

**Abstract - In order to make appropriate decisions by the responsible persons it is necessary to have a good analysis of the measures taken in a particular sector, as well as the results of those measures after a certain time limit. By researching the time series of the results of the taken measures can be concluded whether a particular product is in development, stagnation or saturation.**

**Measuring the products can be done by using engineering methods that are used in analyzing technical systems. For this purpose, are used appropriate functions to check the stage for particular emission zone.**

**Keywords: subsidies, functions, analysis**

## I. INTRODUCTION

The subsidization of the number of tourists that arriving in the Republic of Macedonia starts in 2011, with a decision of the Government of the Republic of Macedonia to subsidize charter flights from Benelux countries through the tour operators Corendon and TUI. For each incoming tourist who will be accommodated in a categorized facility with a stay of at least three nights brought by organized charter flight, the Government of the Republic of Macedonia pays EUR 65 subsidy. That measure, with the measure to open commercial airline services through the low-cost airline Wizzair, was the basis for encouraging and developing tourism in the Republic of Macedonia by subsidizing the inflow of foreign tourists in an organized manner. These measures were amended in 2013, 2014, 2015 and 2016 by amending the Rulebooks on the manner, type and amount of subsidies (Official Gazette of the Republic of Macedonia No. 53/13, 147/14, 50/15 and 32/16) [10]. It is evident that there has been an increase in the number of foreign tourists in the Republic of Macedonia in this period, but whether these measures have yielded the expected result of attracting foreign tourists from the desired destinations or are there any other parameters that affect the arrival of foreign tourists? That is what we analyze in this paper. For this purpose, data from the

State Statistical Office's website are taken for foreign tourists arriving by country of origin by year and analyzes the 2010-2018 period (according to available data) for certain emission zones that are important for the development of tourism in the Republic of Macedonia. Were analyzed the emission zones from which came the largest number of tourists as a: Turkey, the Netherlands, Poland, Belgium, but also the zones for which was paid the highest amount of subsidies. This paper analyzes the time series, based on their shape and function, which can be determine which emission zones are on the rise, stagnant, and developing. The analysis is performed using the least squares method with predefined functions for development, stagnation and saturation. Matlab, Simulink and Excel software tools were used as tools for the analysis and presentation of results. The results of this research will enable those responsible for the development of incentives for tourism development to make appropriate decisions. The paper includes: Research methodology, analysis of data from secondary sources, conclusions.

## II. LITERATURE REVIEW

Business data analysis i.e. analyzing a large amount of data from which has obtain relevant information for good decision making is a field of research that has attracted much attention in recent decades. In the paper Zinovy et al. [11] the authors review the skills analysis that individuals should have to do business data and data science research. Their idea is to create curricula for studying these research techniques in order to get more researchers in the field in order to do more quality research in the field, get results and make good decisions. In the paper Hiba A., Mohammed A., Issa S., Samah A., (2017) the authors review the importance of big data research for good decision making [12]. They review some aspects of big data research and their impact on the performance of organizations using this type of research. There are papers in the scientific literature that exploring the application of big data analysis in tourism. In the paper Siyang Q., Jie M., Xuzhao W., Can Li, Honghui D.,

and Xinquan G. (2019), the authors analyze the pressure on infrastructure arising from the high attendance of Beijing during the tourist season [13]. The authors of the paper Marianna S., Roya R., Mike T., (2019) have covered various aspects of the application of big data analysis, ranging from data acquisition to development of smart tourism destinations through the use of Internet of Things - IoT, big data on online agencies and reservation systems as well as measuring tourism development using this type of analysis [14]. This paper will analyze the development of tourism in the Republic of Macedonia by testing the series on the number of tourists from countries for which subsidies have been determined. The data analyzed are taken from the Makstat database which is the official database of the Statistical Office of the Republic of Macedonia. They are structured data, and access to them is through the selection of various parameters that are important for our analysis.

### III. RESEARCH METHODOLOGY

The methodology of emission zone research is simple. We take the annual data of the emission zone to be analyzed, after that identified by a particular function and on the basis of which function gives the least error in identification, we determine the kind of condition for selected emission zone. Similar research can be found in other papers in the field of tourism, as David B., (2006) [6]. We basically use two functions: a linear curve and a saturation curve. The linear function is used to test whether the state of the emissive zone is increasing or stagnant, and the saturation curve indicates whether the emissive zone is in the state of saturation. The slope parameter in the linear function shows whether there is an increase or a stagnation.

Saturation curve can be described according Ikeya (1993) by an exponential function given by 1 [9]:

$$C_T = C_s(1 - e^{-\gamma T N}) \quad [1]$$

Where  $C_s$  is the parameter that gives the amplitude of the curve,  $\gamma T$  is the coefficient of curvature of the curve that depends on the year of calculation of the value of the arriving tourists, and  $N$  is the value that used to bring the series of values in the range 0-1 to get the curve on saturation for any series.  $N$  is the reciprocal value of the maximum value that the function should receive. This function is used to investigate saturation in many areas of human work Ikeya (1993), Allard T., Balan E., Calas G., (2013) [9], [2].

The graph of the curve is given in Figure 1.

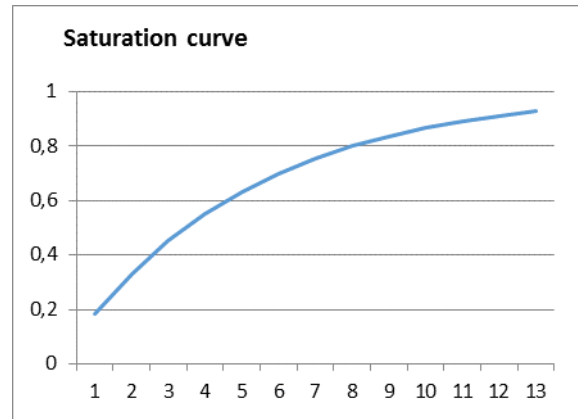

Figure 1. Saturation curve where the horizontal axis gives the years, and the vertical values of the incoming tourists.

Years can also be distributed over longer distances of the curve where the coefficient  $\gamma$  will have a different value. In that case the curve may look as in the Figure 2.

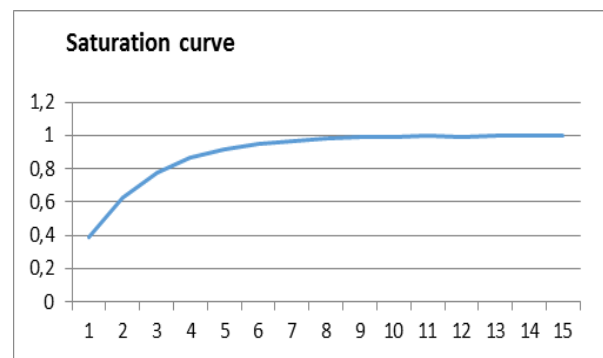

Figure 2. Saturation curve with higher value of coefficient  $\gamma$

For series that are approximated with linear function, the analysis is easier. Depending on whether the function has or does not have a trend, it can be concluded whether the emission zone is growing or stagnating. For linear function we basically use [2] or its simplified version [3].

$$y = \frac{y_2 - y_1}{x_2 - x_1} (x - x_1) + y_1 \quad [2]$$

$$y = ax + b \quad [3]$$

### IV. DATA ANALYSIS RESULTS

For the purpose of this paper, are taken data from the Statistical Office of the Republic of Macedonia for four countries for which are paid subsidies: the Netherlands, Belgium, Turkey and Poland. The Netherlands is the first emission zone for which the Republic of Macedonia has approved subsidies for arrived tourists.

If are seen only the values of foreign tourists arriving in the Republic of Macedonia, then the increase is evident throughout the research period - Figure 3.

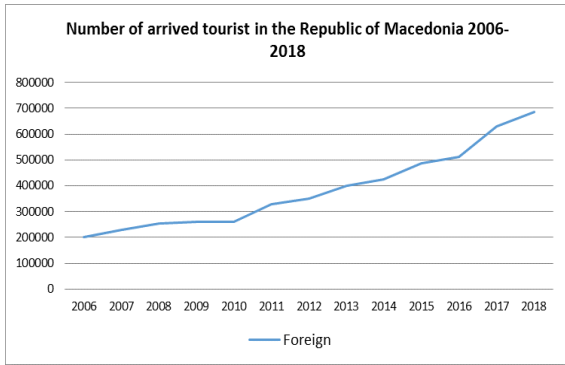

Figure 3. Total number of foreign tourists in the Republic of Macedonia 2006-2018

From the presented data it can be noted that since 2011, when the first subsidized flights for tourism development were introduced, the increase in the number of foreign tourists has been evident. That year is a year of structural change in tourism development, just as 2016 when was adopted the last Rulebook on Subsidizing Foreign Tourists.

The first series that will be analyze is the series of arrived foreign tourists from the Netherlands. This series is graphically shown on Figure 4.



Figure 4. Total number of f Netherlands Netherlands

The figure shows a large jump from 2010 to 2011, which is repeated with less intensity in 2012, after which there is a movement of the series around a certain average value of about 25,000 arriving tourists. Therefore, this series, according to the graph, is a saturated series, because in the last six analyzed years there is no evident increase in the number of tourists arriving. Figure 5 shows the series along with the approximation made with a saturation curve. The optimum values of the curve are obtained by the least squares method.

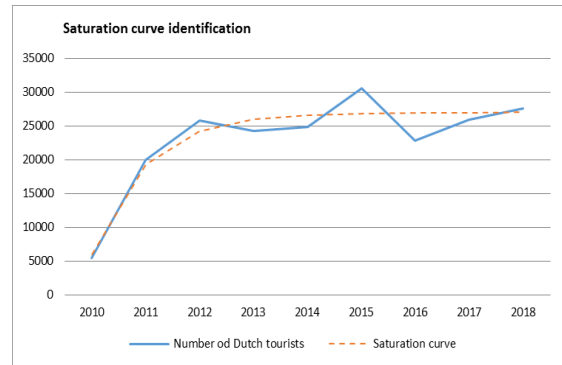

Figure 5. Series of arrived Netherlands tourists with approximation made with saturation curve

For the series the coefficient values are: product  $\gamma TON = 0.25$  and is increased for one each year,  $Cs = 27000$ . With these values, the approximation error is smaller than the given series values. If the same curve would be approximated by a linear function the error is significantly greater. Therefore, can be concluded that this series is saturated and that no expected further significant growth.

The next analyzed emission zone is Turkey. In the last years, most of the tourists come from this emission zone. The graph series is shown on Figure 6.

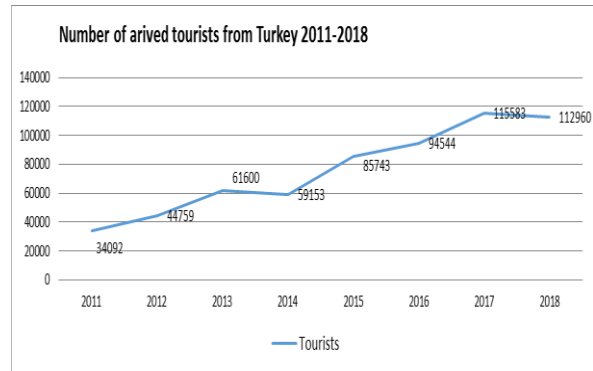

Figure 6. Total number of foreign tourists from Turkey to the Republic of Macedonia 2011-2018

If the largest number of tourists arriving from the Netherlands is around 30 000 in 2015, in the last two analyzed years more than 100000 tourists have arrived from Turkey. This emission zone is very important for tourism development in the Republic of Macedonia. From the shape of the series can be notice a pronounced trend and an almost linear increase in values. Therefore, this series will be approximate with linear function. The graph of the linear approximation is given in Figure 7.



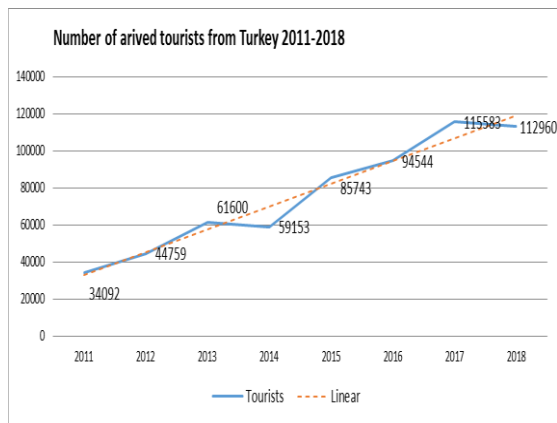

Figure 7 Total number of foreign tourists from Turkey 2011-2018

The last analyzed series is a series of tourists arriving from Belgium. The graph of the series is on Figure 9.

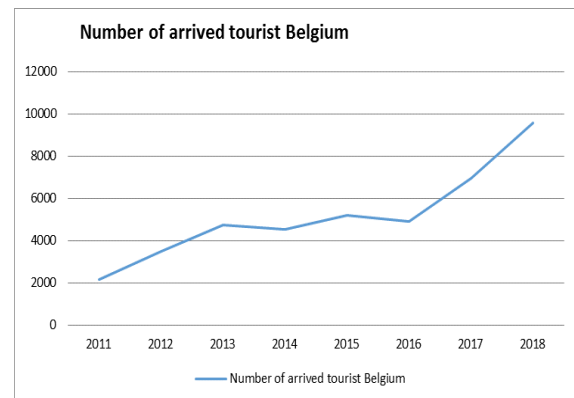

Figure 9. Total number of foreign tourists from Belgium

During this approximation the values of the parameters are:  $a = 12264,286$  and  $b = -24\ 630\ 379$

The parameter  $a$  is positive and indicating an upward trend, and the percentage increase in the analyzed period is greater than 330% and indicating a developmental emission zone.

The next series that is the subject of analysis in this paper is the series of arrived tourists from Poland. The graph of this series is given in Figure 8.

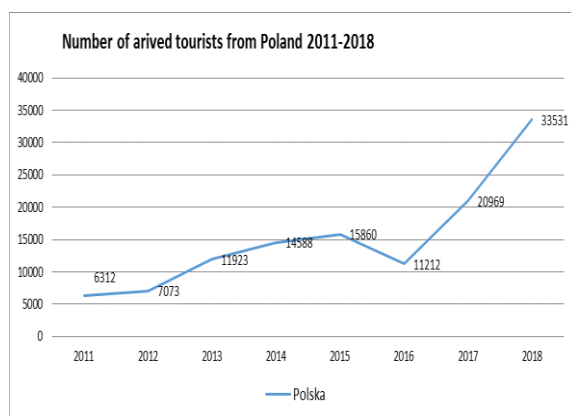

Figure 8. Total number of foreign tourists from Poland 2011-2018

There are two segments in this series: one is until 2016 and the second is from 2016 to 2018. The change in the series is due to the introduction of charter flights from two cities in Poland: Katowice in 2017 and Warsaw in 2018 by Polish tour operator Rainbow [15].

The two segments of the series represent two linear functions with different inclinations and it is evident that after 2016 the increase in the number of Polish tourists that arrived in the Republic of Macedonia is significantly increasing. From 2016 to 2018 there is an almost linear increase with the same slope. For this series, not has identification with linear function due to the structural change and the small amount of data from that change.

The situation with the increase in the number of tourists that arriving from Belgium is similar with the tourists from Poland. And the reasons are the same. In 2016, one of Europe's largest tour operators, Thomas Cook, begins to bring tourists from Belgium organized by charter flights. That is why there is a structural change in the series and a significant increase in the number of arrivals is evident. The first jump of the series is due to the introduction of a direct airline from the Netherlands and through that line come a number of Belgian tourists.

## V. CONCLUSIONS

Like other products and emission zones in tourism have lifespan that should be monitored by analysts and tourism decision makers. Particularly important is the allocation of subsidies to get the best results for the subsidies that are given. Those emerging emission zones that are in grow should be stimulated to attract as many tourists as possible in the future. The emission zones that are in the saturation phase should be considered whether their subsidy is economically viable or should these funds be directed to other emission zones that would result in a better result. Although the period of tourism development in the Republic of Macedonia is not long after independence, it can be noted that some traditional emission zones which have been the impetus for tourism development have already reached the saturation stage, and other emission zones such as Turkey should be subsidized and should be monitoring their development. Those emission zones that have structural change with the introduction of low cost airlines and charter flights should also be subsidized in order to exploit the potential they offer. This paper covers time series for the three different types of functions that offer a response which time series is related to a particular emission zone. Based on such analysis, but also on the number of tourists coming from those emission zones, can be made real decisions for optimal tourism development at the

destination. Of course, this should correspond to the capacity to accommodate tourists as well as the rest of the road and other infrastructure.

#### REFERENCES

- [1] Aguilo, E., Alegre, J., and Sard, M. (2005). The persistence of the sun and sand tourism model. *Tourism Management*. 26(2), pp.219-231.
- [2] ALLARD T, BALAN E., CALAS G., 2013. RADIATION EFFECTS ON CLAY MINERALS, ELSEVIER VOLUME 5, 2013, PP 127-138
- [3] Baldigara, T., & Mamula, M. (2015). MODELLING INTERNATIONAL TOURISM DEMAND. *Tourism and Hospitality Management*, Vol. 21, No. 1., 19-31
- [4] Chen, K. (2011). Combining linear and nonlinear model in forecasting tourism demand. In *Expert Systems with Applications* (pp. 10368-10376). Vol. 38.
- [5] Cvetko A., Daniela M., Modelling and Forecasting Seasonal Time Series in Tourism, Case study for Republic of Macedonia, ETAI Conference, Struga, 2018
- [6] David B., (2006) TOURIST AREA LIFE CYCLE STAGE AND THE IMPACT OF A CRISIS, *ASEAN Journal on Hospitality and Tourism*, Vol. 4, pp. 139-150
- [7] Donald G., Stephen P., (2016). Progress and prospects for event tourism research, *Tourism Management* Vol. 52, February 2016, Pages 593-631
- [8] Hovinen, G.R. (2002). Revisiting the destination lifecycle model. *Annals of Tourism Research*. 29(1), pp. 209-230.
- [9] Ikeya, M., 1993. *New Applications of Electron Spin Resonance: Dating Dosimetry and Microscopy*. World Scientific, Singapore, New Jersey, London, Hong Kong, 500 pp.
- [10] Official Gazzete of Republic of Macedonia No. 53/13, 147/14, 50/15 и 32/16
- [11] Zinovy R., Vishwanath H., Anuja A., Uma U. (2018) Skills Requirements of Business Data Analytics and Data Science Jobs: A Comparative Analysis, *Journal of Supply Chain and Operations Management*, Volume 16, Number 1
- [12] Hiba A., Mohammed A., Issa S., Samah A., (2017) The Impact of Big Data Analytics on Business Competitiveness Proceedings of the New Trends in Information Technology
- [13] Siyang Q., Jie M., Xuzhao W., Can Li, Honghui D., and Xinquan G. (2019) Applying Big Data Analytics to Monitor Tourist Flow for the Scenic Area Operation Management, *Discrete Dynamics in Nature and Society*, Volume 2019, Article ID 8239047, 11 pages
- [14] Marianna S., Roya R., Mike T., (2019) *Big Data and Innovation in Tourism, Travel, and Hospitality*, Springer
- [15] Airport "Sv Apostol Pavle", <http://ohd.airports.com.mk/default.aspx?ItemID=444&id=239>

# Automatic Labeling of Topic Models Using Deep Learning

E. Balci\*, C. Felix\*\* and E. Bertini\*\*

\*The University at Buffalo, USA

\*\*VIDA Lab, NYU Tandon School of Engineering, USA

efecan.balci@nyu.edu, cristian.felix@nyu.edu, enrico.bertini@nyu.edu

**Abstract** - In this project, we propose the use of text generation neural networks as a way to label topics based not only on the keywords but also using the content of the documents associated with the topic. We use an encoder-decoder architecture where first the encoder receives as input the keywords and a sample of the documents and outputs a context vector that will be an intermediate representation of the “meaning” for the topic. The decoder receives this context vector and generates a label for the topic one word at a time. The model is trained using a mix of datasets including Wikipedia and news datasets, where the goal is to generate the title of the article given the article content and a set of keywords. We implement the model using Keras API with Tensor flow as the backend for both, training and prediction steps. The architecture of our encoder-decoder network is mainly based on a method called Long Short-Term Memory (LSTM), which is a type of Recurrent Neural Network that has been showing good performance when dealing with translations. This model, later, will be used in a text analysis system to provide a more concise summary of the collection to the analyst, showing only the labels rather than lists of keywords.

## I. INTRODUCTION

With the increasing number of text data being produced, text analysts have used text summarization techniques as a way to understand the contents of a text collection without reading all of it. One such method is topic modeling [3]; topic modeling uses statistical inference to automatically extract a set of topics that convey what the central themes described in the data are. For each document, it assigns one or more topics, of which each is represented by a list of keywords that the analyst has to interpret and often assign an actual label to it. For example, the method may output a topic represented by the words “school”, “student”, “college” and “university”.

The analyst may assign the label “education” to it. Many methods have been proposed to automate the label assignment step [10]; these methods often rely on using the keywords to query a general knowledge dataset like Wikipedia and

using the title of the articles as labels. These methods restrict the possible labels only to the different titles in the dataset where the query was executed, and also, relies solely on the keywords extracted by the topic modeling algorithm, ignoring the content of the documents associated to the given topic.

### A. Current Application and Motivation

Current topic modeling systems provide analysts with rows of topics and columns of labels as presented in Figure 1.

Topic 0	Topic 1	Topic 2	Topic 3
clinton	president	bomb	percent
party	report	strike	america
republican	investigate	drone	rate
politics	house	lewis	job
obama	email	meme	worker
sander	official	pakistan	year
democrat	clinton	ridge	increase

Figure 1. Table of Topics

Imagine having to sort through thousands of New York Times articles by topic. Current applications provide a list of multiple topics each displayed as a list of key words. Consider a collection containing 50 topics and 50 keywords per topic. Multiplying the number of topics by the number of keyword leaves the system with a set of 2500 keywords to show to the user. This equates to an unreasonable amount of time spent for a human to sort through in order to group together relevant articles and understand the content of the dataset.

Our goal is to implement our model in a text analysis system to provide a more concise summary of the collection to the analyst, showing only the labels rather than lists of keywords.

The model will considerably improve searching large complex text collections and help analysts to visualize, explore and understand large collections of texts.

## II. IMPLEMENTATION

Our program was implemented in the Python programming language [9] with Tensorflow [1] as the framework for the model.

Dependencies include:

- Gensim [8]-Used to create topic

modeling through NLP.

- NumPy [6] - Provides the fundamental data structures for storing data.
- Global Vectors for Word Representation (GloVe) [7] – Word embedding.

### A. Model 1

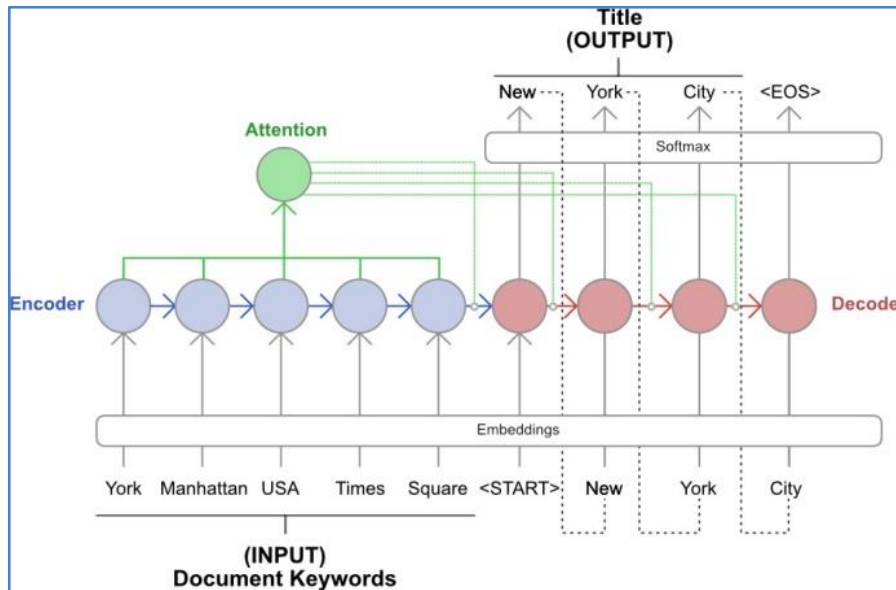

Figure 2. Model 1 Neural Network

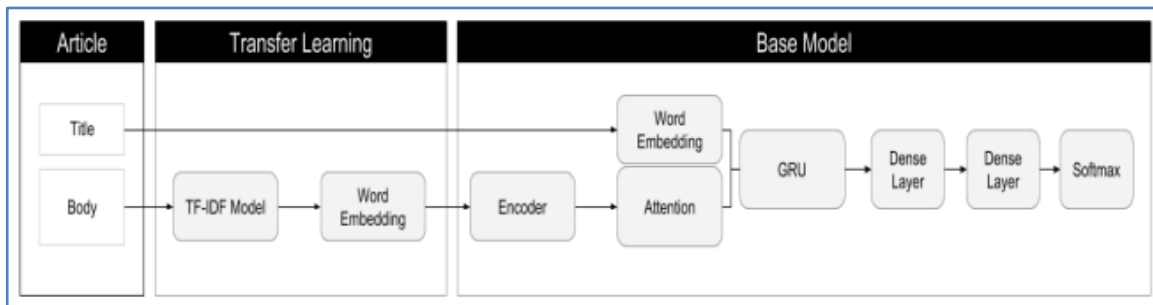

Figure 3: Model 1 Flowchart

The first model uses a Recurrent Neural Network (RNN) [5]. This type of neural network works by feeding the output back as the input to produce new outputs, for example, for text generation, the text already generated is fed into the model to produce the next word in the sequence. Because of these characteristics it has shown good performance when generating text data and seemed to be a good candidate for the first experiment. The goal of the first experiment was to understand how current state-of-art architectures would perform in our scenario. More specifically we wanted to understand how these models would perform in the task of predicting the title of an article given

a set of keywords extracted from its content.

The input included the keywords extracted from the article's content, and it was expected to output the title. We used GloVe [7], to get the word embedding for each word which represents the semantics of the word. The attention layer provides a context vector, giving the decoder access to the original list of keywords, and which one should the decoder pay attention to when generating the next word in the sequence [2].

The next step is the Gated Recurrent United. It is the core of the model and the recurrent element of it. For the GRU, the hidden state  $h_t$  is computed as

$$z_t = \sigma(x_t U^z + h_{t-1} W^z) \quad (1)$$

$$r_t = \sigma(x_t U^r + h_{t-1} W^r) \quad (2)$$

$$\tilde{h}_t = \tanh(x_t U^h + (r_t * h_{t-1}) W^h) \quad (3)$$

$$h_t = (1 - z_t) * h_{t-1} + z_t * \tilde{h}_t \quad (4)$$

Here  $r$  is a reset gate, and  $z$  is an update gate. Intuitively, the reset gate determines how to combine the new input with the previous memory, and the update gate defines how much of the previous memory to keep around. If the reset is set to all 1's and update gate to all 0's, it will be equivalent to the vanilla RNN model.

The output from the GRU is then sent through a dense layer. A dense layer is a linear function over the output of the previous value that the GRU outputted, multiplied with some previously computed weights. Finally, the output is sent through a softmax activation function.



Figure 4: Softmax

The softmax function squashes the outputs of each unit to be between 0 and 1; as seen in Figure 4. But it also divides each output such that the total sum of the output vector is equal to 1.

The output of the softmax function is equivalent to a categorical probability distribution; it tells you the probability that any of the classes are true.

$$\sigma(\mathbf{z})_j = \frac{e^{z_j}}{\sum_{k=1}^K e^{z_k}} \quad (5)$$

Mathematically the softmax is function (5), where  $\mathbf{z}$  is a vector of the inputs to the output layer (if you have 10 output units, then there are 10 elements in  $\mathbf{z}$ ). And again,  $j$  indexes the output units, so  $j = 1, 2, \dots, K$ .

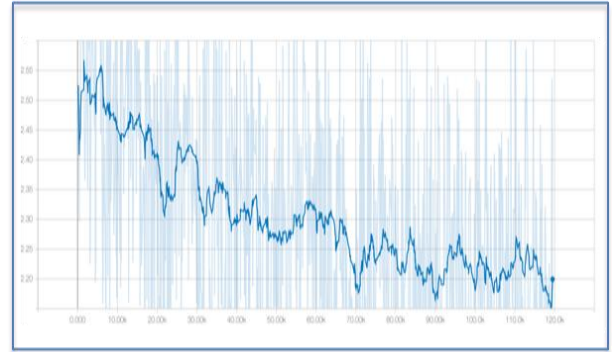

Figure 5: Model 1 Loss Graph

As the model trained on a GTX 1080 GPU in the NYU HPC, the loss of the model exponentially decreased. The lower the loss, the better a model. The loss is calculated on training and validation, and its interpretation is how well the model is doing for these two sets. Loss is a summation of the errors made for each example in training or validation sets. Figure 5 represents the loss of the model after 10 hours of training. The loss was decreasing, but with the current rate, it could take weeks to reach usable results. Therefore, we stopped the training of our first model and switched to a second experiment to understand how we could improve the training speed of the model.

#### B. Model 2

The second model is a simplified version of the first, with a new word embedding model. Fast-Text [4] provides a trainable sub-word embedding model which brought increased efficiency and performance gains.

To reduce the time to train, even more, we replaced the activation function (5) with a Hierarchical softmax. Hierarchical softmax is a replacement for softmax which is faster to evaluate. While softmax is  $O(n)$  time, hierarchical softmax is  $O(\log n)$  time. However, some accuracy is lost in the process: this loss can often be neglected when working with large datasets.

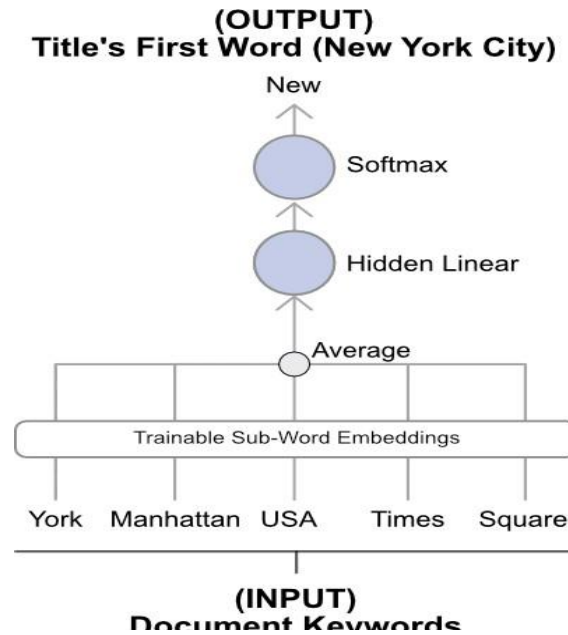

Figure 6: Model 2 Neural Network

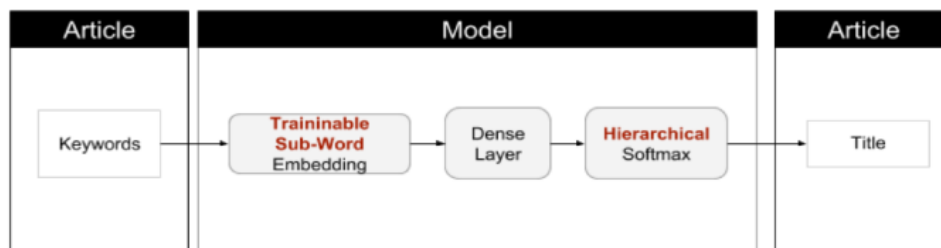

Figure 7: Model 2 Flowchart

### III. TRAINING

The models were trained on a truncated database dump of every Wikipedia article, and a private dump of every New York Times article up to 2008.

#### A. Processing

To process all the articles to provide as an input to the model, the titles and content were one-hot encoded, and padded. Every word is represented as a vector, where each word receives a number  $I$  based on a dictionary, and converted to a vector with the size equal to the size of the vocabulary, and all entries are set to 0 with exception of the entry at the  $I$ th position, which is set to 1.

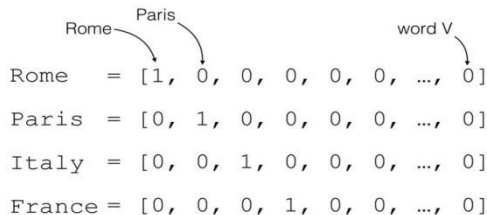

Figure 8. One-Hot encoded words [12]

Figure 8 shows a one-hot encoded sample set of words. Though this method comes with its own set of restrictions, such as costly dictionary lookups per word can decrease performance and increase training and prediction time; also each word vector has a very large dimension because of the size of the vocabulary, which increases the number of parameters a neural network has to learn. To overcome these limitations, those vectors are often used as a way to query an embedding matrix, and there for being replaced by more dense vectors and with a much smaller number of dimensions.

### IV. RESULTS

#### A. Model 1

The box below displays three different predictions from the model. They are related to what the model had learned, and loosely title the Wikipedia article of New York that was used as an input.

Model 1 results after 10 hours of training on GPU:

- a new york manhattan
- the 21<sup>st</sup> century
- the times the times the times

The model was able to learn how to combine multiple words and make short sentences with relevance to the article. Longer training time on the GPU is required to create longer sentences with cohesive meaning.

### B. Model2

TABLE I. ACCURACY OF MODEL 2 WITH THE TOTAL TRAINING TIME

GPU Training Time	Correct First Word	Correct Word in Top 5 of Total Words
1 hour	62% of the time	92% of the time
10 hours	75% of the time	96% of the time

Immediately Model 2 was showing higher accuracy and lower time for training required to provide such results. The percentages from Table I are result of retrofitting Model 2 to generate the first word of the title for the article, then passing it into Model 1 as a planted output. Model 1 will then use the given first word to generate a more accurate prediction for the title of the article.

### V. DISCUSSION

The current direction of the project is to implement and experiment with different neural network structures and improve the dataset pipeline for processing and training.

#### A. Limitations of our Model

Sparsity and Data-hunger of the model: initially we thought the Softmax activation function would allow us to train the model with less initial data. However, we switched to a Hierarchical Softmax to reduce training time, which came at the cost of providing more data to the model to account for the loss of accuracy.

When training the model, the amount of dense one-hot encoded vectors needed as input use up large amounts of system RAM and GPU RAM. We've been able to alleviate the problem by pre-computing the inputs and batching, however, a better solution is needed.

#### B. Future Work

$$tfidf(t, d, D) = tf(t, d) \cdot idf(t, D) \quad (6)$$

Subtracting Inverse Document Frequency (IDF) from Term Frequency (TF) provides a faster alternative to word embedding to

determine the relevance of a word in an article. A high weight in  $tf-idf$  is reached by a high term frequency (in the given document) and a low document frequency of the term in the whole collection of documents. This provides us with a much better representation of the words in the document, which we can use to present to an analyst for a more in-depth analysis of the document.

After we finish that, we will emphasize on creating a more efficient input vector. We're working on using Gensim [8] dictionaries with every document from the dataset(s) indexed. This would let us reference every word as a number through an in-memory dictionary rather than a one-hot encoded vector, and in-turn brings improvements to model training speeds.

Within the next few months our completed model will be ready, and we can work on implementing an online interface for exploring documents through our topic modeling algorithms.

### VI. CONCLUSION

We presented a new attention-based neural network for determining the relevance of multiple documents and predicting a title to classify their content. The core idea is to use Neural Networks to classify a broad set of documents with different origins and categories, and provide a concise title to explain what the set of documents contain.

As an example of our approach, we demonstrated it by predicting title names of a Wikipedia article using a model that was trained on more than 5 million Wikipedia articles. However, our model had some shortcomings with the demonstration which we are working on as outlined in our future work.

We believe that the attention-based model which uses a holistic representation of documents can serve as a basis for a wide range of topic modeling and document prediction.

#### NOTE:

Due to the nature of the project, the source code is not available to the public yet. If anyone reviewing this paper would like access to the source code, please contact me at: [efecan.balci@nyu.edu](mailto:efecan.balci@nyu.edu).

### REFERENCES

- [1] A. M. Agarwal, A. Barham, P. Brevdo, E. Chen, Z. Citro, X. Zheng, et al. (2015) TensorFlow: Large-scale machine learning on heterogeneous systems. Retrieved from <https://www.tensorflow.org/> (Software available from tensorflow.org)
- [2] Bahdanau, D., Cho, K., & Bengio, Y. (2014). Neural machine translation by jointly learning to

- align and translate. CoRR, abs/1409.0473. Retrieved from <http://arxiv.org/abs/1409.0473>
- [3] Blei, D. (2012). Probabilistic topic models. *Commun. ACM*, 55 (4), 77–84.
- [4] Bojanowski, P., Grave, E., Joulin, A., & Mikolov, T. (2017). Enriching Word vectors with subword information. *Transactions of the Association for Computational Linguistics*, 5, 135–146.
- [5] Goodfellow, I., Bengio, Y., & Courville, A. (2016). *Deep learning*. MIT Press. (<http://www.deeplearningbook.org>)
- [6] Oliphant, T. (2006–). *NumPy: A guide to NumPy*. USA: Trelgol Publishing. Retrieved from <http://www.numpy.org/> ([Online; accessed September 24, 2019])
- [7] Pennington, J., Socher, R., & Manning, C. D. (2014). Glove: Global vectors for word representation. In *Empirical methods in natural language processing (emnlp)* (pp. 1532–1543). Retrieved from <http://www.aclweb.org/anthology/D14-1162>
- [8] Rehkrek, R. & Sojka, P. (2010, May 22). Software Framework for Topic Modelling with Large Corpora. In *Proceedings of the LREC 2010 Workshop on New Challenges for NLP Frameworks* (pp. 45–50). Valletta, Malta: ELRA. (<http://is.muni.cz/publication/884893/en>)
- [9] Rossum, G. (1995). *Python reference manual* (Tech. Rep.). Amsterdam, The Netherlands.
- [10] Yang, Z., Yang, D., Dyer, C., He, X., Smola, A., & Hovy, E. (2016). Hierarchical attention networks for document classification. In *Proceedings of the 2016 conference of the north American chapter of the association for computational linguistics: Human language technologies* (pp. 1480–1489).
- [11] Zeiler, M. D. (2017). Attention is all you need. arXiv preprint arXiv:1706.03762.
- [12] Bonzanini, M (2017), Word Embeddings for NLP in Python, London Python Meet-up, September, 2017.



# Using Oracle REST Data Services for Generating JSON Documents

S. Nogo and D. Manjak

*Faculty of Electrical Engineering, University of East Sarajevo, Bosnia and Herzegovina*

srdjan.nogo@gmail.com, dragan.manjak@etf.ues.rs.ba

**Abstract** - This paper investigates technical possibilities for generating Java Script Object Notation (JSON) documents from database using Oracle REST Data Services-a (ORDS-a). We will describe and show practical model for inserting JSON documents in MongoDB database. Theoretical model will be cloned and applied to practical model for production using software tools SQL Developer and Oracle APEX in combination with Mongo. Testing of proposed solutions will be done with Postman software environment.

## I. INTRODUCTION

A question “What is optimal data interchange format for data exchange between client and servers?” brings a whole list of answers. The first option is XML format, so as other simpler formats used in data exchange processes of the smaller network bandwidth. According to Sriparasa in [1], “JSON has come about to be the preferred Internet data interchange format, to avoid the issues like slow page loads, hang ups, and poor user experience, thus driving the users away from site”. This statement implies that JSON data exchange format in two way interaction between client and servers on different types of data bases as data resource is the most optimal solution to be chosen. JSON allows programmers to store and set values, lists, and key value mapping throw entire system. For example, Smith in [2] gives a definition that: “JSON is famous as standard for data exchange and it is a subset of Java Script language, which means that it can be used as data format wherever data sharing occurs”. This definition makes us conclude that JSON is not just a program language. It is already optimal to be used as a data exchange format and very readable by humans.

JSON as the data exchange format is most effective when combined with a database that does not belong to a relational database structure, in other words, one that is not built in tabular relationships. The JSON format should work and provide best results on NoSQL database type. The main reason for this is that NoSQL type of databases work with simpler data structure and storage management than SQL databases.

In this paper we will focus on programmers’ demands to use upgrade NoSQL technology performance for migration of data from relational databases into NoSQL databases using JSON format.

For example, JSON format uses documents with a nice combination of simplicity for import into MongoDB

database, which is one of the most famous representatives of document oriented databases. The data in the MongoDB database is stored in JSON format where documents are divided into collections and form the basis for the development of applications in global cloud platforms.

This paper is structured as follows: After the introduction, where we provide answer about the optimal data interchange format for data exchange between client and servers, there is Section II describing methods for Generating JSON format documents and their export from relation to NoSQL database in a easily readable format for programmers. It was developed, as the usage is concerned, as a starting basis for the proposed solution for generating JSON format with usage of ORDS-a tool outlined in section III. Section III contains the main focus of this survey paper with technical details required for implementation of conceptual solutions for usage of JSON format documents as a software tools for data exchange. Practical example of import of JSON documents into Mango DB is described in Section III, part C, providing us with a visual means to confirm our summary and conclusions outlined in Section IV.

## II. RELATED WORK

During pre-defined timeframe with precise deadline for application development, which requires repetitive and redundant tasks along with omittance of human and manual involvement, the optimal way is to use software tool to make it easy for the programmers and achieve faster migration of data form SQL to NoSQL database using JSON format.

Narayanan in [3] states that: “Oracle REST Data Services (ORDS) is based on Java EE and was developed as a substitute for other normally used web services options”. This indicates that we have to use an appropriate software tool, such as ORDS, to ensure compatibility with JSON format. Moreover, when we start generating JSON format, it is necessary to clarify a list of requirements to create services and determine precise list of commands.

Kaur and Gupta in [4] state that: “If we do not have a list of requirements, we may waste time for downloading, installing and evaluating tools that only meet some of requirements, or may not meet any of them”. The following phase will be to create data source relation database, where we are going to use ORDS service start command GET which will generate request

for creation of JSON document prepared for import into Mongo DB database. The main objective is to generate documents in JSON format that will contain data from multiple interconnected tables from a relational database, to achieve scalability and simplicity for future data manipulating procedures in NoSQL database. Providing such optimal level of quality assurance from the programmer's point of view is very important, as it guarantees that he/she can run the application in any available web browser, using any of its versions.

In this paper, we will use SQL Developer Version 18.2.0 as a tool for generating JSON format, Oracle APEX Version 18.2 combined with Mongo DB Version 4.0.2. Use of the above software packages will enable us to generate JSON documents using ORDS services. In that process we are going to use Representational State Transfer (REST) protocol which is bonded with Hyper Text Transfer Protocol (HTTP) protocol, precisely REST protocol is built in the HTTP basic, Lozić and Šimec in [5] state that, "REST protocol, as HTTP has possibility GET, POST, PUT and DELETE methods to the server". Testing of JSON format documents requires software environment and use of Postman software tools. Postman software tools allows users to quickly put together both simple and complex JSON document format with deployment of user friendly documents Application programming interface (API).

### III. IMPLEMENTED SOLUTIONS

This section describes relational database named „Library“, where the process of generating JSON format starts. Relational model of the database itself is shown at "Fig. 1".

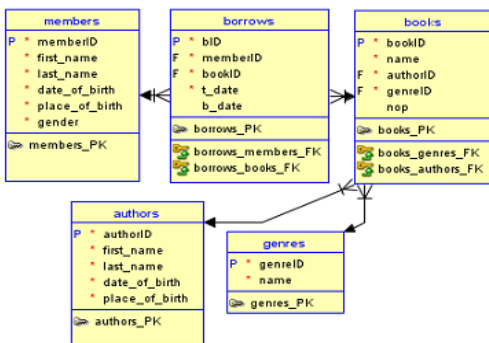

Figure 1. Relation model of the Library database

There are several different options for just presenting a relational database schema in JSON format. For example, one option is to send a GET request for each individual row for the member ID column in the Borrows table to get a report for each member in JSON format. When running GET requests, we note that, in this case, the JSON document should contain data from multiple tables. By sending a GET request, we initiate the procedure of generating a document that will contain information about the member, namely: name, surname, date of birth, year of birth, place of birth as well as information about the current status of debit book for each member

individually. As shown in Fig.1, we can see that the debit data contains data on the books raised, so it is necessary to include the book title information in the JSON document as well as the authors and genres data given in separate tables relative to the memberID column.

#### A. Creating RESTful services

Mehta in [6] states that: "REST is bound by the principle of statelessness". Each request from the client to the server must include all the details to be understandable. This improves visibility, reliability, and scalability of the requests. Consequently, we can conclude that we need stateless services with a possibility to change a code on the client side at any time without affecting the functionality of the server and opposite. That is the main reason that in our research we are going to use REST compliant system, known as RESTful system having all the principles of statelessness. For creation of RESTful Services, we will create module library by using of software package Oracle APEX-Ver. 18.2, as shown in Fig. 2.

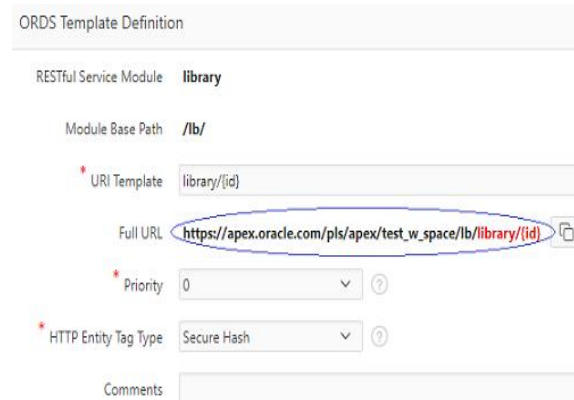

Figure 2. Creating RESTful service

As given in Fig. 2, based on sending a GET request, we get the URL at the following link: [https://apex.oracle.com/pls/apex/test\\_w\\_space/lb/library/{id}](https://apex.oracle.com/pls/apex/test_w_space/lb/library/{id}), which contains the generated JSON document. The next step is to create Handler GET as given in Fig. 3.

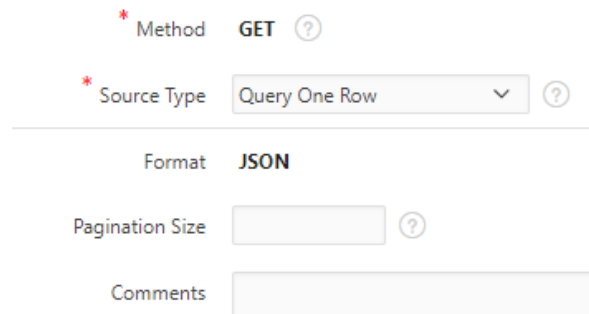

Figure 3. Creating Handler GET

After creating the GET Handler we get the field with source code as shown in Fig. 4.

```
select memb.memberID as "id",
    memb.first_name as "First Name",
    memb.last_name as "Last Name",
```

```

memb.place_of_birth as "Place of birth",
to_char(memb.date_of_birth, 'DD-MON-YYYY') as "Date
of birth",
cursor(
    select br.bID as "id",
          b.name as "Book",
          g.name as "Genre",
          a.first_name || ' ' || a.last_name as "Author",
          b.nop as "Number of pages",
          to_char(br.t_date, 'DD-MON-YYYY') as
"startDate",
          to_char(br.b_date, 'DD-MON-YYYY') as
"endDate"
    from borrows br, books b, authors a, genres g
    where br.memberID = :id
    and b.bookID=br.bookID
    and a.authorID=b.authorID
    and g.genreID=b.genreID
    order by br.t_date
) as "borrow"
from members memb
where memb.memberID =:id

```

Figure 4. Source code Handler GET

Based on the code written in the source field, and based on sending a GET request, we have the ability to generate the JSON document in the desired format. In the generated document, previously described in this chapter, we have the option of compatible sub-document embedding. As we have already shown in this chapter, based on the generated code in the source document field, it contains member information and the following information (name, surname, birth and date of birth), we also have debt information (title of book, genres, page number, writer name, borrowing date and return date). These data listed above are in different tables and we can see what scalability and flexibility the JSON format generation tools have design.

Final design of created library model with GET handler for library/{id} is given in Fig. 5.

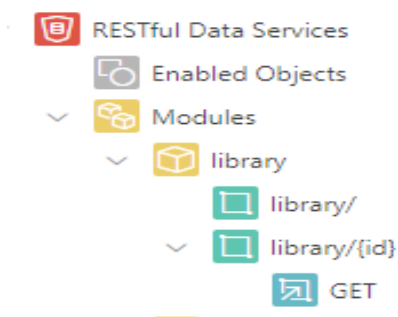

Figure 5. Library model

### B. Testing JSON formats

According to Myers, Sandler and Badgett [7]: "Software testing is a process, or a series of processes, designed to make sure computer code does what it was

designated to do and, conversely, that it does not do anything unintended". This makes us conclude that the main objective of testing is to find bugs in computer code and fix them, thus improving the quality of software.

In our case, we are going to use Postman tool to test source code Handler which can be used for automated testing environment. Kankaname in [8], claims: "Test automation frees up the tester's time to do more effective and exploratory tests which are crucial for the success of quality assurance". Providing such quality assurance optimal level from the user's point of view is very important, as it guarantees that he can run the application in any available web browser, using any of its versions. Automated tests combined with tools which enable setting for time to time test run with no human presence, present achievement of automatized process goals. Postman is completely API environment and it offers the programmer's environment to test any software source code. Postman tool interface is shown in Fig. 6.

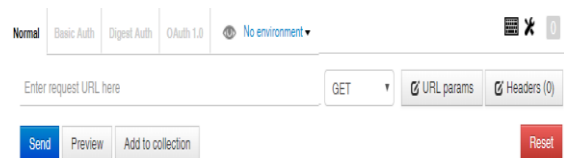

Figure 6. Postman tool interface

In order to start the testing process, we need to enter words "enter request URL here" in the appropriate field, the correct link with the address containing the generated JSON document and a specific member with ordinal number(1):

[https://apex.oracle.com/pls/apex/test\\_w\\_space/lb/library/1](https://apex.oracle.com/pls/apex/test_w_space/lb/library/1), (1)

And to click on option Send, as is shown in "Fig. 7".

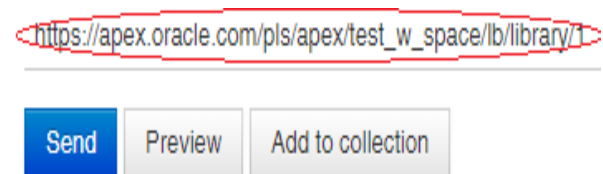

Figure 7. Sending request for testing

After we have sent GET request to be tested, we receive the answer on the screen as a status number code and, in our case, the requested value is 200. It means that sending is done successfully, as shown in Fig. 8.



Figure 8. Status number code after sending GET request

In case that we didn't create properly a Handler GET, the status code will be different. The success/failure

report after the passed method uses HTTP status codes, most often in the value specified in Table I.

TABLE I. STATUS NUMBER COD IN POSTMAN TEST SOFTWARE

METHOD	Successfully	Unsuccessfully
GET	200	404
POST	200,201	409
PUT	200	404
DELETE	200,204	400

A document whose format is validated and created after submission of GET request is shown in desired format as shown in Fig. 9.

```

1 {
2   "id": 1,
3   "first name": "Marko",
4   "last name": "Petrovic",
5   "place of birth": "Sarajevo",
6   "date of birth": "23-FEB-1995",
7   "borrow": [
8     {
9       "id": 1,
10      "book": "Na Drini Ćuprija",
11      "genre": "historical novel",
12      "author": "Ivo Andric",
13      "number of pages": 387,
14      "startdate": "23-FEB-2019",
15      "enddate": "05-MAR-2019"
16    },
17    {
18      "id": 3,
19      "book": "The Grand Design",
20      "genre": "science book",
21      "author": "Stephen Hawking",
22      "number of pages": 355,
23      "startdate": "26-FEB-2019",
24      "enddate": "08-MAR-2019"
25    },
26    {
27      "id": 2,
28      "book": "Prokleta Avlija",
29      "genre": "novel",
30      "author": "Ivo Andric",
31      "number of pages": 296,
32      "startdate": "28-FEB-2019",
33      "enddate": "06-MAR-2019"
34    }
35  ]
36 }

```

Figure 9. Generated JSON document

The document is presented in JSON format, based on code in the source field by creating of handlers GET for library/{id}. In this case, we have sent request for member with ID (1). In order to get JSON format data for another member, all you have to do is enter its id in library/{id}. Changing the code will also change the document format. In this case, it is simple to include the new assignment in this document and also to delete and change the existing assignment.

### C. Import JSON documents into Mongo DB

The basic prerequisite to import pre-generated documents from a relational database using JSON format is to create a MongoDB database. It can be done by using a simple command *use library*, where library name of database that we are creating is given in Fig.10.

```

> use library
switched to db library
> show collections
>

```

Figure 10. Creating library database

There are no collections in the database after creation. To start importing data into a database using the mongo import tool, it is necessary to create a MongoDB.json document. The main function of mongo import tool is to import content from JSON format into the database. We can save the document received as a result of sending a GET request under the name borrows.json. The next step is to take advantage of the functionality of the mongo import tool and import this document into a collection called *borrows*, within the library database as given in Fig. 11.

```

C:\Program Files\MongoDB\Server\4.0\bin>mongoimport --
db library --collection borrows --file
D:/Desktop/borrows.json
2019-03-20T08:11:10.169+0100  connected to: localhost
2019-03-20T08:11:10.221+0100  imported 1 document

```

Figure 11. Importing JSON file into MangoDB

After we re-inspect the collections with the command *show collections*, we notice that the collection *borrows* appears, as shown in Fig.12.

```

> show collections
borrows
>

```

Figure 12. View of collection in database

The document created in this way is suitable for adding of new assignments for a member whose ID is 1, as well as for adding new assignments for other members. By looking at the collection *borrows* the command (2):

```
db.borrows.find().pretty()(2)
```

, we get report as given in Fig.13.

```
> db.borrows.find().pretty()
{
  "_id" : ObjectId("5c91eb27eb05f9fa68286947"),
  "id" : 1,
  "first name" : "Marko",
  "last name" : "Petrovic",
  "place of birth" : "Sarajevo",
  "date of birth" : "23-FEB-1995",
  "borrow" : [
    {
      "id" : 1,
      "book" : "Na Drini Ćuprija",
      "genre" : "historical novel",
      "author" : "Ivo Andric",
      "number of pages" : 387,
      "startdate" : "23-FEB-2019",
      "enddate" : "05-MAR-2019"
    },
    {
      "id" : 3,
      "book" : "The Grand Design",
      "genre" : "science book",
      "author" : "Stephen Hawking",
      "number of pages" : 355,
      "startdate" : "26-FEB-2019",
      "enddate" : "08-MAR-2019"
    }
  ],
  {
    "id" : 2,
    "book" : "Prokleta Avlija",
    "genre" : "novel",
    "author" : "Ivo Andric",
    "number of pages" : 296,
    "startdate" : "28-FEB-2019",
    "enddate" : "06-MAR-2019"
  }
]
}
```

Figure 13. Collection *borrows*

In the next section D we will focus on detailed procedure for adding subdocuments into collection *borrows*.

#### D. Adding subdocuments

By generating JSON document structure, there is a possibility of adding subdocuments into collection. We will add a new command within the existing assignments for a member that has `id = 1` using the command (3):

&push (3)

By executing this command, on new charge for the book as given in Fig. 14.

```
> db.borrows.update(
...   { "id": 1 },
...   {
...     $push: {
...       "borrow": {
...         id: "4",
...         "book": "Holographic universe",
...         "genre": "science book",
...         "author": "Michael Talbot",
...         "number of pages": "345",
...         "startdate": "10-FEB-2019"
...       }
...     }
...   }
... )
WriteResult({ "nMatched" : 1, "nUpserted" : 0, "nModified" : 1 })
```

Figure 14. Adding new charge for the book

As given in Fig.15, when we list the current state of the borrowed book in the database library, we can see that new information for the book has been successfully finished.

```
> db.borrows.find().pretty()
{
  "_id" : ObjectId("5c91eb27eb05f9fa68286947"),
  "id" : 1,
  "first name" : "Marko",
  "last name" : "Petrovic",
  "place of birth" : "Sarajevo",
  "date of birth" : "23-FEB-1995",
  "borrow" : [
    {
      "id" : 1,
      "book" : "Na Drini Ćuprija",
      "genre" : "historical novel",
      "author" : "Ivo Andric",
      "number of pages" : 387,
      "startdate" : "23-FEB-2019",
      "enddate" : "05-MAR-2019"
    },
    {
      "id" : 3,
      "book" : "The Grand Design",
      "genre" : "science book",
      "author" : "Stephen Hawking",
      "number of pages" : 355,
      "startdate" : "26-FEB-2019",
      "enddate" : "08-MAR-2019"
    }
  ],
  {
    "id" : 2,
    "book" : "Prokleta Avlija",
    "genre" : "novel",
    "author" : "Ivo Andric",
    "number of pages" : 296,
    "startdate" : "28-FEB-2019",
    "enddate" : "06-MAR-2019"
  },
  {
    "id" : 4,
    "book" : "Holographic universe",
    "genre" : "science book",
    "author" : "Michael Talbot",
    "number of pages" : "345",
    "startdate" : "10-FEB-2019"
  }
]
}
```

Figure 15. View of documents after new added charge for the book

#### IV. CONCLUSION

This paper outlines one of the mechanisms for generating JSON documents from relational database, so as its importing into MongoDB database.

Based on this mechanism, we presented concrete solution and achieved the main goal of this research and that is to generate documents in JSON format which will encompass data from several connected tables from a relational database and to import those documents into NoSQL database. We have proposed a solution that seems to be the most optimal and easily used. In presented solution, outlined in Chapter III, we have achieved scalability and simplicity for JSON format documents that encompass all necessary data facilitating the manipulation of data in NoSQL database. We especially need to outline these properties because we have determined the solution that needs to generate JSON format documents whose source data resides in different relational database tables and whose final layout should match the request of end users. The proposed solution offers the possibility of a data pump with data from one type of database to another, saving the time of the programmer or software and hardware resources for additional traditional exports and imports using additional software tools.

Finally, this research paper can be extended with extra modules and software tools, allowing the setting to automatically new models with the minimum presence of a human, thus making the process more automatized which is one of the most important goals of each programmer.

#### REFERENCES

- [1] S. Sriparasa Series: Community Experience Distilled. Birmingham, UK : Packt Publishing. 2013. eBook., Database: eBook Collection (EBSCOhost), pp. 15-25.
- [2] B. Smith, Beginning JSON, 1st ed. Edition, Apress, 2015, pp. 37-49.
- [3] Narayanan, Ajith. Oracle SQL Developer. Packt Publishing, 2016, pp. 295-300
- [4] Harpreet Kaur , Dr. Gagan Gupta , Comparative Study of Automated Testing Tools: Selenium, Quick Test Professional and Testcomplete , Int. Journal of Engineering Research and Applications, ISSN : 2248-9622, Vol. 3, Issue 5, Sep-Oct 2013, pp. 1739-1743
- [5] Lozić D, Šimec A, Pametna komunikacija na internetu preko REST protokola, Mipro 2014, Opatija, pp. 3-4.
- [6] Mehta, . RESTful Java Patterns and Best Practices. Birmingham: Packt Publishing. 2014, pp- 8-10.
- [7] G. J. Myers, C. Sandler, T. Badgett, ISBN: 978-1-118-03196-4, Nov 2011. pp- 18-20.
- [8] C. Kankanamge, Web Services Testing with SoapUI. Birmingham: Packt Publishing. APA (American Psychological Assoc.), (2012), pp- 55-60.

# A Survey of ICT Competencies of Graduate Students at Traffic Engineering Faculty in Doboj

G. Jauševac \*, Ž. Stojanov \*\*, G. Jotanović \* and V. Brtko \*\*

\* Faculty of Transport and Traffic Engineering, Doboj, Republic of Srpska, Bosnia and Hercegovina

\*\* University of Novi Sad, Technical faculty "Mihajlo Pupin" Zrenjanin, Serbia

goran.jausevac@sf.ues.rs.ba, zeljko.stojanov@uns.ac.rs, gordana.jotanovic@sf.ues.rs.ba and vbrtko@tfzr.uns.ac.rs

**Abstract - Engineering practice is highly dependent on skilled and knowledgeable experts that solve everyday engineering problems. Contemporary business is based on a variety of information and communication technologies (ICT), requiring engineers with specific ICT competencies. These ICT competencies can be acquired during the study and later during the professional practice. This paper presents a study on inquiring ICT competencies of students at Traffic Engineering Faculty in Doboj, Bosnia and Hercegovina. A survey with graduate students was organized from 2015 to 2017. In survey participated two generations of students from the department for Telecommunications and postal traffic. Totally, nine ICT competencies were identified as the most valuable for the students. Based on the survey results, the proposals for curriculum improvements in the field of ICT were determined.**

## I. INTRODUCTION

Knowledge has been recognized as a complex asset for engineering practice with significant contribution to personal performance, capabilities, innovativeness and competitiveness of organizations [1]. Due to the recognized importance of knowledge, individual training and education plays important role in acquiring necessary knowledge and gaining skills for specific engineering tasks and projects. It is widely adopted that performances and business success of organizations depends on individual knowledge, experiences, qualifications, which emphasis the need for continuous learning and development of skilled workers [2]. Expert knowledge is accumulated through education and practical experience, enabling the expert to apply his knowledge and skills in order to be regarded as a professional [3]. The role of personal knowledge, skills, and attitudes are especially important in knowledge-intensive companies that rely on creative and knowledgeable persons [4]. In addition to technical aspects surrounding knowledge management practice in knowledge-based organizations, managing knowledge and skills span several disciplines such as economics, information systems, organizational theory, psychology, and sociology.

Globalization of business requires the use of Information and Communication Technologies (ICTs) not only for work but also for communication between

distributed persons and teams. This leads to the increased importance of codification, sharing and reuse of knowledge in distributed working environments, and relying on ICT knowledge and skills [5]. In addition, organizations gain competitive advantages by using personal competencies of their workers based on their knowledge skills and attitudes developed in the course of their education and professional practice. Unlike physical assets that diminish with use, competencies are enhanced and provide the engine for business development [6]. Personal competencies development gained increased attention in business organizations because employees are the main user and carriers of knowledge [7]. In contemporary business, knowledge and competencies management becomes one of the main challenges in managing human resources in knowledge-based organizations [8][9].

The proliferation of ICTs dramatically changed job requirements and responsibilities in many professions [10]. The development of ICT and relevant skills and competencies is essential for creating a knowledge-based society. This also affected education in many fields, resulting in the introduction of subjects dedicated to ICT in existing university curricula, and has lead to reengineering and improvement of education practice to meet industrial needs [11]. It becomes necessary to align education standards and curricula to employers' and market needs, especially in engineering disciplines [12].

Quantitative survey using a questionnaire technique of data collection is a commonly used for inquiring knowledge and competence issues in engineering education and practice. The main strength of the survey as a research technique is the possibility to generalize the opinions and beliefs of many people by studying a subset of them [13]. Surveys were widely used for inquiring ICT competencies among students, educators, and practitioners in industry. For example, surveys were use for examining the perceptions of ICT competencies among the digital natives and digital immigrants in teachers' education [14], employees' willingness to acquire ICT competencies and which factors are determining their adaptability to ICT developments [15], factors affecting the development of ICT competencies of teachers in primary schools [16], ICT competencies of master's degree students as future researchers and educators in Kazakhstan [17], and self-estimated overall and task-specific ICT skills of Library and Information Science students in Bangladesh [10].

## II. ICT COMPETENCES

In Serbia and Bosnia and Herzegovina, in the last two decades, the issue of competencies has deserved an important place in the professional circles, the general public and the literature.

The reasons for the different conception and definition of competence are stated by Winterton et al. [18], emphasizing that terminological confusion is often reflected in attempts to merge different concepts, inconsistent use of terms, as well as conditionality to different cultural traditions [19]. After a thorough review of the literature, it is found that, depending on the scientific discipline (psychology, linguistics, sociology, political science, economics or education) there are different approaches and definitions related to the concept of the competence.

The concept of competence implies a productive way of understanding the changing relationship between knowledge and work that is increasingly relevant to the contemporary society. It provides a dynamic and situational understanding of a human potential in work and life. Therefore, it can also serve as a productive concept for understanding the functioning of educational systems and their interaction with other learning and business environments [20].

Contemporary world is increasingly characterized by information technology-focused communication, and it has transformed it into a large globally connected community with the incredible spread of ICT. Information technologies are playing an increasingly important role in people's lives, and ICT competencies are becoming a functional requirement for the efficient work of people and society [21].

As ICT is a source of variety of strategic strengths, it is used in organizations operating in different domains. For these reasons, ICT skills are required in all areas of human activity. ICT is being applied in different areas of people's interest, for example, education, economics, law, medicine, transport, science, etc. Successful use of ICT depends not only on the availability, but also on the training of people that apply them in a given context [22].

ICT competence is the set of knowledge, skills, attitudes, abilities, strategies, and awareness required when using digital media to perform tasks, solve problems communicate, manage information, cooperate, create and share different content, and improve education efficiency and adequacy [23].

Figure 1. presents the elements of ICT competencies and the relationships between them. Understanding the nature and the scope of ICT competencies is not fixed, but is necessary for ongoing technological development. This is evident through the establishment of advanced Internet technology in recent years and the consequent changes in the way students construct knowledge and interact with others [24].

The way ICT competencies are used depends on the course in which they are applied, the learning outcomes, the objectives of the course and the nature of the students. In the context of higher education, it is necessary to reflect



Figure 1. Organizing elements for ICT Competence [24]

on what professional competencies based on information technologies are required for students to become active members of the civic community as well as a quality workforce in a knowledge-based society [25].

## III. CASE STUDY

The case study was carried out to identify and improve the ICT competencies of the students at the Traffic Engineering Faculty in Doboj. The process of identifying the ICT competencies by graduates is a continuous process of seeking opinions from students who have completed the curriculum.

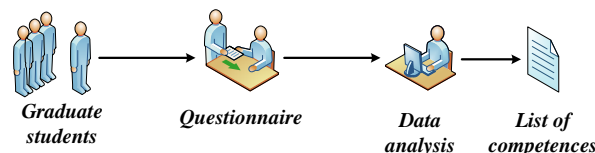

Figure 2. Procedure for the identification of ICT competencies of graduate students

As shown in Figure 2, we begin the process by defining a group of students from Alumni Association formed at the institutions of higher education. We use a survey method to collect information from the graduate students.

Surveys are an objective means of gathering information about people's knowledge, beliefs, attitudes, and behaviors [26]. Surveys have several advantages over other forms of data collection: they are usually less expensive to administer; very little training is needed to develop them and can be easily and quickly analyzed after completion. Surveying is a complex process that involves asking questions clearly and unambiguously for the respondent to interpret, articulate their answer, and communicate it effectively to the researcher. When transmitted, responses must be typed, coded, and analyzed accurately so that they accurately reflect the views of the respondents [27]. Although surveying is not an ideal method for deep learning about any educational process, a survey can increase our understanding of almost any educational issue. Surveys are effective



because many variables can be measured without significantly increasing the research time or costs [28].

Graduate surveys were conducted by using open and closed questions [29] related to the application of information technology within the students' profession. The survey aimed to identify the required ICT competencies based on information technologies within a study program at Traffic Engineering Faculty in Doboj, East Sarajevo University, Bosnia and Herzegovina.

In the process of surveying, we adhered to the rules of anonymity of the participants in the survey, for which we committed ourselves by signing the Consent to participate in the survey, which was part of the survey sheets.

Surveying of the graduates was conducted at the Traffic Engineering Faculty in Doboj in the time interval from 30.04.2015. to 30.04.2017. The study included two generations of graduates of the Traffic Engineering Faculty on the course Telecommunications and postal traffic. During the examination period, 45 students graduated, out of which 25 students were surveyed, representing 56% of the total number of graduates.

We reached graduates through the Alumni Association of Graduates at the Traffic Engineering Faculty in Doboj.

The first seven questions are general in nature and relate to a description of the graduate students' characteristics, the course of the study, and questions about current employment. An analysis of the first set of questions showed that out of the 25 graduates, seven of them are employed, or 28%, while the rest of the students at the employment bureau were looking for jobs or internships. Based on the first set of questions, we can conclude that graduates have an insight into the complete curriculum of the study program since they have passed it completely. In addition, they are able to use their skills and experiences in the ICT to get jobs in today's changing job market.

The second set of seven questions relates to the use of ICT knowledge and skills within the profession as well as for feedback related to the educational processes in information technology-based subjects. The analysis of the second set of questions, since the questions were mostly open-ended, was performed by using the qualitative methods for the analysis of the unstructured text [29], particularly inductive thematic analysis of the questions' content [30].

When asked "What knowledge related to information technology and software tools did you acquire during the study", 25 respondents provided the answers shown in Table 1.

As can be seen from Table 1, the respondents provided multiple answers. While on the question "Specifically what software tools do you use in your work", the respondents gave the replies shown in Table 2.

By comparing these two tables, we can conclude that more than 50% of the required competencies for working in practice have been acquired by students during their studies, although the sample of employed graduates is

small so that some more concrete conclusions can be drawn.

TABLE I. INFORMATION TECHNOLOGIES ADOPTED DURING THE STUDY AT THE FACULTY

No.	Software	Number
1	Office (Basic Knowledge)	19
2	Java (Basic Knowledge)	18
3	HTML	13
4	AutoCad (Basic Knowledge)	11
5	Matlab (Basic Knowledge)	10
6	MiniTab	4
7	SPSS	4
8	UML (Basic Knowledge)	4
9	Opnet	2
10	Sinchro 7	1

TABLE II. SOFTWARE TOOLS USED IN THE PROFESSIONAL WORK

No.	Software	Number
1	Word	1
2	Excel	1
3	Power Point	1
4	AutoCad	1
5	Radius	1
6	Dude	1
7	Winbox	1
8	email	1
9	TeleCad	1
10	CorelDraw	1
11	Microsoft Office	1
12	Visio	1
13	ASBU	1
14	EKPSistem	1
15	No answer	15

The answers to the question "How did you gain new knowledge in IT" are shown in Table 3.

TABLE III. HOW GRADUATE STUDENTS GAINED IT KNOWLEDGE

In the courses	Self-education	In postgraduate studies	In college	Through work
5	13	4	13	1
20%	52%	16%	52%	4%

The respondents also provided multiple answers to the question on how they gain IT knowledge. If we look at the answers in Table 3, we can see that most of the graduates have acquired knowledge in information technology at the faculty or through self-education process. Analysis of the received answers, where as much as 52% of the respondents answered that self-education is the primary source of knowledge, the need to incorporate additional ICT competencies into the curricula can be noticed. This brings us to the last question in the questionnaire "In your opinion, what areas of information technology should be studied at the Traffic Engineering Faculty ". Respondents' answers are presented in Table 4.

**International conference on Applied Internet and Information Technologies  
October 3-4, 2019, Zrenjanin, Republic of Serbia**

TABLE IV. SUGGESTION OF INFORMATION TECHNOLOGIES THAT SHOULD BE STUDIED AT THE TRAFFIC ENGINEERING FACULTY

No.	Information technology	Number
1	C++	9
2	Programming (Software Development)	8
3	HTML	7
4	AutoCad (Advanced Knowledge)	5
5	Software tools used in practice	5
6	Graphic Design	5
7	Softwares used in telecommunications networks	4
8	All areas (Advanced Knowledge)	3
9	Java Script	2
10	Office (Advanced Knowledge)	1
11	Telecommunications network design software	1
12	Software for traffic infrastructure design	1
13	No answer	3

By analyzing the data in Table 4, we were able to identify nine ICT competencies that we presented in Table 5.

TABLE V. PROPOSAL OF ICT COMPETENCIES TO BE INCLUDED IN THE CURRICULA

No.	ICT competencies
1.	Working in C ++ programming language
2.	Working in JavaScript programming language
3.	Work in the AutoCAD and TeleCAD GIS computer packages
4.	Working in the CorelDraw computer program
5.	Application of practical knowledge of HTML in telecommunication and postal traffic
6.	Working with commercial software in telecommunications networks.
7.	Work in telecommunications network design software.
8.	Programming in telecommunications and postal services.
9.	Development of software for the benefit of telecommunications and postal traffic

#### IV. CONCLUSION

Improving ICT competencies is an essential element in every education. With the example of the Traffic Engineering Faculty in Doboj, we were able to demonstrate a way for analyzing and improving students' ICT competencies. As a result of the research, we were able to identify nine ICT competencies that we can implement as part of the curriculum. By implementing the proposed ICT competencies into the curricula at the Traffic Engineering Faculty, we should give future traffic engineers a better starting position at the contemporary market, as well as better prior knowledge that they can apply in the engineering practice. The use of graduate engineers' experiences inquired in this study enables future students to adapt more easily to the work environments as well as to focus on the necessary knowledge for successful careers.

#### REFERENCES

[1] H. Mao, S. Liu, J. Zhang, and Z. Deng, "Information technology resource, knowledge management capability, and competitive advantage: The moderating role of resource commitment", *International Journal of Information Management*, 2016. vol. 36, no. 6, Part A, pp. 1062-1074, 2016.

[2] H. Urbancová, "Competitive Advantage Achievement through Innovation and Knowledge", *Journal of Competitiveness*, Vol. 5, No. 1, pp. 82-96, 2013.

[3] J. Olaisen, and O. Revang, "Exploring the performance of tacit knowledge: How to make ordinary people deliver extraordinary results in teams", *International Journal of Information Management*, vol. 43, pp. 295-304, 2018.

[4] Y. Hwang, H. Lin, and D. Shin, "Knowledge system commitment and knowledge sharing intention: The role of personal information management motivation" *International Journal of Information Management*, vol. 39, pp. 220-227, 2018.

[5] E. Bolisani, and E. Scarso, "Knowledge Codification and ICT Use in Business Networks", In *Encyclopedia of Knowledge Management (2nd Edition)*, D.G. Schwartz and D. Te'eni (editors), chapter 49, pp. 506-514. Hershey, PA, USA: IGI Global. 2011.

[6] C.K. Prahalad, and G. Hamel, "The core competence of the corporation", *Harvard Business Review*, vol. 40, no. 3, pp. 79-91, 1990.

[7] M. Rademakers, "Corporate universities: driving force of knowledge innovation", *Journal of Workplace Learning*, vol. 17, no. 1/2, pp. 130-136, 2005.

[8] R. Maier, *Knowledge Management Systems: Information and Communication Technologies for Knowledge Management (3rd Edition)*. Berlin Heidelberg, Germany: Springer-Verlag, 2007.

[9] F. Jorgensen, K.L. Becker, and J.H Matthews, "Human resource management and innovation: what are knowledge-intensive firms doing?", In *Enhancing the innovation environment: Proceedings of the 10th International CINet Conference*, pp. 451-463. Brisbane, Australia. 2009.

[10] M.A. Hossain, and E. Sormunen, "ICT Skills of Library and Information Science (LIS) Students in Bangladesh", *International Information & Library Review*, 2019. DOI: 10.1080/10572317.2018.1559661.

[11] A.J.C. Mole, C. L. Dim, and M.N. Horsfall, "Re-engineering LIS education to meet industrial needs for knowledge societies", *Journal of Librarianship and Information Science*, vol. 49, no. 3, pp. 313-319, 2016.

[12] R.S. Kuanysheva, A.Z. Assainova, M.I. Ragulina, and M.P. Lapchik, "Developing ICT Competences in Bachelors of Engineering and Technology in a Multilingual Environment", *International Journal of Education and Practice*, vol. 7, no. 3, pp. 123-135, 2019.

[13] M. Kasunic, *Designing an Effective Survey. HANDBOOK CMU/SEI-2005-HB-004*. Pittsburgh, PA, USA: Software Engineering Institute, Carnegie Mellon University. 2005.

[14] R. X. Guo, T. Dobson, and S. Petrina, "Digital natives, digital immigrants: An analysis of age and ICT competency in teacher education", *Journal of educational computing research*, vol. 38, no. 3, pp. 235-254, 2008.

[15] K. Tijdens, and B. Steijn, "The determinants of ICT competencies among employees." *New Technology, Work and Employment*, vol. 20, no. 1, pp. 60-73, 2005.

[16] V. Vitanova, T. Atanasova-Pachemska, D. Iliev, and S. Pachemska, "Factors affecting the development of ICT competencies of teachers in primary schools", *Procedia - Social and Behavioral Sciences*, vol. 191, pp. 1087-1094, 2015.

[17] D.B. Abykenova, A.Z. Assainova, E.I. Burdina, A. Murphy, and A.B. Abibulayeva, "Forming Master's Degree Students' ICT Competencies as Future Researchers and Educators: a Kazakhstan Case Study", *International Journal of Environmental and Science Education*, vol. 11, no. 18, pp. 11175-11193, 2016.

[18] Winterton, Jonathan, Françoise Delamare-Le Deist, and Emma Stringfellow, *Typology of knowledge, skills and competences: clarification of the concept and prototype*, Luxembourg: Office for Official Publications of the European Communities, 2006.

[19] Pavkov, Marija, and M. Živčić. "Značenje pojmova i uloga kompetencija i vještina u obrazovanju odraslih u kontekstu stjecanja stručnosti i razvoja osobnosti.", *Andragoške studije* 2, pp. 61-73, 2013.

[20] Salling Olesen, Henning. "Beyond the current political economy of competence development.", *European journal for Research on*

- the Education and Learning of Adults 4.2, pp. 153-170, 2013, <https://doi.org/10.3384/rela.2000-7426.rela9013>.
- [21] Danner, Regina B., and Clara OA Pessu. "A survey of ICT competencies among students in teacher preparation programmes at the University of Benin, Benin City, Nigeria," *Journal of Information Technology Education: Research* 12.1, pp. 33-49, 2013.
- [22] Amorim, M., Dias, M. F., Madaleno, M., Sarmento, C. M., & Putcrabey, S., Study on apprenticeship and ICT based learning practices in the crafts sector, 2018.
- [23] Ferrari, Anusca. "Digital competence in practice: An analysis of frameworks." (Technical Report No. JRC68116). Luxembourg: Joint Research Centre of the European Commission, pp. 95, 2012, <http://ipts.jrc.ec.europa.eu>.
- [24] Australian Curriculum, Assessment and Reporting Authority (ACARA), Information and Communication Technology (ICT) competence. Australian Curriculum, Assessment and Reporting Authority, 2010, <https://www.australiancurriculum.edu.au/f-10-curriculum/general-capabilities/information-and-communication-technology-ict-capability/>.
- [25] UNESCO. United Nations Educational, Scientific and Cultural Organization (UNESCO). "UNESCO ICT competency framework for teachers.", 2011, <http://unesdoc.unesco.org/images/0021/002134/213475e.pdf>.
- [26] Boynton PM, Greenhalgh T. Hands-on guide to questionnaire research: Selecting, designing, and developing your questionnaire. *BMJ*;328(7451):1312, 2004.
- [27] Wilkinson D, Birmingham P. Using research instruments: a guide for researchers. New York; London: RoutledgeFalmer, 2003.
- [28] Check J, Schutt RK. Chapter 8, Survey Research. In: *Research methods in education*. Sage Publications, pp. 159–85, 2012.
- [29] Given LM. *The Sage encyclopedia of qualitative research methods*. Sage Publications; 2008.
- [30] Braun V, Clarke V, Terry G. Thematic analysis. *APA Handb Res Methods Psychol*, 2, pp. 57–71, 2012.

# Maturity in Agile Software Development Processes

V. Erceg<sup>1</sup>, Z. Ćirić<sup>2</sup> and T. Zoranović<sup>3</sup>

<sup>1</sup> PhD student, University of Novi Sad, Faculty of Economics, Subotica, Segedinski put 9-11, 24000, Subotica, Serbia

<sup>2</sup> University of Novi Sad, Faculty of Economics, Subotica, Segedinski put 9-11, 24000, Subotica, Serbia

<sup>3</sup> University of Novi Sad, Faculty of Agriculture, TrgDositejaObradovića 8, 21101 Novi Sad, Serbia

vanja.erceg@gmail.com, zoran.ciric@ef.uns.ac.rs, tihomir@polj.uns.ac.rs

**Abstract - Context:** Agile software development aims to achieve higher software delivery speed, as well as greater flexibility during the software development process, and is focused on the value of products and satisfied users. **Aim:** This paper aims to find a unique definition of maturity in the agile software development, as well as to compile models for measuring maturity in order to determine their advantages and disadvantages. **Method:** In the first part of the paper, a systematic literature review was carried out in order to gain insight into the current state, followed by a comparative analysis of the model for measuring maturity in the agile software development. **Result:** 27 relevant studies were identified. Based on the analysis of the results, the definition of maturity in the agile software development is proposed and criteria for determining the level of maturity in the presented models are determined. **Conclusion:** The paper contributes to knowledge about software development by providing an overview of existing literature in this field, creating a foundation for analysis of the maturity measuring model in the agile software development and identifying the advantages and disadvantages of these models, which can enable IT companies to select the model in accordance with their needs.

## I. INTRODUCTION

Agile processes have appeared as a reaction to traditional software development processes. Namely, traditional software development is focused on so-called structured processes, such as Rational Unified Process (RUP), a waterfall model or a spiral model. The characteristic of structured processes is that they focus on strictly defined practices, require extensive documentation, detailed planning and management [5]. Agile processes in software development have been adopted since the 1990s, and the philosophy of agile software development is based on the values and principles identified in the Agile Manifesto [10]. The principles of the Agile Manifesto emphasize the value of each activity in the product development process, and those activities that do not add value to the product are considered unnecessary. Also, agile processes emphasize the importance of informal communication between actors and advocate small development teams instead of large structured units [3]. Agile software development includes processes such as Scrum, Kanban, eXtreme Programming and others. It is believed that agile development processes increase the ability of software companies to respond to dynamic changes on the market [1]. Agile processes have

allowed software companies to achieve their goals in terms of reducing the delivery time of software and improving the quality of their products. Recent studies have explored the advantages and disadvantages of structured and agile processes. The advantages of agile software development versus traditional software development are timely feedback from users, effective adaptation to changes and incremental delivery of software [4]. However, for software whose applications are well known and not subject to radical changes, structured development can offer greater control capability, while on the other hand, agile processes may be more convenient when requirements are subject to frequent changes [8]. Establishing a balance between agile and traditional software development practices requires common efforts by practitioners and researchers [18].

According to [15] maturity is defined as the degree to which processes are institutionalized and efficient. Also, the maturity of the process relates to the degree of utilization of the established software engineering method [23]. Instruments used to assess the maturity of elements (persons, objects or systems) and selecting appropriate actions for raising this element to a higher level of maturity are called models of maturity. Areas of application of the maturity model are widespread, but they are most commonly used in software engineering. Namely, in the domain of business information systems, 74 models of maturity have been identified, which prove their diversity and wide application [13]. The standard model for Software Process Improvement (SPI) is Capability Maturity Model Integrated (CMMI) [14]. CMMI includes several models, one of which is CMMI-DEV. CMMI-DEV is suitable for software development and offers a set of best practices for developing software products, from their onset to activation and maintenance. Similar to other models of maturity, CMMI-DEV has levels of maturity that recommend organizations the best way to implement their development processes [27]. Although high levels of CMMI maturity have been shown to improve success in environments in which traditional software development processes are applied, it has also been shown that this is not the case with agile environments [9]. In an effort to maintain agility [16] suggest the definition of maturity in agile software development that includes not only the improvement of the process, but also the subjective capabilities of actors, such as cooperation, communication, dedication, care, sharing

and self-organization. [7] argue that agility and CMMI can successfully coexist when agility is introduced into environments that are already at a high level of maturity. However, if the goal is to maintain agility at the highest level of maturity, the path of improvement cannot be based on existing models of maturity [17]. The definition of process development is inconsistent with the definition of agility. Namely, if agile principles set people up and interact in front of processes and tools, the path to improve these practices should not be based on the definition of the process [16]. For this reason, the literature suggests numerous agility models that are built on agile values and principles. The questions that arise are: first, how maturity in agile software development is defined, second, given that the models differ in their proposals and that the path to maturing in the agile software development is still in the process of detection, the question arises – according to which criteria are elements classified into certain levels of maturity; third, what are the advantages and disadvantages of individual models of maturity in agile software development. The aim of the paper is to give an overview of the governing attitudes on a given topic in order the scientific community to be familiar with the current situation in this field, to find answers to the questions asked and to give a comparative presentation of the maturity model in the agile software development, so that IT companies can have insight to offer a model of maturity in an agile environment and to make it easier to make the most suitable model for the circumstances in which their business takes place.

## II. METODOLOGY

The standard methodology of a systematic review of literature recommended by the Institute was applied [2], [11] and [12]. The systematic literature review protocol includes the steps outlined below.

### 1. Defining research questions

The research questions that are considered in this paper are:

RQ1: How is the concept of maturity in agile software development processes defined?

RQ2: What criteria are used in certain models for determining the level of maturity in agile software development?

RQ3: What is the difference between models designed to measure maturity in agile software development?

RQ1 stems from a literature review relevant to the subject, in which it is noticeable that the concept of maturity in agile software development processes is mentioned in the context of developing personal skills rather than the process, however, there is no unambiguous definition of maturity in this domain. Comparative observation of the maturity model in the agile software development notes that each of them has the criteria on the basis of which the organization or team places it at a certain level of maturity. Some models have the same number of levels of maturity, but interpret them differently, and RQ2 refers to this

observation. Namely, models for assessing the maturity of software processes are focused on identifying key steps and improving them, however, not all models are applicable in any situation. Some models require modification or integration with other models to be usable in certain circumstances. Analyzing their similarities and differences comes to RQ3.

### 2. Finding relevant research

The process of searching literature relevant to a given topic was manually conducted in electronic libraries:

- Google Scholar (<https://scholar.google.com/>),
- Kobson (<https://kobson.nb.rs/>) and
- Science Direct (<https://www.sciencedirect.com/>).

The papers were selected first by key words, then by title, abstract, and finally by the conclusion. The key words used to search for papers are: Agile maturity, Software development, Agile methods, Agile software development, Maturity definitions and Agile maturity models. The search for works was carried out according to the key words in English due to the relatively small number of available papers relevant to the topic in the Serbian language.

### 3. Defining criteria for inclusion and exclusion of studies

Studies included in the research were published in the period 2009-2019. Apart from the time period, the criteria that the studies had to satisfy was that they are scientific or review papers published in a scientific journal or conference proceedings. In the first phase of the search, based on the key words, 3,126 papers were found. In the next step, works that are considered relevant for the research topic based on titles were selected and there were 913. The following criterion was related to the selection of papers based on the abstract and 43 studies were selected. According to [2] standard abstracts related to information technology and software engineering are not sufficient to justify on the basis of them whether the study is relevant, and it is necessary to read conclude. Accordingly, after reading the conclusions, 27 relevant studies were selected (Scheme 1).

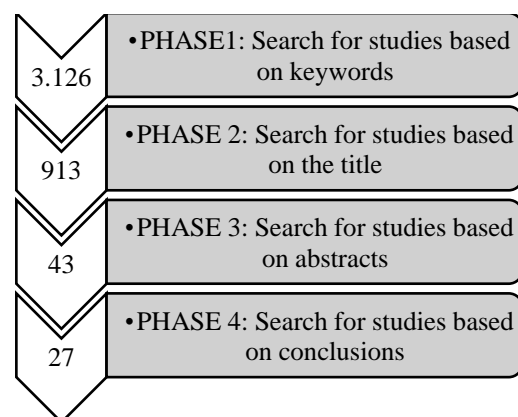

Scheme 1. Phases of the selection process of relevant studies

#### 4. Qualitative evaluation

A systematic literature review is qualitatively assessed using the criteria developed at York University, the Center for Reviews and Dissemination (CDR) Database of Abstracts of Reviews of Effects (DARE). The criteria are based on four questions:

- Are the criteria for inclusion and exclusion of the study described?
- Has the study process covered all relevant studies?
- Is the quality of selected studies evaluated?
- Are basic study data adequately presented?

To be included, the studies had to meet these four criteria.

Evaluation of the quality of the research material in accordance with the defined criteria, as well as the extraction and synthesis of data from the relevant studies, was carried out using the MAXQDA version 2018.2 management software.

### III. RESULTS AND DISCUSSION

Models of maturity are based on the assumptions that people, organizations or areas evolve through the process of development towards greater maturity, going through different levels of maturity. The level in the model of maturity is the base from which evolution can be planned at a higher level of maturity [24]. The goal of the maturity model is to quantify the activities that are currently being implemented and to introduce other activities that will make them mature over time. Models of maturity can generally be divided into three groups: descriptive, prescriptive and comparative models. Descriptive maturity models are diagnostic tools used to describe and evaluate current ability of the subject which is assessed against the set criteria [13]. Prescriptive models of maturity have the proper purpose, identify the preferred levels of maturity, and provide guidelines for improving the current state. Comparative models are used to compare the maturity level of similar business units and organizations and enable benchmarking [22]. Based on the domain, models can be divided into patterns of maturity of processes, objects and people. In addition, models can be grouped at organizational, team level, and personal maturity [14]. Instead of creating their own models of maturity, institutions usually apply some of the existing models of maturity [6]. Maturity in software development is currently defined by the CMMI-DEV and ISO / IEC 15504 models [11].

Capability Maturity Model (CMM) was developed in 1991 by the Software Engineering Institute (SEI) and it is a framework which describes key activities for efficient software development. CMM describes the developmental path of improvement from an unresolved process to a mature disciplined process and includes planning, engineering, software development and maintenance. These key activities enhance the organization's ability to meet cost-related objectives, functionality and product quality [6]. With the integration of CMM into software production, in 2000,

Capability Maturity Model Integration (CMMI) appeared. The main goal of CMMI is to reduce costs in software development processes by eliminating deficiencies and establishing guidelines for helping organizations in different phases of software development [25]. CMMI has five levels of maturity: 1. Initial 2. Managed 3. Defined 4. Quantitatively managed and 5. Optimizing. Processes at the first level of maturity are mostly ad hoc and chaotic. The second level is characterized by processes which manage projects according to plans. At the third level, the processes are well described, understood and standardized in the organization. At the fourth level, organizations establish quantitative goals according to which to manage the projects. The fifth level of maturity involves continuous improvement of the process based on the understanding of goals and needs. In order to reach a certain level, the organization must fulfill all process areas of that level, as well as lower levels [26].

The first model of maturity, which relates to agile software development, was developed by Nawrocki et al. 2001. year. The model was named eXtreme Programming Maturity Model (XPMM) and was created on the basis of the CMMI-DEV model. The goal of the model is to determine whether a particular organization uses XP and to what extent the model is used as a reference point. The model has four levels of maturity: 1. non-compliant, 2. initial, 3. advanced and 4. mature. At the first level of maturity there are organizations or teams which do not apply XP practice in general or apply partially. The second level focuses on teams and defines two areas: relationships with customers and product quality. The third level is focused on coding, and the fourth level refers to the satisfaction of customers and teams. The authors assume that the assessment should not be based on comprehensive documentation in order to respect the principles of the Agile Manifesto [12].

The next model of maturity, that also applies only to XP, was proposed by Lui and Chan in 2005. They developed a model called Road map (RM) whose purpose was to help implement XP into organizations. The authors analyzed the dependencies in XP practices and mapped them into the matrix. The map consists of four phases. In the first phase, testing is carried out, a simple design is established, refactoring is performed, and the coding standard is established. In the second phase, the focus is on continuous integration. In the third phase, implementation of programming is established and collective ownership is established, and in the fourth phase, the remaining XP practices are adopted [12].

Agile Adoption Framework (AAF) was proposed by Sidky et al. 2007. year. This framework consists of two components: an agility assessment index and guidelines for improving the process through 4 phases. Agile Measurement Indices Index (SAMI) defines five levels: 1. collaborative, 2. evolutionary, 3. effective, 4. adaptive and 5. encompassing [14]. Each level is defined in accordance with agile practices and principles to be adopted. The first level focuses on improvements in

communication and collaboration. The second level is aimed at delivering software. The third level is focused on software quality. The fourth level aims to develop the ability to react to changes, and the fifth level is aimed at creating an environment for long-term maintenance of agility. The framework is designed to enable the assessment of agile practices at the project and organization level, as well as providing guidance for the adoption of agile practices.

In 2007, Packlick introduced the Agile Maturity Map (AMM) with the goal of intensifying change, increasing the level of understanding, and the success of execution [14]. AMM includes five levels of maturity that represent different goals that agile teams need to achieve. The goals are: acceptance criteria, successful tests and software construction, iterative planning, learning and adjustment, and engineering expertise. Each goal describes in detail how teams must achieve, and AMM is defined by crossing goals and levels of maturity [17]. AMM has five levels of maturity: 1. awareness, 2. transformation, 3. breakthrough, 4. optimizing and 5. mentoring.

In 2008, Qumer and Henderson-Sellers presented a framework called Agile Software Solution Framework (ASSF), which helps organizations quickly and effectively adopt agile practices. The framework contains the Agile Adoption and Improvement Model (AAIM) model, which directs the software organization to adopt and improve agile practices. The AAIM model has six levels of maturity grouped into three blocks, and for each level of maturity, a set of agile properties and practices is defined. In the first block, level 1 is named agile infancy. The second block includes levels 2. agile initial, 3. agile realization and 4. agile value. The third block consists of the remaining two levels: 5. agile smart and 6. agile progress [17]. The first level of AAIM is focused on the introduction of basic agile properties. At the second level, the focus is on improving communication and cooperation. The third level is presented using executive artefacts and minimal documentation. At the fourth level, an agile basis is established and the focus is on evaluating people. The fifth level is learning-oriented and the sixth level establishes the optimum environment for sustainable agility.

Agile Maturity Model (AMM) was developed by Patel and Ramachandran in 2009. The AMM model is designed to enhance and upgrade agile software development processes and encourage agile principles and goals, such as lower costs, customer satisfaction, software quality, etc. [21]. AMM has the same structure as CMMI. The five levels of maturity of the AMM are: 1. initial, 2. explored, 3. defined, 4. improved and 5. matured. In this model, each level has a predetermined goal defined to help the organization focus on specific improvement activities. At the initial stage of maturity, the software development process is very slow, as organizations do not provide a stable environment for development. The main problems at this level relate to overtime delivery, scheduling, communication, software quality and development costs. Companies at this level of maturity do not have defined agile

practices, they operate in a traditional way and depend on certain individuals, not on the team. Organizations at second maturity have communication problems, coding standards, over time and customer satisfaction. The AMM at second level of maturity aims to help organizations identify and solve problems related to planning, engineering and customer requirements by learning from previous success and failure. At the third level, most technical problems are solved, but organizational problems are not solved. AMM at the third level of maturity aims to help organizations improve client relationships, coding, testing, delivery and coding standards. The fourth level of the AMM model is focused on project management, working hours, team self-organization and risk assessment. This level is more related to improving the team, not the product itself, and it is largely oriented to people and project management practices. The AMM at the fourth level of maturity aims to help organizations respect the people involved in the project and to identify and solve problems related to the functioning of the team. Organizations at the fifth level of maturity continuously improve their processes through quantitative feedback from the processes on the basis of which they form innovative ideas. This level of AMM solves customers and teams satisfaction [21].

Agile Scaling Model (ASM) was developed by Ambler in 2010. ASM is a guideline for adoption and adaptation of agile practices, which consists of three levels. The first level refers to the application of basic agile software development processes, such as, for example, Scrum or eXtreme Programming. At the second level, the focus of the organization is not only on development, but also on the agile delivery of products. At the third level, agile delivery is applied in accordance with the eight scaling factors that cover the complexity of the team's encounter [19].

In 2010 Benefield presented Benefield's Model (BM) for maturity assessment and identification of goals for improving maturity in agile software development processes. This model has seven dimensions that lead to the improvement of agile practices, such as: automatic regression testing, code quality measurement, automatic release into production, automatic construction and configuration management, integration testing, test-based development, performance testing and scalability [17]. These dimensions are implemented through five levels of maturity that determine the extent to which practices are adopted within the team or organization: 1. emergent engineering best practices, 2. continuous practices at the component level, 3. cross component continuous integration, 4. cross journey continuous integration and 5. on demand just in time releases.

Scrum Maturity Model (SMM) developed Yin et al. 2011 with the aim to improve the software development processes based on Scrum. This model provides mechanisms for assessing the maturity of organizations that apply Scrum. SMM has five levels of maturity similar to the CMMI structure [19]. The first level is called initial and implies the absence of goals to improve the process. At the second level, which is

called managed, Scrum practices are structured and complete. At the third level named defined the focus is on customer relations. On the fourth level, called quantitatively managed, there are metrics and process performances. The last level, which is called optimizing, focuses on performance management [17].

AgilityMod (AM) is a meta-model defined by Özcan-Top and Demirors in 2018 in accordance with ISO / IEC 15504. The purpose of using this model is to create a common basis for assessing agility, ensuring better management, and presenting assessment results using a common scale for evaluation [20]. Although AgilityMod has inherited ISO / IEC 15504, it has different names of maturity levels, as well as basic characteristics. AgilityMod has four levels of maturity: 0. non-implemented, 1. ad-hoc, 2. lean and 3. effective. At the zero level, agile practice is either not achieved or is partially achieved. At the first level, development activities such as requirements, design, coding, integration, testing and implementation are implemented consistently. There are attempts to move to agile processes by researching agile practices. This level should be a temporary phase in agile adoption that is characterized as an undisciplined software development environment that partially uses agile practices. The second level name is inspired by the agile principle of simplicity that eliminates processes that do not add value. At this level, the use of agile practices is optimized in terms of software delivery. Products are developed iteratively, which means that frequent feedback from the client allows continuous improvement of product quality. At the third level, the end product value is characterized by high productivity and a small number of deficiencies [20].

An analysis of the model of maturity shows that the models differ in their characteristics. However, at the same time, several similarities were found within these models, which can be partly explained by the fact that authors of the model of maturity build their models without much thought about their suitability. This suggests that the concept of maturity modeling should be re-examined [13]. The lack of XPMM, RM and BM is the fact that these models can be applied only in cases where an organization applies XP, or in the case of SMM Scrum (Table 1). Also, [25] conclude that agility can't be used without the complement of other unadulterated practices. In fact, agile processes often use different targets than CMMI [26]. The challenge is that organizations often rely on CMMI as an indicator of maturity, and agile processes become more and more present. It has been proved that projects using agile processes with certain adjustments can be achieved by CMMI level 2 or 3 [26]. However, reports on successful agile projects have failed to explain how agile processes contribute to meeting the process areas in which they need to be adapted and in which they are in conflict with the objectives of the CMMI. Both CMMI and agile processes have their drawbacks. An analysis of existing projects show that none of them guarantee the success of the project. [28] consider that the use of both approaches in parallel within the same organization or project can increase the probability of success of the project. CMMI and agile processes can mutually neutralize their constraints and lead the software development process to a higher level, which is impossible to achieve when used separately.

TABLE 1. MODELS FOR MEASURING THE MATURITY OF AGILE SOFTWARE DEVELOPMENT PROCESSES

No.	Authors	Model	Maturity level	Purpose
1	Nawrocki and sar. (2001)	eXtreme Programming Maturity Model (XPMM)	4	XP
2	Lui and Chan (2005)	Road map (RM)	4	XP
3	Sidky and sar. (2007)	Agile Adoption Framework (AAF)	5	All agile processes
4	Packlick (2007)	Agile maturity map (AMM)	5	All agile processes
5	Qumer and Henderson-Sellers (2008)	Agile Adoption and Improvement Model (AAIM)	6	All agile processes
6	Patel and Ramachandran (2009)	Agile Maturity Model (AMM)	5	All agile processes
7	Ambler (2010)	Agile Scaling Model (ASM)	3	All agile processes
8	Benfield (2010)	Benfield's Model (BM)	5	XP
9	Yin and sar. (2011)	Scrum Maturity Model (SMM)	5	Scrum
10	Özcan-Top and Demirors (2018)	AgilityMod (AM)	4	All agile processes

Observed models of maturity are focused on assessing the adoption of agile values, principles and practices in an organization or team. The criterion that assigns the organization or team to the first level of maturity is mostly the same in all observed models and is characterized by an environment that is not suitable for the application of agile practices, and agile processes are either partially present or completely absent at this level. Most of the models emphasize the delivery of software, the quality of the end product, and the satisfaction of the team and the client. The highest

levels of maturity in the observed models include an environment that allows continuous and long-term sustainability of agile practices (Table 2). Also, based on the analysis, it can be concluded that agile models of maturity are still in the development phase. A great deal of research is needed to make them fully applicable in practice. Models of maturity should be established on a reasonable conceptual basis, derived from key concepts of agility and successful agile development, and structured with well-defined dimensions, levels, and domain components [14].



**International conference on Applied Internet and Information Technologies  
October 3-4, 2019, Zrenjanin, Republic of Serbia**

TABLE 2. LEVELS OF THE MODEL FOR MEASURING THE MATURITY OF AGILE SOFTWARE DEVELOPMENT PROCESSES

No.	Model	Level 0	Level 1	Level 2	Level 3	Level 4	Level 5	Level 6
1	XPMM	-	<b>non-compliant</b> <i>There are no agile practices</i>	<b>initial</b> <i>Focus on the team</i>	<b>advanced</b> <i>Encryption</i>	<b>mature</b> <i>Focus on customers</i>	-	-
2	RM	-	<b>phase 1</b> <i>Testing</i>	<b>phase 2</b> <i>Integration</i>	<b>phase 3</b> <i>Programming</i>	<b>phase 4</b> <i>Other XP practices</i>	-	-
3	AAF	-	<b>collaborative</b> <i>Communication</i>	<b>evolutionary</b> <i>Software delivery</i>	<b>effective</b> <i>Software quality</i>	<b>adaptive</b> <i>Adapting to changes</i>	<b>encompassing</b> <i>Sustainable agility</i>	-
4	AMM	-	<b>awareness</b>	<b>transformation</b>	<b>breakdown</b>	<b>optimizing</b>	<b>mentoring</b>	-
5	AAIM	-	<b>agile infancy</b> <i>Basic agility properties</i>	<b>agile initial</b> <i>Communication</i>	<b>agile realization</b> <i>Minimize documentation</i>	<b>agile value</b> <i>Focus on the team</i>	<b>agile smart</b> <i>Learning</i>	<b>agile progress</b> <i>Sustainable agility</i>
6	AMM	-	<b>initial</b> <i>There are no agile practices</i>	<b>explored</b> <i>Planning problems</i>	<b>defined</b> <i>Technical problems</i>	<b>improved</b> <i>Focus on customers</i>	<b>mature</b> <i>Focus on the team</i>	-
7	ASM	-	<b>level 1</b> <i>Basic agility properties</i>	<b>level 2</b> <i>Software delivery</i>	<b>Level 3</b> <i>Scaling</i>	-	-	-
8	BM	-	<b>emergent engineering best practices</b>	<b>continuous practices at component level</b>	<b>cross component continuous integration</b>	<b>cross journey continuous integration</b>	<b>on demand just in time releases</b>	-
9	SMM	-	<b>initial</b> <i>There are no agile practices</i>	<b>managed</b> <i>Agile practices are complete</i>	<b>defined</b> <i>Focus on customers</i>	<b>quantitatively managed</b> <i>Focus on processes</i>	<b>optimizing</b> <i>Focus on performance</i>	-
10	AM	<b>not implemented</b> <i>There are no agile practices</i>	<b>ad-hoc</b> <i>Basic agility properties</i>	<b>lean</b> <i>Software delivery</i>	<b>effective</b> <i>Software quality</i>	-	-	-

#### IV. CONCLUSION

Agile processes are becoming more and more popular today and are applied to a large number of projects, both in software development and in the development of other products. Agile processes focus on people, but also provide guidelines for improving software processes. Although most models for measuring the maturity of agile software development processes are derived from the value and principles of the Agile Manifesto, some of them are still under the influence of CMMI and support structured processes. Since 2007 Packlick has begun to introduce more agile principles into software development by defining agile goals. Accent is increasingly being put on the minimization of documentation, informal communication, delivery time of software, product quality, self-organization of the team and satisfied client.

This paper is important for the actors of the software development process that want to be in a state of research in this area. This work will also help the science community involved in software development processes to identify the challenges that this sector faces and to identify areas where research is lacking. Finally, the results will be useful for the software industry seeking solutions in this area.

The disadvantage of this work is the fact that manual search of works in electronic libraries can't include

relevant works in publications that are not indexed. Other sources that are not eligible for protocol execution have not been used.

#### ACKNOWLEDGMENT

Ministry of Education, Science and Technological Development, Republic of Serbia financially supported this research, under the project number TR32044: "The development of software tools for business process analysis and improvement", 2011-2019.

#### REFERENCES

- [1] Alahyari, H., Berntsson Svensson, R., & Gorschek, T., "A study of value in agile software development organizations", *Journal of Systems and Software*, 125, pp. 271–288, 2017.
- [2] Brereton, P., Kitchenham, B. A., Budgen, D., Turner, M., & Khalil, M., "Lessons from applying the systematic literature review process within the software engineering domain", *Journal of Systems and Software*, 80(4), pp. 571–583, 2007.
- [3] Brhel, M., Meth, H., Maedche, A., & Werder, K., "Exploring principles of user-centered agile software development: A literature review", *Information and Software Technology*, 61, pp. 163–181, 2015.
- [4] Chuang, S. W., Luor, T., & Lu, H. P., "Assessment of institutions, scholars, and contributions on agile software development", *Journal of Systems and Software*, 93, pp. 84–101, 2014.
- [5] Estler, H. C., Nordio, M., Furia, C. A., Meyer, B., & Schneider, J., "Agile vs. structured distributed software development: A case study", *Empirical Software Engineering*, 19(5), pp. 1197–1224, 2014.

- [6] Goksen, Y., Cevik, E., & Avunduk, H., "A Case Analysis on the Focus on the Maturity Models and Information Technologies", *Procedia Economics and Finance*, 19(15), pp. 208–216, 2015.
- [7] Henriques, V., & Tanner, M., "A systematic literature review of agile and maturity model research", *Interdisciplinary Journal of Information, Knowledge, and Management*, 12, pp. 53–73, 2017.
- [8] Hoda, R., Salleh, N., Grundy, J., & Tee, H. M., "Systematic literature reviews in agile software development: A tertiary study", *Information and Software Technology*, 85, pp. 60–70, 2017.
- [9] Humble, E., & Russell, R., "The Agile Maturity Model A Releasing Software pplied to Building and Building and Releasing Software", *ThoughtWorks Studios*, 2009.
- [10] Javdani Gandomani, T., & Ziaei Nafchi, M., "An empirically-developed framework for Agile transition and adoption: A Grounded Theory approach", *Journal of Systems and Software*, 107, pp. 204–219, 2015.
- [11] Kitchenham, B., Pearl Brereton, O., Budgen, D., Turner, M., Bailey, J., & Linkman, S., "Systematic literature reviews in software engineering - A systematic literature review", *Information and Software Technology*, 51(1), pp. 7–15, 2009.
- [12] Kitchenham, B., Pretorius, R., Budgen, D., Brereton, O. P., Turner, M., Niazi, M., & Linkman, S., "Systematic literature reviews in software engineering-A tertiary study", *Information and Software Technology*, 52(8), pp. 792–805, 2010.
- [13] Kohlegger, M., Maier, R., & Thalmann, S., "Understanding maturity models results of a structured content analysis", *Proceedings of I-KNOW '09 and I-SEMANTICS '09*, pp. 51–61, 2009.
- [14] Leppanen, M., "A Comparative Analysis of Agile Maturity Models", *Information Systems Development*, 2013.
- [15] Maier, A. M., Moultrie, J., & Clarkson, P. J., "Assessing organizational capabilities: Reviewing and guiding the development of maturity grids", *IEEE Transactions on Engineering Management*, 59(1), pp. 138–159, 2012.
- [16] Mantovani Fontana, R., Mantovani Fontana, I., Da Rosa Garbuio, P. A., Reinehr, S., & Malucelli, A., "Processes versus people: How should agile software development maturity be defined?", *Journal of Systems and Software*, 2014.
- [17] Mantovani Fontana, R., Meyer Jr., V., Reinehra, S., & Malucelli, A., "Progressive Outcomes: A framework for maturing in agile software development", *The Journal of Systems and Software*, 2015.
- [18] Matkovic, P., Maric, M., Tumbas, P., & Sakal, M., "Traditionalisation of agile processes: Architectural aspects", *Computer Science and Information Systems*, 15(1), pp. 79–109, 2017.
- [19] Ozcan-top, O., & Demirörs, O., "Assessment of Agile Maturity Models: A Multiple Case Study", *CCIS*, 2013.
- [20] Özcan-Top, Ö., & Demirors, O., "Application of a software agility assessment model – AgilityMod in the field", *Computer Standards and Interfaces*, 62, pp. 1–16, 2018.
- [21] Patel, C., & Ramachandran, M., "Agile maturity model (AMM): A Software Process Improvement framework for agile software development practices", *Int. J. of Software Engineering*, 2009.
- [22] Pöppelbuß, J., & Röglinger, M., "What Makes a useful maturity model? A framework of general design principles for maturity models and its demonstration in business process management", *Ecis*, Paper28, June 2011.
- [23] Rönkkö, M., Peltonen, J., & Frühwirth, C., "Examining the effects of agile methods and process maturity on software product development performance", *Lecture Notes in Business Information Processing*, 2011.
- [24] Santos, R. S., Borges, M. R. S., Canós, J. H., & Gomes, J. O., "The Assessment of Information Technology Maturity in Emergency Response Organizations", *Group Decision and Negotiation*, 20(5), pp. 593–613, 2011.
- [25] Selleri Silva, F., Soares, F. S. F., Peres, A. L., Azevedo, I. M. De, Vasconcelos, A. P. L. F., Kamei, F. K., & Meira, S. R. D. L., "Using CMMI together with agile software development: A systematic review", *Information and Software Technology*, 58, pp. 20–43, 2015.
- [26] Therese, C., & Alagarsamy, K., "Extreme Programming versus CMMI – Conflicts and Compatibilities", *Analysis*, 1(5), pp. 203–209, 2011.
- [27] Torrecilla-Salinas, C. J., Sedeño, J., Escalona, M. J., & Mejias, M., "Agile, Web Engineering and Capability Maturity Model Integration: A systematic literature review", *Information and Software Technology*, 71, pp. 92–107, 2016.
- [28] Ziółkowski, A., & Deręgowski, T., "Hybrid Approach in Project Management – Mixing Capability Maturity Model Integration with Agile Practices", *Social Sciences*, 85(3), pp. 64–71, 2014.

# Data Quality Assessment

V. Erceg<sup>1</sup>, L. Šereš<sup>2</sup>, T. Zoranović<sup>3</sup>

<sup>1</sup> PhD student, University of Novi Sad, Faculty of Economics, Subotica, Segedinski put 9-11, 24000, Subotica, Serbia

<sup>2</sup> University of Novi Sad, Faculty of Economics, Subotica, Segedinski put 9-11, 24000, Subotica, Serbia

<sup>3</sup> University of Novi Sad, Faculty of Agriculture, Trg Dositeja Obradovića 8, 21101 Novi Sad, Serbia  
vanja.erceg@gmail.com, laslo.seres@ef.uns.ac.rs, tihomir@polj.uns.ac.rs

**Abstract** - The digital age has allowed the relatively rapid circulation of large amounts of data. Concretized data presented in the form of information is the basis of business decision making, and the quality of business decision is directly correlated with the quality of data. The aim of this paper is to find the answer to the question of how data quality is defined, what characteristics data should have in order to be considered quality, and how data quality can be measured. The paper provides a systematic review of the scientific and professional literature relevant to a given topic in order to gain insight into current reflections and prevailing attitudes, that is, find answers to the questions raised. 19 studies relevant to the topic were identified, a proposal for a definition of data quality was provided, as well as an overview of the principles and metrics available for measuring data quality. The paper contributes to the knowledge of data quality management as well as the evaluation of data quality by providing an overview of the existing literature in this field and provides recommendations for improving the quality of data for companies wishing to achieve a competitive market position.

## I. INTRODUCTION

The terms data and information are often used in the literature as synonyms. However, in management structures, data and information are treated differently. Specifically, information is considered to be processed data that has a specific value at a certain point in time. Data and information will be used interchangeably in the paper, since the cited authors interpret these concepts differently.

"To maximize productivity, organizations need to manage information, such as managing products" [17]. The quote above emphasizes the importance and necessity of managing the data quality. Data quality management encompasses activities from data collection through to distribution and aims at maintaining high quality of information. Effective data quality management is a prerequisite for consistent data analysis, which will give a realistic picture of the data state that the organization has at its disposal. Data quality management prepares an organization to face the challenges in the digital age, because improving data quality can be a significant source of competitive advantage, while poor data quality can be critical to the success of individual organizations [16]. Modern information technologies with the concept of databases provide the opportunity to build a modern decision

support system and provide quality information for business management [4].

Data quality is defined in the literature as being appropriate to use or meet user needs [14]. To answer the question of how good data quality is in an organization, data quality metrics are needed. Studies have confirmed that data quality is a multidimensional concept. Specifically, organizations must consider both the subjective perceptions of individuals involved in the collection and use of data, as well as objective conditions. Subjective assessments of data quality represent the needs and experiences of stakeholders. Failure by stakeholders to assess the data quality may affect their behavior. Objective assessments can be task independent or task dependent. Task-independent metrics represent data states without contextual knowledge and can be applied to any data set. Task-dependent metrics include the organization's business rules, regulations, and constraints, and evolve in specific contexts [10]. Today, most of the company's operations and strategic decisions rely heavily on data, so the importance of data quality is extremely high.

Namely, poor data quality is the leading cause of business failure [3]. There are several sources of poor data quality, such as mergers and acquisitions of business systems, use of legacy systems, and user errors. When merging two organizations or taking over one organization by another, their databases are necessarily merged. It is very possible for companies to use completely different data systems, that one has a database of outdated information and the other regularly updates the data. Also, there is a possibility for organizations to use different methods of data collection or one organization has a lot of wrong data. The solution in these situations may be to establish a new matrix that will clearly define the rules. Some organizations use legacy systems for their databases, and there may be a number of problems due to the technical nature of the database itself. When using legacy systems, although technically correct, the data may be useless for practical purposes. In order to avoid this problem, it is essential that there is a transition team that is well-versed in both systems in order to make the transition adequately. The problem of user errors stems from the fact that people will always be involved in data entry and that people make mistakes. In order to minimize this occurrence, it is necessary to have a team in charge of cleaning up the database and correcting

incorrect entries. It is also recommended to use as simple data entry forms as possible to minimize the possibility of error.

Due to technological advances in the twenty-first century, the amount of data generated is doubling every year. [12] argue that technologies such as cloud computing, the Internet of Things (IoT), and social networks mark the beginning of the Big Data era. By quickly collecting and analyzing big data from different sources and for different purposes, researchers and decision makers have realized that this vast amount of information contributes to understanding clients' needs, improving service quality and anticipating and preventing risks. However, for the use and analysis of big data to generate value, it must be based on accurate and high data quality [20]. Therefore, assessing data quality can be a good starting point for identifying insignificant information.

Compared to traditional data, the characteristics of big data are: huge volume, great variety, low credibility and great value. The major difficulty in manipulating big data is not only their sheer volume, as this issue can be somewhat mitigated by the expansion of databases and the improvement of computer systems [5]. In fact, the real challenges concern different types of data, requests for timely submission of data, and falsehoods in the data. Due to the diverse types of data, data management applications often have to deal not only with traditional structured data, but also with semi-structured or unstructured data, such as text, images, video, etc. Timely responses are also a challenge as there is a possibility that a sufficient amount of resources to collect, store and process big data is not available. Finally, difference between true and false or reliable and unreliable data is especially challenging, even for the best methods of data cleansing, as data entry is done by a great number of users [7].

## II. METODOLOGY

The standard methodology of systematic literature review recommended by [2], [8] and [9] was applied in the paper. The following are the mandatory steps required by the systematic literature review protocol.

### 1. Defining research questions

The research questions under consideration are:

RQ1: How is data quality defined?

RQ2: What characteristics does the data consider to be of good quality?

RQ3: How can data quality be measured?

An analysis of the existing literature and definitions has revealed that a generally recognized definition of data quality does not exist, and RQ1 is set up with the aim of proposing a unified definition of data quality. Various authors have outlined the characteristics and principles that data must fulfill in order to be considered quality, and RQ2 is set up to gain insight into a specific list of requirements. Management teams often ask questions about the data quality, whether it is of sufficient quality to make important decisions and

whether it is possible to raise the data to a higher level of quality, and RQ3 is formulated on this basis.

### 2. Finding relevant research

The process of searching for literature relevant to the topic was performed manually in electronic libraries:

- Google Scholar (<https://scholar.google.com/>) and
- Kobson (<https://kobson.nb.rs/>).

The papers were selected first by keywords, then by title, then abstract and finally by conclusion. The keywords used for the search of papers were: data quality, data quality management, data quality assessment and big data. The search of papers was performed according to keywords in English because of the relatively small number of available papers relevant to the topic in Serbian.

### 3. Defining criteria for inclusion and exclusion of studies

The studies included in the study were published in the period 2015-2019. In addition to the time period, the criterion that the studies had to satisfy was that scientific or review papers were published in a scientific journal or conference proceedings. In the first keyword search phase 1125 papers were found. In the next step, papers that were considered relevant to the research topic were selected based on the title and there were 511. The next criterion concerned the selection of works based on the abstract and 32 studies were selected. According to [2] standard abstracts related to information technology and software engineering are not sufficient to make conclusion whether the study is relevant or not, so it is necessary to read the conclusions. Accordingly, 19 relevant studies were selected after reading the conclusions (Scheme 1.)

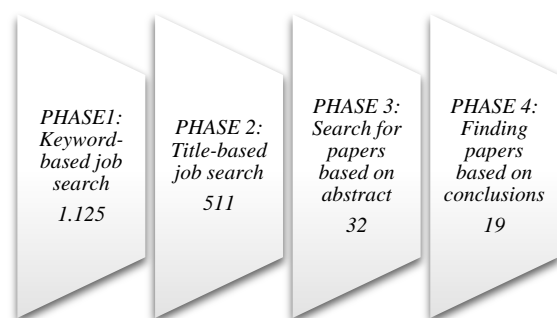

Scheme 1. Phases of the selection process of relevant studies

### 4. Qualitative evaluation

A systematic review of the literature was qualitatively assessed using criteria developed at the York University, Center for Reviews and Dissemination (CDR) Database of Abstracts of Reviews of Effects (DARE). The criteria is based on four questions:

- Is the criteria for study inclusions and exclusions described?
- Does the study request process cover all relevant studies?

- Is the quality of the chosen studies assessed?
- Are basic study data adequately presented?

To be included, studies have to meet all four criteria.

The evaluation of the quality of the research material according to the defined criteria, as well as the extraction and synthesis of data from relevant studies, was performed using the qualitative data management software MAXQDA version 2018.2.

### III. RESULTS AND DISCUSSION

Data quality assessment is a special phase in the data life cycle that is used to verify the source, quantity and impact of any data that violates predefined data quality rules. Data quality assessment is usually performed by dedicated software for measuring data quality. Closely related to data quality assessment is the practice of defining and assessing data quality dimensions. These are different sets of rules or categories that can provide a comparative analysis of the level of data quality across different tables, systems, business functions, or organizations.

According to [11] the dimensions of data quality are: accuracy, consistency, completeness, integrity, and timeliness. Accuracy refers to real-time business transactions and should be measured through original

documentation, or, if not available, then by an independent, validation technique. A typical metric for measuring accuracy is the data-to-error ratio, which tracks the amount of errors with respect to the data set. Consistency is that two values drawn from separate data set must not conflict with each other. However, consistency does not automatically imply accuracy. For example, the sum of products sold in each affiliate of one organization must not exceed the total number of products sold in that organization. Completeness indicates whether there is sufficient information to draw conclusions. Completeness can be measured by determining whether each data entry is complete. All available data entry fields must be filled in to avoid missing relevant data set. A simple quality metric that can be used is the number of blank values within a data set. Integrity refers to the structural testing of data to ensure that data is in accordance with procedures. This dimension is measured by the rate of data transformation errors. Timeliness refers to the timely availability of information. In other words, it measures the time between when data is needed and when data is available for use. The timeliness metric is the time-value of the data (Table 1). The best time to collect valuable data is as soon as possible.

TABLE 1. DIMENSIONS AND METRICS OF DATA QUALITY

Dimension	Dimension description	Metrics
Accuracy	The information obtained from the data corresponds to reality.	Ratio of data to errors
Consistency	There are no contradictions between the data in the database.	Number of inconsistencies
Completeness	All data is available in the database.	Number of blank values
Integrity	The data entered in the database have the required format and structure.	Data transformation error rate
Timeliness	The data refers to a time period in accordance with the standards of the organization.	Data time-to-value

In addition to the above characteristics, different authors cite other dimensions of data quality. According to [10] the dimensions of data quality are: accessibility, appropriate amount of data, credibility, completeness, concise representation, ease of manipulation, no error, interpretability, objectivity, relevance, reputation, security, timeliness, intelligibility and value. Data quality can also be measured against the following dimensions: consistency, accuracy, completeness, audibility, orderliness, uniqueness and timeliness [13]. [19] highlight the following dimensions of data quality: lack of error, objectivity, reputation, credibility, relevance, value, timeliness, completeness, appropriate amount of data, interpretability, intelligibility, consistent representation, concise representation, ease of handling and security of access.

Experience has shown that the one-size-fits-all principle is not suitable for measuring data quality. Namely, in order to make objective assessments,

organizations should comply to certain principles and develop metrics specific to their needs. Often the most difficult task is to define dimensions accurately, while formulating metrics is much easier when this task is completed [10]. [11] lists the following data quality metrics:

- Ratio of data to errors: tracks the number of known errors in the data over the entire data set. If the size of the data grows or stagnates and the number of errors decreases, the data quality increases.
- Number of blank values: counts the number of times an empty field appears within a data set. If the number of blank fields decreases, the data quality increases.
- Data time-to-value: estimates how long it takes to retrieve the requested data from a data set.
- Data transformation error rate: monitors how often the data transformation operation fails. Data

transformation involves downloading data stored in one format and converting it to another format.

- Data storage costs: when storage costs increase and the amount of data used remains the same or decreases, it can mean that a significant part of the stored data is of low quality. Conversely, if storage costs decline while the amount of data remains the same or increases, the data quality improves.
- Amount of dark data: dark data is data that cannot be used effectively due to quality issues.

For structured data, the data quality literature proposes several algorithms for estimating their dimensions, while big data presents new challenges related to their specific characteristics [11]. When measuring the quality of big data the following dimensions emerge: availability, utility, reliability, relevance, and presentation quality [20]. According to [6], the characteristics that big data must fulfill in order to be considered quality are: consistency, accuracy, completeness, audibility and orderliness. Namely, for “mass data” not all of the above characteristics are fully achievable, as there are certain specifics of quality management of big data. For big data there must be logical relationships within the databases, because linking data from different sets requires a certain level of consistency. In terms of accuracy, its level varies from task to task. If the information from the previous month is to be analyzed and the data from the previous three days is not available, a precise number cannot be calculated. If sophisticated calculations or detailed historical records are required, the lack of individual data may lead to wrong decisions. Also, ensuring consistency and accuracy of data is a challenge for “mass data” because data is often changed and shared with multiple contributors [18]. Completeness is not entirely feasible because big data naturally comes with many gaps. However, regardless of the blank fields, it is possible to obtain relatively adequate analysis results due to the huge amount of other similar data. The whole picture will still be adequate even without a small piece of data. Due to the complexity and heterogeneity of the big data dimensions, accuracy and completeness seem difficult. For example, data on social networks are highly distorted in space, time, and demographics, and location accuracy varies from a few meters to several hundred kilometers [18]. Big data provides the ability to audit. It takes a lot of time and resources to audit, but organizations can then determine the exact quality of their data. As for neatness in big data, there is a certain degree of “controlled chaos” among the data. However, before data is loaded into big data repositories, they are usually subjected to a cleanup process, which can partially ensure the orderliness of the data.

Making good decisions requires an appropriate quality assessment method for “mass data”. [20] propose a data quality assessment method with a dynamic feedback mechanism based on the characteristics of big data. The first step of the assessment process is to determine the data collection targets. Specifically, Big Data users rationally choose the data to use in accordance with their strategic goals or business requirements. In order to further evaluate quality, a separate evaluation indicator must be

selected for each dimension. Each dimension of quality requires different tools, techniques, and measurement processes, leading to differences in the resources required for evaluation. Once the quality assessment preparation is completed, the process enters the data collection phase. In the age of big data, data collection is relatively easy, but much of the data collected can be of low quality [15]. This is why data is cleaned up to detect and remove errors and inconsistencies from the data in order to improve their quality. The process then enters the data quality assessment phase. The essence of data quality assessment is to evaluate each quality dimension. After the assessment, the data are compared with the established data quality standard. If the data quality matches the standard, a data analysis phase can be initiated and a data quality report generated. Otherwise, if the data quality does not meet the standard, it is necessary to collect new higher data quality [20].

#### IV. CONCLUSION

Data quality management is a key process for maintaining a competitive position in the market, because the quality of business decisions depends directly on the quality of the information. Poor data quality can lead to low data efficiency and consequently serious decision making errors, which can subsequently lead to irreversible losses.

The research analyzed the definitions of data quality, outlined the process of data quality assessment, outlined the dimensions of data quality and the available metrics for measuring data quality. Also, the paper analyzes the specifics of quality management of big data and presents the process of quality assessment of big data with feedback mechanism. This paper may be a potential starting point for developing improved insights into the aspects of research considered. Also, the contribution of this paper is reflected in the presentation of important implications that emerge from the use of business value from data and indicates the need for additional research on big data management.

#### ACKNOWLEDGMENT

Ministry of Education, Science and Technological Development, Republic of Serbia financially supported this research, under the project number TR32044: “The development of software tools for business process analysis and improvement”, 2011-2019.

#### REFERENCES

- [1] Ardagna, D., Cappiello, C., Samá, W., & Vitali, M., “Context-aware data quality assessment for big data”, *Future Generation Computer Systems*, 89, pp. 548–562, 2018.
- [2] Brereton, P., Kitchenham, B. A., Budgen, D., Turner, M., & Khalil, M., “Lessons from applying the systematic literature review process within the software engineering domain”, *Journal of Systems and Software*, 80(4), pp. 571–583, 2007.
- [3] Čavalić, A., “Utjecaj Kvalitete Podataka I Informacija Na Kvalitetu Odluke”, *Ekonomika Misao i Praksa*, (2), pp. 495–513, 2016.
- [4] Čurko, K., “Skladište podataka - sustav za potporu odlučivanju”, pp. 840–855, 2001.
- [5] Fosso Wamba, S., Akter, S., Edwards, A., Chopin, G., & Gnanzou, D., “How ‘big data’ can make big impact: Findings from a systematic review and a longitudinal case study”, *International Journal of Production Economics*, 165, pp. 234–246, 2015.

- [6] Janssen, M., van der Voort, H., & Wahyudi, A., "Factors influencing big data decision-making quality", *Journal of Business Research*, 70, pp. 338–345, 2017.
- [7] Jin, X., Wah, B. W., Cheng, X., & Wang, Y., "Significance and Challenges of Big Data Research", *Big Data Research*, 2(2), pp. 59–64, 2015.
- [8] Kitchenham, B., Pearl Brereton, O., Budgen, D., Turner, M., Bailey, J., & Linkman, S., "Systematic literature reviews in software engineering - A systematic literature review", *Information and Software Technology*, 51(1), pp. 7–15, 2009.
- [9] Kitchenham, B., Pretorius, R., Budgen, D., Brereton, O. P., Turner, M., Niazi, M., & Linkman, S., "Systematic literature reviews in software engineering-A tertiary study", *Information and Software Technology*, 52(8), pp. 792–805, 2010.
- [10] Kulikowski, J. L., "Data Quality Assessment", *International Journal of Organizational and Collective Intelligence*, 4(1), 24–36, 2014.
- [11] Lebed, M., "The Ultimate Guide to Modern Data Quality Management (DQM) For An Effective Data Quality Control Driven by The Right Metrics", *Datapine*, 2018.
- [12] Mishra, D., Luo, Z., Jiang, S., Papadopoulos, T., & Dubey, R., "A bibliographic study on big data: concepts, trends and challenges", 2017.
- [13] Otto, B., "Quality and Value of the Data Resource in Large Enterprises", *Information Systems Management*, 32(3), pp. 234–251, 2015.
- [14] Taleb, I., Serhani, M. A., & Dssouli, R., "Big Data Quality: A Survey", *Proceedings - 2018 IEEE International Congress on Big Data, BigData Congress 2018 - Part of the 2018 IEEE World Congress on Services*, pp. 166–173, 2018.
- [15] Tsai, C. W., Lai, C. F., Chao, H. C., & Vasilakos, A. V., "Big data analytics: a survey", *Journal of Big Data*, 2(1), pp. 1–32, 2015.
- [16] Vuk, D., Ciriković, E., & Suk, D., "Kvaliteta podataka i njen značaj danas", *VI*, pp. 54–58, 2015.
- [17] Wang, R. Y., "Total Data Quality Management", *Communications of the ACM*, 41(2), pp. 58–65, 1998.
- [18] Yang, C., Huang, Q., Li, Z., Liu, K., & Hu, F., "Big Data and cloud computing: innovation opportunities and challenges", *International Journal of Digital Earth*, 10(1), pp. 13–53, 2017.
- [19] Zhu, H., Madnick, S., Lee, Y., & Wang, R., "Data and Information Quality Research", *Computing Handbook, Third Edition*, 2014.
- [20] Zhu, Y., & Cai, L., "The Challenges of Data Quality and Data Quality Assessment in the Big Data Era", *Data Science Journal*, 14(2), pp. 1–10, 2015.

# E-Learning in Higher Education – An Overview of Strategic Planning

D.Zlatković\*, N. Denić\*\* and M. Petrović\*\*

\* Alfa BK University/Faculty of Mathematics and Computer Sciences, Belgrade, Republic of Serbia

\*\* University of Pristina/Faculty of Natural Sciences, Kosovska Mitrovica, Republic of Serbia  
dragan.zlatkovic@alfa.edu.rs; nebojsa.denic@pr.ac.rs; milena.petrovic@pr.ac.rs;

**Abstract - Implementation of E-Learning is one of the ways of applying modern information technologies to achieve a high quality of higher education. The transition of higher education institutions towards E-Learning should be an integral part of strategic planning that seeks to change and improve the work of universities. This paper explains the importance of systematic implementation of E-Learning in higher education institutions. The article analyzes internal strengths and weaknesses, as well as external opportunities and threats of E-Learning through SWOT analysis. The paper also describes the problems and challenges of introducing E-Learning at different levels in higher education and provides some of the existing recommendations for addressing these issues and challenges. It also provides an overview of significant research on strategic approach and decision making in the introduction of E-Learning in higher education. It is highlighted the importance of the strategic plan in the process of introducing E-Learning in higher education institutions. Also, the study gives an insight into the current situation in higher education concerning the implementation of E-Learning and on the current “bottom-up” approach applicable in the process of introduction of E-Learning in higher education institutions.**

## I. INTRODUCTION

Computerization has become a part of daily life and communication, with improvements in almost every area and creation of a unique global market for information and technology. The high-quality and well-designed application of information and communication technologies (ICT) has made significant progress in the educational process, improved the quality of learning and teaching, and increased the availability of knowledge. The introduction of E-Learning as one way of applying modern information technology has created a stimulating and positive climate for many changes in education, so E-Learning can reasonably be called a catalyst for change in higher education.

The importance of introducing E-Learning in higher education institutions and its benefits, as well as the problems and challenges of introducing E-Learning in higher education, are described in Chapters I, II, and III. An overview of necessary E-Learning research on the importance of a strategic approach of its implementation in higher education is given in Chapter IV.

## II. RESEARCH METHODOLOGY

The research methodology through content analysis is devised to reach a valid conclusion:

- Carry out an in-depth literature study to develop relevant knowledge about strategic planning for E-Learning.

## III. LITERATURE REVIEW

### A. Definition and Importance of eLearning

E-Learning is quite tricky to define unequivocally. Some authors consider E-Learning as exclusively a form of learning that is entirely online or so-called “pure” E-Learning which is a form of teaching whereby students learn entirely independently and online [1,2], while others find E-Learning as so-called mixed or hybrid education, which is a combination of classical classroom teaching and ICT-based teaching [3]. E-Learning as a form of teaching exists at several levels: as a fully independent form, but also as an integral part or complement to classical education. Therefore, the definitions of E-Learning by different authors also differ.

Obringer and Hawkins [1] claim that learning can be considered E-Learning if the entire course is online and if all interaction between tutors and students takes place online.

As per definition of American Association ASTD dated in 2001 E-Learning is a methodology by which "teaching content or learning experiences delivered or enabled by electronic technology." [4].

The most commonly cited E-Learning definition is the definition of T. Bates [3], who says that E-Learning includes all computer and online activities that support learning and teaching inside/outside the classroom.

The importance of E-Learning is excellent in terms of improving the quality of education at universities and improving the results of the educational process. E-Learning makes a significant contribution to the day-to-day organization of the educational process, the flexibility of time and space in teaching and learning, and the unlimited availability of knowledge and teaching content. E-Learning facilitates better and more accessible



communication between tutors and students and encourages them to cooperate more actively. Education becomes available to students in remote locations, students with disabilities and international students, making E-Learning more accessible to education and increasing the percentage of highly educated staff.

E-Learning also enhances the results of the educational process by creating quality professionals with lifelong learning and ICT-specific skills [5].

The importance of E-Learning must also be seen in terms of improving the quality of the teaching process. E-Learning, like other forms of ICT supported learning, can increase the quality of teaching content, allowing students to solve problems and make their own decisions. Quality of teaching and learning contents implies student satisfaction with the quality of all segments of teaching: the way of transfer of knowledge, the credibility of tutors, the availability and adoption of content and the ability to seek, analyze and interpret information [5].

European Association for Quality Assurance in Higher Education (ENQA), European Association for Quality Assurance in Higher Education (ENQA) European Students' Union (ESU), European University Association (EUA), European Association of Institutions in Higher Education (EURASHE) were in 2015 in cooperation with Education International (EI), BUSINESSEUROPE and the European Quality Assurance Register for Higher Education (EQAR) has published recommendations called "Standards and Guidelines for QA in the European Higher Education Area" [6]. The standards and guidelines are divided into three parts. The first part deals with quality assurance in higher education institutions, the second with external evaluations, and the third with accreditation agencies.

The introduction of E-Learning can also reduce the consequences of the phenomena that are often the result of the uncontrolled spread of higher education: increased teaching responsibilities, increasing the number of students, lack of time for scientific work, hiring inexperienced teaching staff, and a lack of interaction between students and professors.

E-Learning significantly improves communication in the educational process. Interactivity and communication are different in E-Learning compared to classroom teaching. The interaction between students and teachers in the classroom is direct F2F, which of course has a significant advantage, but the trend of increasing the number of students is recognized, resulting in the so-called mass study. E-Learning provides an individual approach of tutors towards students and provides feedback.

The implementation of E-Learning can also improve the cost-effectiveness of investing in higher education in several ways: it enables the institution to reach more diverse students, reduce and/or abolish certain activities performed by tutors that ICT would play (thus freeing tutors time to have a more productive activities) and

increase the quality of learning, either empower students to achieve better results and to learn new skills, or to enable them to achieve their existing goals faster and easier.

The activity, motivation, and self-discipline of individuals are key motivating factors for successful teaching. E-Learning guarantees success only for highly motivated students since students who study exclusively online are more often susceptible to dropout [7]. The availability and adaptability of education and the trend of lifelong learning provide the opportunity to make learning an essential part of a person's entire lifespan. E-Learning is an ideal solution for users of the educational system, as it allows for self-organizing time and physical dislocation.

### *B. Problems. and Challenges of Introducing E-Learning in Higher Education*

In the last thirty years, many universities have integrated some of the forms of E-Learning into student learning and teaching processes. Despite the benefits of introducing E-Learning, the problem is related to how E-Learning is implemented, and that is the so-called "bottom-up" approach that avoids strategic planning for the introduction of E-Learning in higher education. The implementation of E-Learning was done without a strategic plan and without creating the necessary preconditions for the strategic introduction of E-Learning into the existing practice and institutional structure of the university [8].

The introduction of E-Learning in higher education was more of an evolution than a revolution [9], in which the so-called freelance shooters unsuccessfully tried to start a revolution. Freelance shooters were the teachers who develop ICT-supported teaching materials for a small amount of fee [10].

Today, higher education has become part of a global movement towards a new way of creating and using knowledge. The new route is focused on problem-solving, sensitive to user needs, making significant progress in quality and quantity, and crossing the boundaries on the road to interdisciplinarity.

Today's situation shows the progress of higher education institutions, with more and more higher education institutions moving from the initialization phase to the implementation phase and even to the institutionalization phase. Collis and Van der Wende [11] state that for fully institutionalize of ICT a robust technological infrastructure should be established in pedagogically ways and develop a strategic plan for the implementation of ICT and E-Learning in higher education.

### *C. SWOT Analysis*

The analysis of strengths and weaknesses, opportunities, and threats in the introduction of E-Learning was carried out within the framework of the SWOT analysis [9], [12-19] (Figures 1-4).

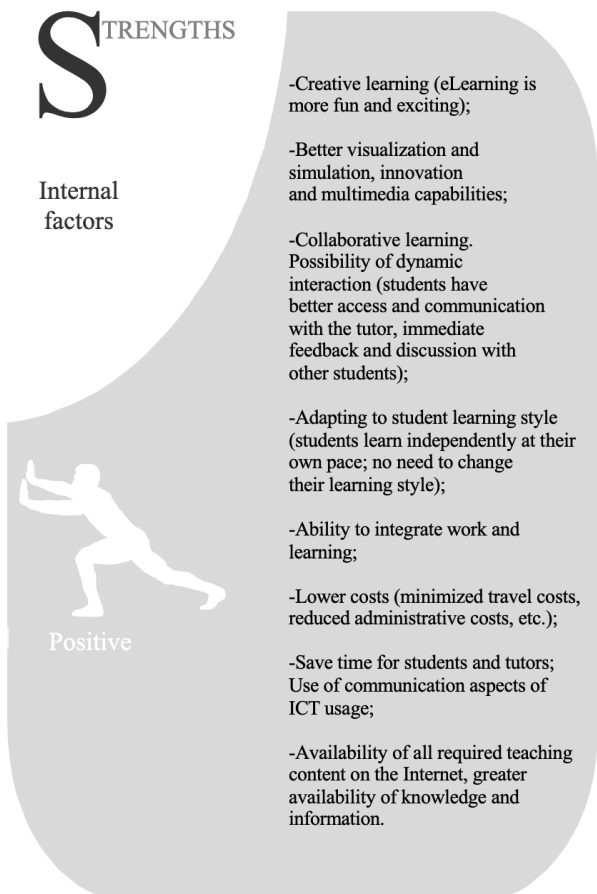

Figure 1. SWOT Analysis – Strengths internal factors

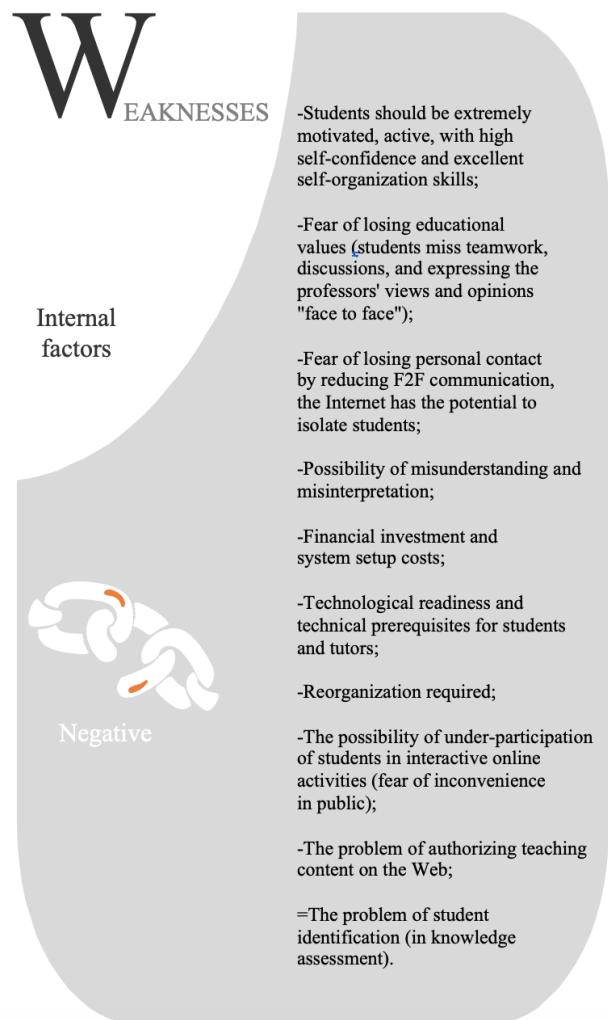

Figure 3. SWOT Analysis – Weaknesses factors

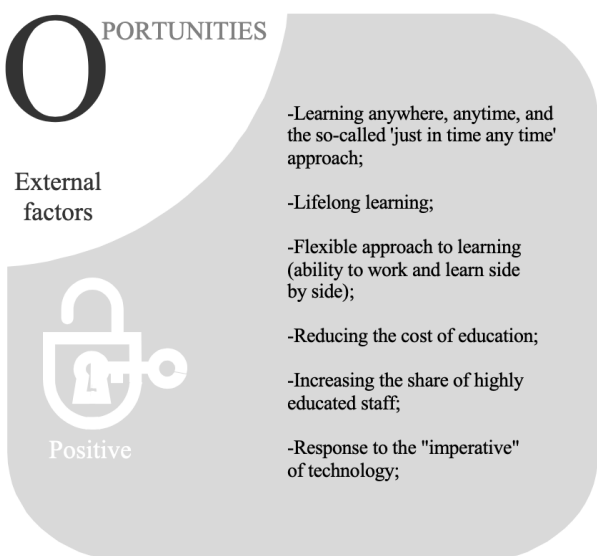

Figure 2. SWOT Analysis – Opportunities factors



Figure 4. SWOT Analysis – Threats factors

SWOT analysis is a means of systematically analyzing the relationship between internal strengths (S) and weaknesses (W) and external opportunities (O) and threats (T) [20].

#### IV. OVERVIEW OF SIGNIFICANT RESEARCH ON STRATEGIC APPROACH IN INTRODUCING OF E-LEARNING IN HIGHER EDUCATION

Strategic planning for the introduction of E-Learning in higher education has been the subject of interest of many researchers [21]. The implementation of multi-criteria decisions in the strategic plan for the introduction of E-Learning is new and unexplored.

Below are some of the more critical research related to strategic planning for the introduction of E-Learning in higher education.

In 1997, Wills and Yetton [22] pursued a strategic approach to the introduction of ICT and sought to classify strategies for the introduction of ICT in higher education. They analyzed the process of introducing ICT concerning the procedure, knowledge and skills, management processes, and structure of the institution. Twenty universities participated in the survey, and the strategies they identified as the three core ones in introducing ICT into higher education:

- a value-added approach,
- a cost-based plan, and
- a hybrid strategy.

Toni Bates [23], in 2000, published a book on leadership strategies at the university called "Managing technology change: strategies for college and university leaders," which made a series of recommendations for making strategic decisions and managing the university as successful as possible. The author answers questions about what needs to be done to ensure the successful and financially sustainable implementation of new technologies by reorganizing, restructuring, or reengineering universities and colleges. The results of his research include numerous planning and management strategies and organizational strategies for the introduction of new technologies. Bates also outlines the possible implications of university restructuring. The same author published the results of his research in the publication "National strategies for E-Learning in post-secondary education and training" [24], aimed at experts in strategic planning in education and government officials and politicians who need to understand strategic planning in education and successfully link it to national development.

Howell et al. [25], in their paper "Thirty-two trends affecting distance education," cite 32 trends that influence the strategic planning of the introduction of E-Learning. The authors believe that the long-term demographic and economic projections that strategic planning often relies on are not sufficient to successfully plan for the introduction of E-Learning, and have

identified trends related to technology advancements, learning styles, tutors and student responses, tensions between administrative support, teaching staff and management of higher education institutions, organizational culture, etc. Trends are organized into several categories: student-related trends, faculty trends, academic trends, technology trends, economic trends, distance learning trends, and vision-related trends. All trends have been identified based on a comprehensive literature review in the field of E-Learning and have been defined with the aim of assisting decision-makers in strategic planning and decision-making on the introduction of E-Learning in higher education institutions.

Curran [2], in his research, analyzes E-Learning strategies of different universities from the following three perspectives: greater access to education, higher quality of learning and teaching, and reduced costs of education. Case studies were conducted at European and American universities.

Aczel et al. [25] conducted a significant study whose results were presented at the 4<sup>th</sup> EDEN research workshop held in Barcelona in 2006. In their research, the authors answered two fundamental questions:

- How can innovations in E-Learning strategies of higher education institutions be identified?
- What are the critical success factors for E-Learning strategies?

The study was conducted at 25 higher education institutions. The results showed that most institutions have a hybrid learning application, and only a small number of institutions have formally adopted a strategic document for the introduction of E-Learning. According to them, the critical success factors include:

- Business plan,
- Quality management process,
- Student support center, and
- Technology that is robust, accessible, and easy to use with adequate technical support.

Petra Boezeroy [19], in her doctoral dissertation "E-Learning strategies of higher education institutions," deals with identifying the differences between higher education institutions concerning the strategic approach they use in integrating new technologies into education and technical and administrative support. The results of her research showed that the main advantage of E-Learning is the flexibility and accessibility of learning and that universities are primarily interested in the strategic implementation of E-Learning to attract as many students as possible and ultimately to generate more incomes.

According to Khan and Iqbal [27], E-Learning strategic plan consists of eight Implementation Parameters:

- Adoption of innovative technologies to facilitate student-centered collaborative learning

environment of education at all level, both outer side and inside of the traditional classroom parameters,

- Formulating curriculum development program for E-Learning, and strengthen digital technologies and web-enhanced learning practices which aligned with the institution vision and goals,
- Providing user-friendly environment and training of tutor/student to fully take advantage of E-Learning modules,
- Providing support and opportunities of professional development to faculty for exploring new E-Learning technologies and methodologies,
- Providing comprehensive packages of technology-banded student services which support the successful completion of students lifelong learning goals,
- Maintenance and improvement of the technological infrastructure which required to create a reliable E-Learning environment,
- Believe on the partnership, which includes, industries, RSD, sister Institution and open globally to provide comprehensive E-Learning tools for professional development,
- Feedback mechanism for continues improvement of E-Learning practices.

They noted that the E-Learning strategic plan is intended to be a road map for all the colleges/ universities of E-Learning implementation.

## V. CONCLUSION

This paper highlights only some of the strategic planning research for the E-Learning implementation. Representative results were identified in each study, but if we summarize the research results, we can say that almost all results indicated the importance of developing strategic guidelines for the introduction of E-Learning in the development plans of higher education sector.

## REFERENCES

- [1] D. G. Obringer, and B.L. Hawkins, "The myth about E-Learning," *Educause review*, 40(4), pp. 14-15, 2005.
- [2] C. Curran, "Strategies for E-Learning in universities," Berkeley, CA: CSHE Research & Occasional Paper Series, 2004.
- [3] T. Bates, "Strategy and visions of E-Learning in higher education," Zagreb, 2005.
- [4] D. Glušac, „Elektronsko učenje," Zrenjanin: Tehnički fakultet Univerziteta u Novom Sadu, 2012. [In Serbian].
- [5] Denic, N., Zlatkovic, D. "A study of the potentials of the distance learning system," *Proceedings - International Conference on Science and Education (IconSE)*, 8, pp. 30-39, 2017.
- [6] Standards and guidelines for quality assurance in the European higher education area (ESG). Brussels, Belgium. 2015. ISBN: 978-9-08-168672-3.
- [7] D. Zlatković, N. Denić, M. Petrović, M. Ilić, "Kvalitativna analiza efekata elektronskog učenja na unutrašnju motivaciju studenata," *Zbornik radova – Nacionalna konferencija sa međunarodnim učešćem – Informacione tehnologije, obrazovanje i preduzetništvo (ITOP)*, str.185-193, 2019. (In Serbian), ISBN 978-86-7776-233-9.
- [8] D. Zlatkovic, N. Denic, M. Petrovic, M. Ilic, "Security and standardization at E-Learning platforms," *Proceedings - 54<sup>th</sup> International Scient. Conference on Information, Communication and Energy Systems and Technologies (ICEST)*, 2019, in press.
- [9] P. Boezeroy, "E-Learning strategies of higher education institutions," Netherlands: CHEPS/UT, 2006. ISBN 90-365-2376-1
- [10] T. Bates, "Upravljanje tehnološkim promjenama, strategije za voditelje visokih učilišta," Zagreb: CARnet, 2004. (In Croatian).
- [11] B.A. Collis, and M.C. Wende, "Models of technology and change in higher education, An international comparative survey on the current and future use of ICT in higher education," Enschede: University of Twente, 2002.
- [12] M. Parker, "Technology-enhanced E-Learning: perceptions of first year information systems students at the Cape Technikon," *Proceedings – The Conference of the South African Institute of Computer Scientists and Information Technologists (SAICSIT)*, pp.316-319, 2003.
- [13] D. Morrison, "E-Learning strategies, how to get implementation and delivery right first time," Hoboken, NJ: Wiley, 2003.
- [14] W. Horton, "DesigningWeb – Based Training," Hoboken, NJ: Wiley, 2000.
- [15] M. J. Rosenberg, "E-Learning, strategies for delivering knowledge in the digital age," New York: McGraw-Hill, 2001.
- [16] R. Hirschheim, "The Internet-based education Bandwagon: look before you leap," *Communications of the ACM*, 48(7), pp. 97-101, 2005.
- [17] H. Maurer, "Necessary aspects of quality in E-Learning Systems," in: "Quality education at a distance" (Eds: G. Davies, E. Stacey), Norwell, MA: Kluwer Academic Publishers, pp. 29-37, 2003.
- [18] S. Young, and M. McSpornan, "Facilitating successful online computing courses while minimizing extra tutor workload," *Proceedings – The 6<sup>th</sup> Australasian Computing Education Conference (ACE2004)*, New Zeland, Dunedin, 30, pp. 349-356, 2004.
- [19] S. L. Howell, P.B. Williams, and N.K. Lindsay, "Thirty-two trends affecting distance education: An informed foundation for strategic planning," *Online Journal of Distance Learning Administration*, 6(3), 2003.
- [20] D. Oreski, "Strategy development by using SWOT – AHP," *TEM Journal*, 1(4), pp. 283-291, 2012. ISSN: 2217-8333.
- [21] V. Nikolic, D. Petkovic, N. Denic, and M. Milovancevic, "Appraisal and review of e-learning and ICT systems in the teaching process," *Physica A: Statistical Mechanics and its Applications*, 513, pp. 456-464, 2019. doi: 10.1016/j.physa.2018.09.003.
- [22] S. Wills, and P. Yetton, "Strategy and Information Technology - Managing the introduction of technology in the delivery and administration of higher education," Canberra: DEST, 1997.
- [23] T. Bates, "Managing technological change. Strategies for college and university leaders," San Francisco, CA, 2000.
- [24] T. Bates, "National strategies for E-Learning in post-secondary education and training,," Paris: UNESCO, 2001.
- [25] S.L. Howell, P.B. Williams, and N.K. Lindsay, "Thirty-two trends affecting distance education: An informed foundation for strategic planning," *Online Journal of Distance Learning Administration*, 6(3), 2003.
- [26] J. Aczel, P. Hardy, O. Cotinat, and H. Igglden, (Eds.), "Identifying innovation in higher education E-Learning strategies," 4<sup>th</sup> EDEN (European Distance and E-Learning Network) Research Workshop, Research into Online Distance Education and E-Learning: Making the difference, Barcelona, Spain, 2006.
- [27] K. U. Khan and J. Iqbal, "Strategic planning of E-Learning implementation in higher education sector," *Proceedings – International Association for Management of Technology (IAMOT)*, pp. 1185-1191, 2015.

# Visualization Tools For Large Amount of Data

N. Ranković<sup>1</sup>, T. Radmanović<sup>2</sup>, D. Ranković<sup>3</sup> and M. Bjelica<sup>2</sup>

<sup>1</sup> Faculty of Sciences, University of Novi Sad, Serbia

<sup>2</sup> Technical Faculty "Mihajlo Pupin", Zrenjanin, Serbia

<sup>3</sup> Medical School "Dr Miša Pantić", Valjevo, Serbia

nrankovic.de@gmail.com, t.radmanovic@yahoo.com, nr17031994@gmail.com, bjelica@tfzr.uns.ac.rs

**Abstract:** Large databases are becoming larger every day, slowing down the process of analyzing them and making the right business decisions. Today's successful business involves collecting, monitoring, analyzing and visualizing large amounts of data. Modern business intelligence is focused on data visualization so that the user can find out the essence of the information collected and analyzed as quickly as possible. This has become almost impossible in modern business without the proper tools for vitalization, which are on the market every day. This paper analyzes and presents the capabilities of some of the most commonly used visualization tools. Each has advantages and disadvantages, and this analysis can help prospective customers choose some of the visualization tools offered, which can meet the specifics of their company's business.

**Keywords:** data visualization, visualization tools, large amount of data

## I. INTRODUCTION

In the modern world, information is the most important resource. The right and a timely business decisions are directly related to the quality of the information available [1]. Data exploration and analysis is a necessary activity, which must be realized when predicting and making decisions based on information about the data analyzed. Based on existing data, it is possible to predict and make decisions in the future business, or in some other forecast [2]. It is thought that large bases will become even larger day by day. Large databases contribute to a better understanding of business performance and processes, but require detailed analysis and preprocessing of data. Due to such problems, modern business intelligence is focused on data visualization, so that the user can find out the essence of a large amount of data as quickly as possible. Today, there are a number of data mining and data visualization tools emerging on the market. In this paper, we will analyze tools for displaying and/or visualizing data [3].

### A. Historical view of data visualization

The term visualization occurs as early as 2,500 years ago when there were not even computers or tools for analysis with visual solutions. As in all previous periods, different ways of presenting data were used to make important decisions. Data visualization provides the best overview of a large number of collected and analyzed data [4]. Simple graphs of given data can replace hours and days of searching large amounts of data while being easy to read, interpret and find the results you want [5].

The beginning of data visualization dates back to the 17th century, showing a diagram of statistics by Michael

van Langren. This visualization time has become popular because it has made it easier for many to navigate historical reviews.

Over time, the different types and forms of data presentation changed, the various graphical representations improved and became more transparent and clearer as colors were added [3,6].

In the 19th century, 3D graphical visualization of data was already occurring for the first time in Sweden, showing the increasing population of this country [7].

Nowadays, presenting a large amount of data is almost unthinkable without certain tools, which can quickly and easily find the required data, presenting it in various visual ways.

## II. DATA VISUALIZATION

Data visualization means presenting data in various ways from the simplest spreadsheet to complex three-dimensional graphical representations. Large amounts of data can be presented in tables, charts, but large amounts of data remain opaque. The development of computer technologies makes it possible to collect large amounts of data faster [3]. A large amount of data collected requires adequate analysis and proper presentation in order to be useful to the organizations who have the data.

Various ways of presenting data have been used in ancient times. The most common and long-used ways of presenting data are in tables and charts, but significant advances in technology have also enabled the advancement of data visualization, which has evolved into what is now considered visualization [8].

The basic task of data visualization is to create a visual presentation of a large amount of data that will be easy and understandable for every user. Data visualization enables users to present various processes and phenomena and their results in a visual form and in an understandable way so that the presented data, discrepancies, and relationships between them can be understood [4].

Data visualization in modern business is an integral part of all modern business intelligence tools. The world's leading business intelligence leaders, Microsoft Power BI, Tableau and Qlik, rely on data visualization tools. The users of these tools, with high quality and simple visualization, enable easy and quick understanding of the information that results from a series of complex analyses of large quantities of new and stored data [4,9].

Data visualization is the best way to convey large amounts of information in small spaces. Visualization enables a quick and effective interpretation of the results obtained.

Data visualization, in addition to its extremely large application in business intelligence systems of companies, is also widely used in Big data analysis and Advanced analytics [5].

The aim of visualization is to determine and present appropriate interconnected structures and relationships in both scientific (computational and medical sciences) as well as in more abstract datasets [3,10].

The main objective of the presentation should be to convey information from the dataset in a way that enhances understanding.

Although current visualization techniques exploit only the visual abilities of humans, other sensory modalities are explored. These include sound and touch, which can help in the process of information discovery.

### III. DATA VISUALIZATION TOOLS

Modern business in the world and in our country today is based on collecting and analyzing a large amount of information and data needed on a daily basis. The amount of information required to monitor and run a successful business depends on the rapid collection, sorting of information and data and making timely decisions in accordance with the data analyzed. In order to select, select and analyze only the data you need, a tool is needed that can be done in the fastest and most efficient way [1].

There are different groups of tools, tools for searching or mining data, tools for analyzing data sets, tools for statistical data processing [5,11]. In addition to a large number of this group of tools, there are numerous tools for displaying or visualizing the data obtained. There are also tools that perform a search, selection, and display of the requested data [1,12].

Choosing a visualization tool must meet the requirements and needs of the company that uses them. The selected tool must enable the necessary data to be tracked, presented in a simple visual way, using appropriate graphically advanced views, which will be best understood by analysts and company managers [13].

There are a number of data visualization tools in the world and here. They are all designed to provide the fastest and simplest possible visual representation of the required data, in a way that will be understandable to all users. Large companies, depending on how they are doing business or service providers, have different needs and desires to have equal resources and useful data. They will look for tools that will allow them to manage their entire business, optimize a

large number of processes, use and use the vast amount of data collected, and better control over the organization. Also, unlike them, smaller organizations are looking for solutions that will allow them to survive in the market [14].

Among the many tools on the market will be those tools for which various surveys and users themselves have shown to be most commonly implemented in companies, and have proven to be extremely useful and effective. Data exploration and analysis is an inevitable part of the activity that is needed to predict and make informed decisions. You cannot access predictions unless you know what happened in the past [1,15].

Currently, among the best data visualization tools in the world are:

**1. Microsoft Power BI:** (<https://powerbi.microsoft.com/en-us/>)

Microsoft Power BI is a powerful tool for visualizing large amounts of data. Power BI is a comprehensive analytics and visualization tool that provides access to data for all users who need it.

**2. Tableau Public:**

(<https://public.tableau.com/s/>)

Tableau Public is a data visualization tool. An extremely fast and superior tool, simultaneously for visualizing, exploring and analyzing data through various types of graphical representations. (7)

**3. QlikView:**

(<https://www.qlik.com/us/>)

Qlikview is one of the most popular business intelligence tools in the world. In addition to its exceptional data visualization capabilities, it has great data management capabilities and is great for data exploration and trends.

**4. Rattle GUI:**

(<https://cran.r-project.org/bin/windows/base/>)

Rattle GUI R-based tool. In order to use it, R. must be installed. It has a very large application and is used for statistical analysis of data, which can be represented graphically and visually well.

**5. Orange:**

(<https://orange.biolab.si/>)

The Orange tool is created to provide an interactive visualization of data related to data search. It has its own large library for data mining tasks.

**6. Open Refine:**

(<http://openrefine.org/download.html>)

Open Refine is a tool designed for unedited data, deletion, transformation and formatting for predictive models. 80% of the time is spent sorting the data. In addition to saving time,

analysts who use Open Refine will be able to use it productively.

**7. Talend:**

(<https://www.talend.com/resources/data-trust-readiness/>)  
This tool helps in decision making based on the analysis of a large amount of data. It is a tool used to clean, transform and visualize data. The Talend tool has a feature that automates data that can be stored and later modified on a new data set, which does not exist in most other tools.

**8. Data wrapper:**

(<https://www.datawrapper.de/>)  
Data wrapper is extremely fast data visualization software and does not require any software installation.

In addition to these tools, there are many significant tools that can collect, analyze and display data in an extremely good way.

**IV. ANALYSIS OF SELECTED TOOLS**

For comparative analysis of the efficiency and transparency of the results obtained, a database of a business organization of an arbitrary "Bank" of data was selected. Almost all tools have the ability to import data. Thus, the same database "Bank" is presented and analyzed in four different tools.

Analyzed tools:

**1. Tableau Public:** (<https://public.tableau.com/s/>)

The database was formed in .xlsx format and contained the following parameters: client's name and surname, gender, address, place, country of residence, telephone, e-mail, account number, card type, number of loans raised, debit and client savings. After importing the data from the formed Bank database into the selected Tableau tool, it was possible to analyze and visually display various reports. Most often reports were generated on the bank's customers, their loans, debts, cards and other data.

**Figure 1.** gives a visual representation of the highest city debt by gender and number of loans clients have.

**Figure 2.** gives a visual representation of the highest national debt by gender and number of loans clients have.

**Figure 3.** gives a visual representation of the following parameters: savings and bank customers' debts by city, card type, and gender.

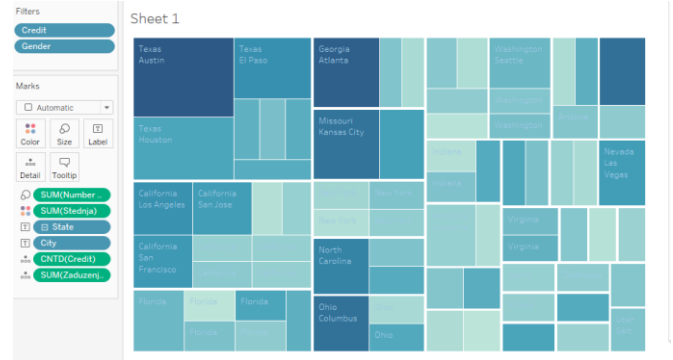

**Figure 1.** Highest city debt by gender and number of credits

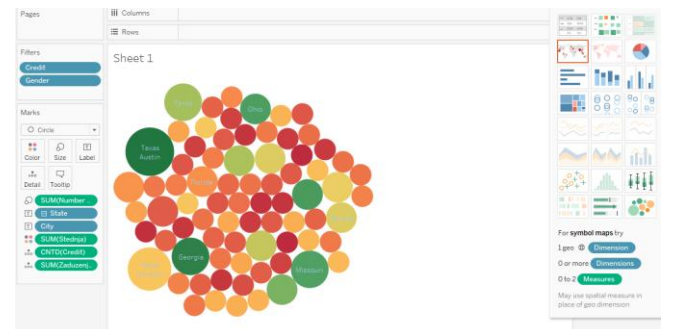

**Figure 2.** Highest national debt by gender and number of loans clients have

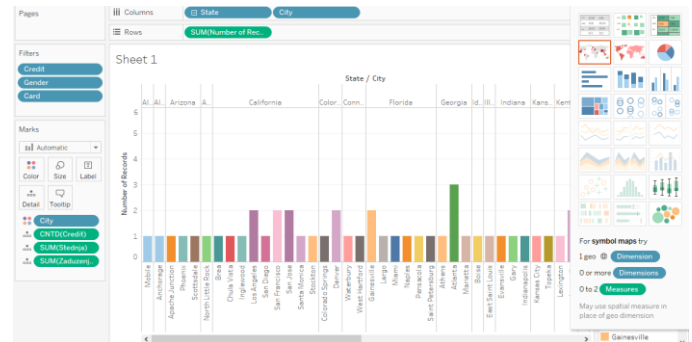

**Figure 3.** A visual representation of the savings and debt of the bank's customers by city, card type and gender.

**2. QlikView:** (<https://www.qlik.com/us/>)

After importing data from the formed „Bank“ database, in .xlsx format, into the selected QlikView tool, it was possible to analyze and visually display various reports.

**Figure 4.** gives a visual representation of average savings and customer debt by city, shown on the map.

Average savings of bank clients by city and gender is displayed. **Figure 5.**

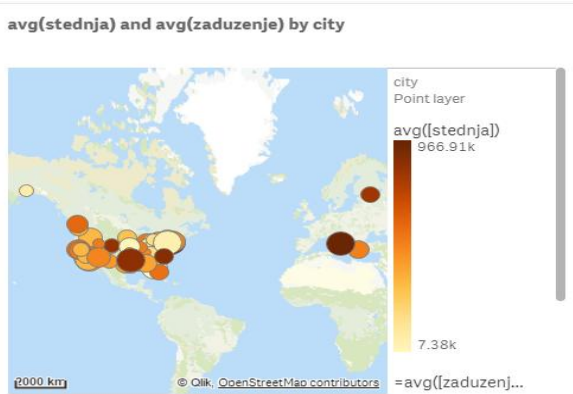

**Figure 4.** Average savings and customer debt by city represented on the map

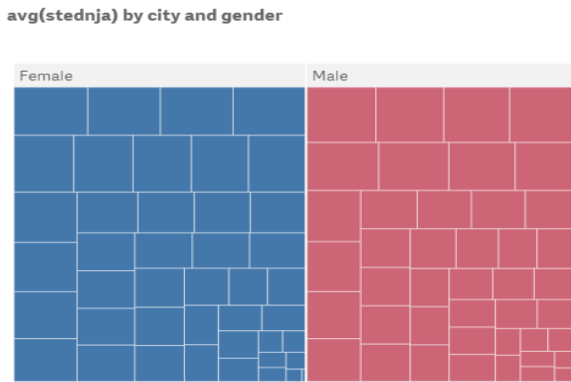

**Figure 5.** Average savings of bank clients by city and gender is shown

**3. R Studio:** (<https://www.rstudio.com/>)  
After importing data from the formed „Bank“ database, in .xlsx format, into the selected R Studio tool, it was possible to analyze and visually display various reports

When searching the „Bank“ database, the largest transactions that bank clients performed by country are displayed (savings, debit, credit, etc). **Figure 6.**

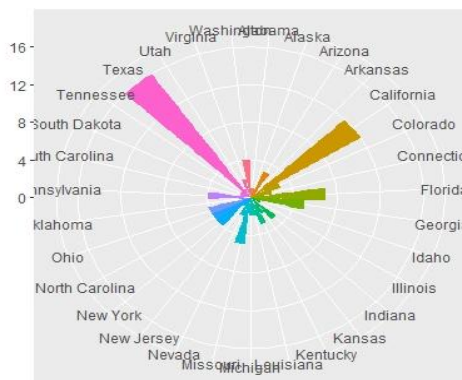

**Figure 6.** The largest transactions that bank clients performed by country

When searching the „Bank“ database, the credit cards most commonly used by customers for savings are displayed. **Figure 7.**

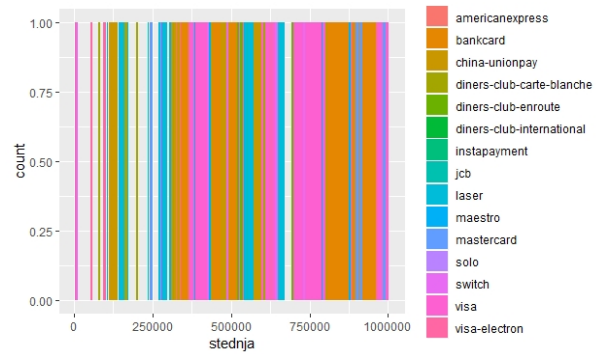

**Figure 7.** Credit cards most commonly used by customers for savings

**4. Datawrapper:** (<https://www.datawrapper.de/>)  
After importing data from the formed Bank database, in the format .xlsx, into the selected Datawrapper tool, it was possible to analyze and visually display various reports.

When searching the „Bank“ database according to card types and state, savings and debit are shown. **Figure 8.**

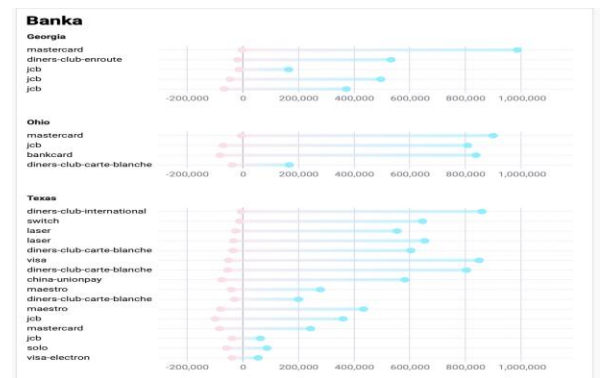

**Figure 8.** Savings and debit by card type and state are shown

When searching the „Bank“ database according to gender and account number, debit and savings are displayed. **Figure 9.**

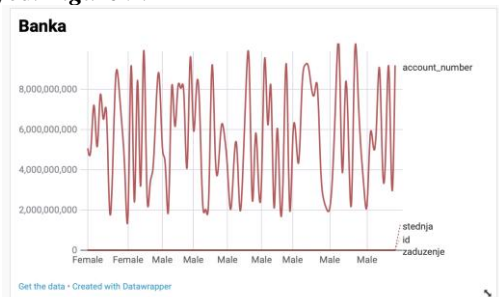

**Figure 9.** Savings and debts by account number and gender are shown

When searching the „Bank“ database according to several selected card types, card ID, account number, debit and savings are displayed. **Figure 10.**



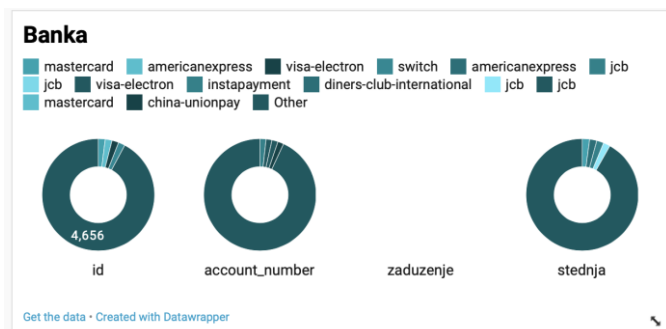

Figure 10. Card id, account number, debit and savings by several card types are shown

## V. DISCUSSION

Of the many data visualization tools, it is quite difficult to choose a tool that will meet all the business needs of the company. Each tool has its own idea and the way it wants to portray its vision of the analyzed data and the visualization of the data [15]. As with other software products, it is sometimes impossible to find a solution that meets all business and technical needs. The deciding factors for choosing the right tool could be classified into four groups:

### 5.1. Reporting Data Visualization Tools

Business Reporting visualization tools enable companies to monitor and monitor their important business processes and make faster and more accurate decisions based on them. The most commonly used tools for business purposes are Tableau Software, Microsoft Power BI and Qlik Sense [1,16].

### 5.2. Costs of data visualization tools

Tools cost, the biggest expense is the cost of the licenses that are most commonly purchased as a capital investment. In addition to purchasing licenses, there is the cost of training employees. Users need to be advised on how to use the tools and what are their essential functionalities [1,5].

### 5.3. Different data sources for visualization

In the digital age, the number of data sources is increasing, in addition to classic data sources such as relational databases, there are a number of semi-structured and unstructured data sources that need to be formatted for data analysis and visualization. Certainly the most famous of these is Microsoft Power BI [3,17].

Each of the analyzed tools has its advantages and disadvantages and their selection and use depend on many factors, conditions. Considered by the users these are Tableau Software, if we look at the price then it's Power BI.

TABLE 1. Comparative analysis of selected analyzed visualization tools

Tool	Tableau	QlikView	R Studio	Datawrapper
Free trial	Yes	No	Yes	Yes
Supports API	No	Yes	Yes	Yes
Choice of visualization	High	High	Medium	Medium
Price	42\$	125\$	21\$	21\$
Size of the organization	Small Medium Big	Small Medium	Medium Big	Small Medium
Operating system	Mac Windows Linux iOS Android	Windows iOS Android	Mac Windows iOS Android	Web application

## VI. CONCLUSION

Introducing and using data visualization software tools shortens the time to find the right data that will allow you to make the right decisions about how to proceed with your business success. For all companies nowadays, the use of visualization tools is almost a standard for a successful business. Tools cost, but ultimately yield results that are more important than the cost of purchasing them [1,3].

The use of visualization tools can provide: better decision making, increased business efficiency, better forecasting, and optimization of available resources, strengthening confidence in the organizational system.

The tools presented in this paper offer different data visualization options. Depending on the size, needs, and cost, organizations are choosing the tools that will best help guide the flow of business to a successful direction [1,2].

## REFERENCES

- [1] Bizaca R., Comparison of Data Visualization Tools, Faculty of Economics, Split, 2017.
- [2] Pivac A., Data visualization tools and their application in Croatia, Faculty of Economics, Split, 2017.
- [3] Ivezić B. „BI i CRM projects strong Adact“, Business diary, 2016. <http://www.poslovnih.hr/tehnologija/bii-crm-projekti-ojacali-adact-310214>
- [4] "Business Analytics vs Business Intelligence?". timoelliott.com. 2011-03-09. Retrieved 2014-06-15.
- [5] Blagović, L. „Data visualization in the business intelligence system“, University Jurja Dobrile in Pula, Pula, 2016., <https://dr.nsk.hr/islandora/object/unipu%3A794/datastream/PDF/view>
- [6] Brath, R., Peters, M. , Dashboard design: Why design is important. Data Mining Review/Data Mining Direct, 2004.
- [7] Friendly, Michael, "A Brief History of Data Visualization" (PDF). York University. Springer-Verlag. Retrieved 2015-11-22, 2006.
- [8] Rouse, M. „Data visualization“ <http://searchbusinessanalytics.techtarget.com/definition/data-visualization>
- [9] Kerschberg, B. „Five Key Properties of Interactive Data

Visualization“ ,

<https://www.forbes.com/sites/benkerschberg/2014/04/30/five-key-properties-of-interactive-datavisualization/#118bef98589e>

- [10] D.Milošević, available at: <https://dusanmilosevic.com/vizualizacija-podataka-kroz-istoriju-sa-11-primeru/>
- [11] Sataric B., New Concepts in Digital Literacy: Data Visualization and Applications, DMS Serbia, Belgrade, 2019.
- [12] Friedman, "Data Visualization and Infographics" in: Graphics, Monday Inspiration, 2008.
- [13] Vitt, E., Luckevich, M., Misner, S.: Business Intelligence, Microsoft Press, Redmond, 2002.
- [14] Julian, Taylor., "Business intelligence implementation according to customer's needs" , 2010.
- [15] Vera, D. (2013.): How to Future-Proof Your Dashboards, TDWI, <https://tdwi.org/Articles/2013/06/04/Future-Proof-Dashboards.aspx>, 2016.
- [16] Watson, H.J., Wixom, B.H., Buonamici, J.D., Revak, J.R.: Sherwin-Williams Datamart Strategy: Creating Intelligence Across the Supply Chain, Communications of the Association for Information Systems, 2001., 5 (9), 2001.
- [17] Few, S., Information dashboard design, O'Reilly, SAD, 2006.

# Security of the Most Frequently Used Web Content Management Systems

V. Kraguljac\*, D. Milošević\*\* and T. Dlabac\*\*\*

\* University of Kragujevac, Faculty of Hotel Management and Tourism, Vrnjačka Banja, Serbia

\*\* University of Kragujevac, Faculty of Technical Sciences, Čačak, Serbia

\*\*\* University of Montenegro, Faculty of Maritime Studies, Kotor, Montenegro

vladimir.kraguljac@kg.ac.rs, danijela.milosevic@ftn.kg.ac.rs, tanjav@ucg.ac.me

**Abstract - The topic of this paper is to test the security of two of the most popular web content management systems, WordPress and Joomla, with the default setup method and how they are most commonly used. Two test sites were implemented and a penetration test was performed. The results of this testing show that there are numerous problems. Finally, possible steps for raising security to a higher level are suggested.**

## I. INTRODUCTION

The expansion of Internet usage is more prominent than ever. August 2019 data shows that the number of websites has exceeded 1.2 billion, nearly 240 million of which are active. The number of computers connected to the Internet is nearly nine billion [1]. According to the end of June 2019 data, the number of Internet users is nearly four and a half billion, with penetration rates higher than 57% [2].

Web content management systems (WCMS) have a large and ever-growing role in the aforementioned expansion of the Internet. Currently, 56% of all Internet sites use some of these systems. The two most used of them are WordPress and Joomla. WordPress runs 34.5% of all sites on the Internet, and 61.1% of sites made using a web content management system. Joomla, although ranked second, has a significantly lower share - 2.8% of all sites, and 5% of those with a web-based content management system [3].

WCMS makes it easy to create, organize and maintain web content. One of the most important features of WCMS is the modularity that allows users to implement the various additional features they need to build a website to their liking.

This is one of the reasons for the emergence of Web 2.0 and the expansion of user-generated content on the Internet, because today even users without special technical knowledge can easily create sophisticated web applications, such as web stores and similar interactive business applications. Simplification of these procedures has had a positive effect on the exchange of knowledge and information and the increase of business activities, but at the same time, the number of security threats has been increasing. This is primarily related to the various malicious activities associated with the vulnerability of commonly used WCMSs.

WordPress is the most popular WCMS in the world for a reason. In addition to the great functionality and ease of use of the basic installation, there are thousands of plugins, controls, and themes that extend the original purpose of blogging to rich multimedia galleries, e-commerce, and more [4].

Joomla is another free open source WCMS that has great expandability. It is based on a model-view-controller framework for web applications that can be used to build online applications independently of CMS. Joomla is not overly demanding, but it still needs some more technical training than WordPress [5].

## II. WEBSITE SECURITY ANALYSIS

There are numerous dangers that can compromise the security of the website, as well as the safety of users who visit it. According to [6], the most common ones identified during 2017 can be classified into the following ten categories:

- A1 - Injection - An application is susceptible to this type of attack when user inputs are not quality checked, filtered or cleaned.

- A2 - Broken Authentication - Attackers have access to hundreds of millions of valid username and password combinations to log in to a variety of online applications. In addition, they have a list of default administrator accounts, as well as numerous tools for using brute force, automatic dictionary-based attacks.

- A3 - Sensitive Data Exposure - This applies to both the transmission and storage of data. The data to pay particular attention to are passwords, credit card numbers, health records, personal information and business secrets - all data requiring additional protection under regulations such as the EU General Data Protection Regulation (GDPR).

- A4 - XML External Entities (XXE) - Web applications, especially XML-based services, are vulnerable to attack if they accept XML directly or by upload. If an application is sensitive to XXE attacks, it probably means that it is also subject to a denial-of-service attack (DoS attack), including a billion laughs attack.

- A5 - Broken Access Control - Access control should ensure that users cannot act outside of their assigned per-

missions. The denial of protection usually results in unauthorized access to, modification of or destruction of the information.

- A6 - Security Misconfiguration - For example, if there is a lack of adequate security in any part, unnecessary features are enabled or installed, active default accounts and/or passwords are left, excessively informative error messages are displayed when there are errors in the code, most recent security features are not enabled or not configured properly, outdated software with known flaws is used...

- A7 - Cross-Site Scripting (XSS) - There are three forms of XSS. The application includes unverified and unprotected user input as part of the HTML output; The application stores inappropriate user input that is later available to other users or the administrator; JavaScript frameworks or applications that dynamically include attacker-controlled data.

- A8 - Insecure Deserialization - Applications are compromised if they deserialize malicious objects inserted by an attacker.

- A9 - Using Components with Known Vulnerabilities - Each organization must ensure that there is a continuous plan to monitor, triage, and apply updates or changes to the configuration of the application for as long as it is being used.

- A10 - Insufficient Logging & Monitoring - Critical events are not logged, alerts and errors do not generate any log files, suspicious activity is monitored, logs are only stored locally, penetration testing does not trigger any alerts, the application cannot detect, record and alert to active attacks in real time or near real time, and the like.

### III. INTERNET SECURITY - RELATED WORKS

With the expansion of the use of the Internet, it is inevitable that the number of security threats that are present is constantly increasing. There is a great number of scientific papers aimed at analyzing this problem and finding possible solutions.

There are different approaches and methods of risk assessment on the Internet. One of the most common is the Information Security Risk Assessment (ISRA) method. In [7], the authors are concerned with the formation of an effective framework that would serve to evaluate the completeness of such methods through their mutual comparison. As a result, the Core Unified Risk Framework (CURF) is proposed as a comprehensive approach to compare different methods. In addition to addressing the assessment tasks that are an integral part of the methods observed and the potential security issues being checked, the strength of this framework is its openness to extensions. When during the assessment of a method a step that is not covered is encountered, it is added to the framework. In addition, during the work on the formation of the aforementioned framework, the authors have identified and analyzed several shortcomings in the observed methods.

In [8], the authors propose the use of Lattice-based deniable ring signatures. This way of generating signatures

maintains anonymity, which is especially important on the Internet. With the development of quantum computing and the new power it brings, one has to think about the resilience of cryptography to quantum algorithm attacks. The authors state that, as far as it is known today, there is no such a successful algorithm for grid-based schemes. An example of how this could be used is to form a group organized into a ring by all the contributors to a particular WCMS. When publishing an add-on, the author would sign it with their public key, and would be anonymous. In case any malicious code is detected, it would be possible to determine, if necessary, whose add-on it is.

Today, there are numerous security risks associated with websites. Many of them reach far beyond the scope of the site itself and the data on it, so they are not easily visible. Thus, in [9], the authors presented the risk of stealing user PINs on Android mobile phones using JavaScript embedded on an infected website. This confirms that raising the security of sites is extremely important as it is intertwined with wider security issues.

Complicating Internet security issues is the increasing need to switch from a traditional user name / password system to an environment where secret keys, both private and public, are generated and distributed to each user. This transition is compounded by the steady increase in the number of devices that individual users use, as well as the expansion of the infrastructure that must be maintained for each individual service to keep the keys updated. Thus, in [10], the authors have developed a framework that provides cryptographic identification of a dynamically growing suite of services while protecting privacy for device groups and their users without the need to establish and maintain expensive infrastructure and complicated management procedures.

Mass attacks on websites are the leading cause of malicious infection on the Internet. The attacked website is infected with a code that seamlessly redirects visitors to a malicious website. That site contains code that attacks the web browser's weak spots. Furthermore, the browser automatically becomes infected by malware by accessing the malicious website. This kind of malware can also steal administrator access data. Most often, this information is passed on to other attackers. In [11], the authors proposed, in order to effectively detect and prevent the spread of such infections, a monitoring system called the HoneyCirculator. This system, using the well-known honeypot principle, actively simulates vulnerability and attracts attackers to a server that acts as a compromised web content management system.

Nowadays, much of the activity related to protecting sites from malicious access in the first step comes down to recognizing whether a site is accessed by a person or a bot. To do this effectively in [12], the authors propose the use of a pictorial intelligent system for human identification (PiSHi). This is one of the extensions and upgrades of the well known CAPTCHA (Completely Automated Public Turing Test to Tell Computer and Humans Apart) system that has been in use since 2000.

Unfortunately, neither WordPress nor Joomla have an option to use any of these systems in their default installation, and this must be solved later using plugins.

All this confirms the view that the issue of site security on the Internet should not be left to end users, as they certainly do not have the necessary capacity to deal with this area. It is possible that the formation of special groups in WCMS development teams to monitor and implement current guidelines in this area would have a positive impact on their overall security.

In [13], the authors analyze the vulnerability of faculty sites in Serbia that were made using WCMS. They look at the server and client side of the site separately and make some recommendations on how the deficiencies identified can be mitigated. Vulnerabilities were identified which were further categorized by the authors. A small number of vulnerabilities were classified as high risk, but a high number of vulnerabilities was identified as low risk.

The authors in [14] analyze the latest major vulnerabilities of WCMS and the effectiveness of responses from different security communities, and make suggestions for improving them. Unfortunately, the results obtained by the authors show that the major parties involved in web security management do not have properly organized responses in the case of newly discovered vulnerabilities.

[15] outlines major security issues related to content management systems. As a possible solution to help combat detected security gaps, a tool has been proposed in the form of a concept that allows any user to report any identified problem, all with the aim of reducing the vulnerability of any content management system.

#### IV. METHODS

For the purpose of this work, two sites were created on a launched web server using WordPress and Joomla web content management systems. To somewhat simulate the frequent real-life situation, newer versions of WCMS were used, but not the latest - for WordPress 4.9.8 and Joomla 3.8.12. The sites were run with the default content that could be obtained during installation. No add-ons and extensions were installed.

Penetration testing (pentest) is a method of assessing site security by simulating attacks by malicious users who are not authorized to access the site administration and malicious insiders who have some degree of authority for that access. An active analysis of the system is performed to find out any errors that are most often caused by the incorrect configuration of the system, known and unknown hardware or software defects.

As the first site security checker, OWASP foundation open source security tool called Zed Attack Proxy (ZAP) in version 2.7.0 was used [16].

The second tool was Burp Suite, a free trial of Professional Edition in version 1.7.36. [17].

#### V. RESULTS

The Joomla and WordPress sites penetration test was first performed using the OWASP ZAP package in standard mode. Subsequently, testing was repeated in active attack mode. The groups and number of individual security risks detected during the penetration test are shown in the Table I.

TABLE I. OWASP ZAP TEST RESULTS

Omission category	Joomla		WordPress	
	Standard mode	Attack mode	Standard mode	Attack mode
High risk				
Cross Site Scripting (Reflected)	217	114	/	/
SQL Injection	15	1	/	/
Medium risk				
Application Error Disclosure	229	205	702	702
Buffer Overflow	74	44	/	/
Directory Browsing	25	25	97	97
Format String Error	8	8	/	/
X-Frame-Options Header Not Set	399	259	903	902
Low risk				
Content-Type Header Missing	46	46	/	/
Cookie No HttpOnly Flag	1	/	13	13
Incomplete or No Cache-Control And Pragma HTTP Header Set	1	1	/	/
Private IP Disclosure	6	/	/	/
Web Browser XSS Protection Not Enabled	407	259	909	908
X-Content-Type-Options Header Missing	1121	808	1332	1331

Further, the Joomla and WordPress sites penetration test was performed using the Burp Suite PE package in the passive scan mode. After that, the test was repeated in active mode. The groups and number of individual security risks detected during the penetration test are shown in the Table II.

TABLE II. BURP SUITE PE TEST RESULTS

Omission category	Joomla		WordPress	
	Passive scanning	Active scanning	Passive scanning	Active scanning
High risk				
Cross-origin resource sharing: arbitrary origin trusted	/	/	/	3
Clear text submission of password	18	19	1	1
SQL Injection	/	1	/	1
Low risk				
Password field with autocomplete enabled	19	20	/	1
Client-side HTTP parameter pollution (reflected)	/	18	/	2
Form action hijacking (reflected)	/	2	/	/
Content type incorrectly stated	/	3	/	9
Open redirection (DOM-based)	/	3	/	/
Source code disclosure	/	/	/	1
Link manipulation (DOM based)	/	/	/	6

Omission category	Joomla		WordPress	
	Passive scanning	Active scanning	Passive scanning	Active scanning
Alert information				
Content type incorrectly stated	3	/	/	/
Duplicate cookies set	1	1	/	/
Input returned in response (reflected)	/	326	/	1188
Cross-domain referer leakage	11	11	3	3
Email addresses disclosed	2	2	5	5
HTML does not specify charset	3	3	/	/
Content type is not specified	8	8	/	/
Referer-dependent response	/	2	/	191
Suspicious input transformation (reflected)	/	38	/	7
Frameable response (potential Clickjacking)	41	42	105	105
Link manipulation (reflected)	/	1	/	/
Directory listing	25	25	97	97
Base64-encoded data in parameter	3	4	/	/
File path manipulation	/	1	/	/
Cross-site request forgery	/	8	/	2
Cross-origin resource sharing	/	/	/	3
Cookie without HttpOnly flag set	/	/	1	1
Multiple content types specified	/	/	5	5
Spoofable client IP address	/	/	/	191
User agent-dependent response	/	/	/	191
DOM data manipulation (DOM-based)	/	/	/	1

## VI. DISCUSSION

A summary of identified security risks grouped by severity is given in Table III.

Looking at the figures obtained, it is worrisome to conclude that the two most popular WCMSs in their basic configuration have a significant number of serious security vulnerabilities. Joomla has a number of high-risk failures, totaling 385. WordPress is in a noticeably better position with six revealed. Looking at the medium and lower risk glitches, it can be concluded that WordPress loses the aforementioned advantage. Based on what was observed, it cannot be said which WCMS is safer. It is only fair to conclude that both WCMSs, in the basic configuration provided by the installation, are unsafe.

## VII. CONCLUSION

This paper analyzes the security of web content management systems. The two most popular were observed - WordPress and Joomla. In a controlled environment, penetration testing of two test sites was done.

Although these sites were run only with the default content that can be obtained during installation, the test results showed a worryingly high number of detected security vulnerabilities. The situation is all the worse as no

TABLE III. SUMMARY TEST RESULTS OF JOOMLA AND WORDPRESS SITES

Omission category	Joomla		WordPress	
	OWASP ZAP	Burp Suite PE	OWASP ZAP	Burp Suite PE
High risk	347	38	/	6
Medium risk	1276	/	3403	/
Low risk	2696	65	4506	29
Alert information	/	569	/	2206
<b>In total</b>	<b>4319</b>	<b>672</b>	<b>7909</b>	<b>2241</b>
	<b>4919</b>		<b>10150</b>	

add-ons and extensions have been installed. The WCMSs have been developed by teams of professionals with the active cooperation of numerous volunteers around the world and with the existence of special teams dedicated solely to security. Their add-ons and extensions are often developed by small informal groups and even individuals, thus code control, detecting omissions and correcting them in a timely manner is lacking by far. Adding to the above, these are open source systems, which means that malicious people can easily see the code itself, which is a very alarming situation. In addition, most of these sites are hosted on shared servers, so compromising the security of one of these sites often entails disabling all its neighbours.

In this situation, what would be good advice for the steps that should be taken to raise security to a higher level? Maybe changing the most common way these systems are used should be taken into consideration? This would mean abandoning such a laudable practice where end-users create and maintain sites themselves and leave that part to the professionals. The professionals are better acquainted with the technologies used, and are regularly monitoring various sources of information on perceived deficiencies in WCMSs and their additions and extensions. They are certainly better equipped to apply the recommended procedures to fix these deficiencies and mitigate the consequences that might have occurred. End users, with the necessary training, could retain the responsibility of updating the sites' content. In addition to changing the basic system of how WCMSs are used, it would be good to establish a more tightly controlled way of downloading and controlling their add-ons and extensions. This primarily refers to more serious scrutiny of the code before it is made available for download, but also to the establishment of an effective way of alerting for deficiencies. This could be done by registering the user's email address when downloading add-ons and extensions, and then circulating a notification to anyone who has downloaded the add-on or extension, if a problem is detected.

## REFERENCES

- [1] Netcraft Ltd. (2019, 08 15). *August 2019 Web Server Survey*. Retrieved 08 21, 2019 from Netcraft | Internet Research, Anti-Phishing and PCI Security Services: <https://news.netcraft.com/archives/2019/08/15/august-2019-web-server-survey.html>
- [2] Miniwatts Marketing Group. (2019). *World Internet Users Statistics and 2019 World Population Stats*. Retrieved 08 21, 2019 from Internet World Stats - Usage and Population Statistics: <https://www.internetworldstats.com/stats.htm>
- [3] Q-Success Web-based Services. (2019). *Usage of content management systems*. Retrieved 08 21, 2019 from W3Techs - World Wide Web Technology Surveys: <https://w3techs.com/technologies/overview/contentmanagement/all>

**International conference on Applied Internet and Information Technologies  
October 3-4, 2019, Zrenjanin, Republic of Serbia**

---

- [4] *Blog Tool, Publishing Platform, and CMS - WordPress*. (2018). Retrieved 09 15, 2018 from WordPress.org: <https://wordpress.org/>
- [5] Open Source Matters Inc. (2018). *Joomla Content Management System (CMS) - try it for free!*, Retrieved 09 15, 2018 from Joomla!: <https://www.joomla.org/>
- [6] The OWASP Foundation. (2018). *Category: OWASP Top Ten Project - OWASP*. Retrieved 09 15, 2018 from The OWASP Foundation: [https://www.owasp.org/index.php/Category:OWASP\\_Top\\_Ten\\_Project](https://www.owasp.org/index.php/Category:OWASP_Top_Ten_Project)
- [7] Wangen, G., Hallstensen, C., & Snekkenes, E. (2018, 11). A framework for estimating information security risk assessment method completeness. *International Journal of Information Security*, 17(6), pp. 681–699.
- [8] Gao, W., Chen, L., Hu, Y., Newton, C. J., Wang, B., & Chen, J. (2018, 08). Lattice-based deniable ring signatures. *International Journal of Information Security*, pp. 1-16.
- [9] Mehrnezhad, M., Toreini, E., Shahandashti, S. F., & Hao, F. (2018, 06). Stealing PINs via mobile sensors: actual risk versus user perception. *International Journal of Information Security*, 17(3), pp. 291-313.
- [10] Kluczniak, K., Wang, J., Chen, X., & Kutylowski, M. (2018, 04). Multi-device anonymous authentication. pp. 1-17.
- [11] Akiyama, M., Yagi, T., Hariu, T., & Kadobayashi, Y. (2018, 04). HoneyCirculator: distributing credential honeytoken for introspection of web-based attack cycle. *International Journal of Information Security*, 17(2), pp. 135-151.
- [12] Mehrnezhad, M., Ghaemi Bafghi, A., Harati, A., & Toreini, E. (2017, 04). PiSHi: click the images and I tell if you are a human. *International Journal of Information Security*, 16(2), pp. 133-149.
- [13] Milic, P., Kuk, K., Mišić, J., & Kartunov, S. (2017). Security assessment of university websites in Serbia by using automated black. V B. Simeunović-Patić (Yp.), *International scientific conference "Archibald Reiss days" thematic conference proceedings of international significance* (pp. 223-232). Belgrade: Academy of criminalistic and police studies.
- [14] Jerkovic, H., & Sinkovic, B. (2017). Vulnerability analysis of most popular open source Content Management Systems with focus on WordPress and proposed integration of artificial intelligence cyber security features. *International Journal of Economics and Management Systems*, 2, pp. 66-74.
- [15] Conțu, C. A., Popovici, E. C., Fratu, O., & Berceanu, M. (2016). *Security issues in most popular content management systems*. Retrieved 09 15, 2018 from ResearchGate: <https://www.researchgate.net/publication/310627100>
- [16] The OWASP Foundation. (2018, 06 14). *OWASP Zed Attack Proxy Project - OWASP*. Retrieved 09 15, 2018 from The OWASP Foundation: [https://www.owasp.org/index.php/OWASP\\_Zed\\_Attack\\_Proxy\\_Project](https://www.owasp.org/index.php/OWASP_Zed_Attack_Proxy_Project)
- [17] PortSwigger Ltd. (2018). *Web Application Security, Testing, & Scanning | PortSwigger*. Retrieved 09 15, 2018 from PortSwigger: <https://portswigger.net/>

# Knowledge and Importance of Different IT fields for Professional Engagement

M. Blagojević\*, N. Stanković\* and M. Papić\*

\* University of Kragujevac, Faculty of Technical Sciences, Čačak, Serbia  
marija.blagojevic@ftn.kg.ac.rs, nebojsa.stankovic@ftn.kg.ac.rs, milos.papic@ftn.kg.ac.rs

**Abstract - The paper presents analysis which is related to subjective opinion of teachers regarding necessary knowledge and importance of different IT fields for professional engagement. In the research ANOVA method is used. Teachers of informatics subjects in high schools take participation in research. The results show that there is significant difference between fields within Information technology. Teachers differently evaluate the importance and knowledge of the IT area for their professional engagement**

## I. INTRODUCTION

The Information technology play very important role in almost every aspect of life. With the significant of Information technology the quality of education process in the field is becoming more important. According to ISO/IEC standardization [1] the Information technology (ICS=35) is classified

- 35.020 Information technology (IT) in general
- 35.030 IT Security
- 35.060 Languages used in information technology
- 35.080 Software
- 35.100 Open systems interconnection (OSI)
- 35.110 Networking
- 35.140 Computer graphics
- 35.160 Microprocessor systems
- 35.180 IT terminal and other peripheral equipment  
Including modems
- 35.200 Interface and interconnection equipment
- 35.220 Data storage devices
- 35.240 Applications of information technology

Serbia has performed the reform of primary and secondary education. The reform has been implemented separately from the reform of higher education. The reform of primary and secondary education is carried out more centrally, while higher education reform is implemented by the higher education institutions themselves. The Government of the Republic of Serbia adopted in 2012 the Strategy for the Development of Education in Serbia until 2020 [2]. The strategy is defined so that the education system should provide the basic foundation of life and development of each individual, society and state based on knowledge. The Action Plan for the implementation of the Strategy for the Development of Education in Serbia by 2020 specifies individual actions and as one of the key parts of this plan is the Strategy for the Development of Primary and Secondary Education.

Bearing in mind the continuation of technological development and the potential lack of qualified IT experts, the quality of information technology teaching process becoming more important.

Information technology is being taught in all analyzed secondary schools, through one or more subjects, and it should provide knowledge to students in three dimensions - on the conceptual plan and acquired skills. Depending on the educational profile, there is more or less IT content in appropriate subjects, with more or less practice.

There are many research papers dealing with knowledge and skills of pupils in secondary schools [3,4,5]. Also, some of them analyze teachers' aspects in Information technology teaching process [6,7].

The teachers of IT subjects in high schools have very important role in education of future IT experts. Their skills and knowledge have essential importance in education in high schools. The main goal of research is analysis of teachers' assessments of knowledge in IT and also their evaluation of importance of different IT fields for their professional engagement.

## II. METHODOLOGY

Research was done in in the school year 2016/17. The research sample included 246 teachers of informatics form different schools and cities in Serbia. The participants are from public and private schools. The teachers from 22 cities from Serbia were included in the research.

Following types of high schools were analyzed:

- 1 - Electrotechnical school
- 2 - Electrical-traffic technical school
- 3 - Highschool
- 4 - Machine traffic school
- 5 - Mechanical-electrical engineering
- 6 - Mechanical-technical school
- 7 - Technical school
- 8 - ITHS (Highschool for IT)

Research tasks were set in the following order:

1. Choosing a sample;
2. Creating a questionnaire;
3. Conducting the research and
4. Analyzing the results.



Hypothesis of this research was defined in the following manner:

1. Teachers have different assessments of knowledge in the IT field.
2. Teachers differently evaluate the importance of the different IT fields for their professional engagement.

For the purpose of detecting differences authors have used ANOVA. (Analysis of Variance). Analysis of Variance (ANOVA) is a parametric statistical technique used to compare datasets. It is used to compare means and the relative variance between them.

### III. RESULTS AND DISCUSSION

In order to get results about characteristics of different groups one factor of variance analysis was performed (ANOVA).

Table I gives Levenov test of variance homogeneity. According to given results in Table 2 equality of variances of all groups could be analyzed. The Sig. values are not smaller than 0,05. That means that

homogeneity of variance is not violated.

Table II gives the sum of squares of residuals of results from their average values and the number of degrees of freedom for analysis between groups and within groups. The column Sig. gives information about potential significance between groups. The value of Sig. is bigger than 0,05 for most of categories, but for some of them are smaller (35.060).

TABLE I. TEST OF HOMOGENEITY OF VARIANCES

	Levene Statistic	df1	df2	Sig.
35.020	2.059	7	236	.079
35.030	.923	7	236	.489
35.060	1.100	7	236	.050
35.080	1.759	7	236	.096
35.100	.267	7	236	.966
35.110	1.940	7	236	.064
35.140	1.546	7	236	.152
35.160	1.206	7	236	.300
35.180	1.573	7	236	.144
35.200	1.818	7	236	.085
35.220	1.539	7	236	.155
35.240	2.167	7	236	.038

TABLE II. ANOVA FOR KNOWLEDGE IN DIFFERENT IT FIELDS

		Sum of Squares	df	Mean Square	F	Sig.
35.020	Between Groups	4.474	7	.639	1.525	.159
	Within Groups	98.887	236	.419		
	Total	103.361	243			
35.030	Between Groups	3.245	7	.464	.653	.711
	Within Groups	167.444	236	.710		
	Total	170.689	243			
35.060	Between Groups	17.784	7	2.541	2.394	.022
	Within Groups	250.445	236	1.061		
	Total	268.230	243			
35.080	Between Groups	8.569	7	1.224	1.478	.176
	Within Groups	195.415	236	.828		
	Total	203.984	243			
35.100	Between Groups	4.645	7	.664	.827	.566
	Within Groups	189.372	236	.802		
	Total	194.016	243			
35.110	Between Groups	12.090	7	1.727	1.516	.163
	Within Groups	268.927	236	1.140		
	Total	281.016	243			
35.140	Between Groups	12.820	7	1.831	1.632	.127
	Within Groups	264.868	236	1.122		
	Total	277.689	243			
35.160	Between Groups	8.786	7	1.255	.854	.544
	Within Groups	347.029	236	1.470		
	Total	355.816	243			
35.180	Between Groups	11.872	7	1.696	1.651	.122
	Within Groups	242.489	236	1.027		
	Total	254.361	243			
35.200	Between Groups	17.942	7	2.563	1.792	.090
	Within Groups	337.611	236	1.431		
	Total	355.553	243			
35.220	Between Groups	8.504	7	1.215	1.253	.275
	Within Groups	228.905	236	.970		
	Total	237.410	243			
35.240	Between Groups	2.933	7	.419	.733	.644
	Within Groups	134.817	236	.571		
	Total	137.750	243			

**International conference on Applied Internet and Information Technologies  
October 3-4, 2019, Zrenjanin, Republic of Serbia**

Table III gives the sum of squares of residuals of results from their average values and the number of degrees of freedom for analysis between groups and within groups. The column Sig. gives information

about potential significance between groups. The value of Sig. is bigger than 0,05 for most of categories, but for some of them are smaller (35.110).

TABLE III. ANOVA FOR IMPORTANCE IN DIFFERENT IT FIELDS

	Sum of Squares	df	Mean Square	F	Sig.
Between Groups	2.689	7	.384	1.606	.135
35.020 Within Groups	56.471	236	.239		
Total	59.160	243			
Between Groups	2.667	7	.381	1.222	.291
35.030 Within Groups	73.563	236	.312		
Total	76.230	243			
Between Groups	2.845	7	.406	.961	.460
35.060 Within Groups	99.795	236	.423		
Total	102.639	243			
Between Groups	4.228	7	.604	1.711	.107
35.080 Within Groups	83.292	236	.353		
Total	87.520	243			
Between Groups	2.972	7	.425	1.167	.322
35.100 Within Groups	85.827	236	.364		
Total	88.799	243			
Between Groups	8.026	7	1.147	2.897	.006
35.110 Within Groups	93.396	236	.396		
Total	101.422	243			
Between Groups	5.691	7	.813	1.547	.152
35.140 Within Groups	123.994	236	.525		
Total	129.684	243			
Between Groups	4.060	7	.580	.875	.527
35.160 Within Groups	156.477	236	.663		
Total	160.537	243			
Between Groups	1.575	7	.225	.446	.872
35.180 Within Groups	119.028	236	.504		
Total	120.602	243			
Between Groups	4.450	7	.636	1.104	.361
35.200 Within Groups	135.861	236	.576		
Total	140.311	243			
Between Groups	4.527	7	.647	1.296	.253
35.220 Within Groups	117.800	236	.499		
Total	122.328	243			
Between Groups	2.926	7	.418	1.510	.165
35.240 Within Groups	65.337	236	.277		
Total	68.262	243			

Bearing in mind presented results it could be discussed in following manner: There is significance difference between IT fields related to knowledge and importance. The significance is analyzed through subjective opinions of teachers in high schools. Regarding knowledge, the participants have subjective opinion which could give difference for 3<sup>rd</sup> field in Information technology: Languages used in information

#### IV. CONCLUSION

Presented research gives possibility to conclude in several directions:

- The difference regarding knowledge is something which could be affected by many factors like previous education of teachers, interests of teachers, circumstances at workplace, etc. The programming is very popular and well paid as a job and it could be potential reason for different assessment of the mentioned field.
- The difference which is related to importance of some specific IT field could be also affected by many factors and should be further examined. The different importance is noticed at Computer networks.

Future work include further analysis of teachers answers in order to conclude about factors which affect on

technology (35.060). Teachers in high schools have different assessments of knowledge in the IT field.

Also, teachers differently evaluate the importance of the IT area for their professional engagement. The difference in importance in IT fields is related to the 6<sup>th</sup> field: Networking (35.110).

#### ACKNOWLEDGMENT

This study was supported by the Serbian Ministry of Education and Science, Project III 44006, Project III 41007 and TP 34009.

#### REFERENCES

- [1] ISO/IEC standards, [www.iso.org](http://www.iso.org) (accessed in August 2019)
- [2] Strategy for the Development of Education in Serbia <http://www.mprn.gov.rs/strategije-2020/> (accessed in August 2019)
- [3] M. Baran, M. Baran and H.A. Efe, "Investigation of highschool students' computer attitudes in terms of certain attitudes," *Western Anatolia Journal of Educational Science*, retrieved from: [http://webb.deu.edu.tr/baed/giris/baed/ozel\\_sayi/269-276.pdf](http://webb.deu.edu.tr/baed/giris/baed/ozel_sayi/269-276.pdf), pp.269-276.
- [4] T. Assefa, P.C.Rogers, "Integration of ICT in Education: the Plasma Mode of Education in Ethiopian High Schools," retrieved from: <http://citeseerx.ist.psu.edu/viewdoc/download?doi=10.1.1.583.7903&rep=rep1&type=pdf>
- [5] L.Miranda, A.Sacristan, "Digital technologies in mexican highschools," *Technology: Research reports*, retrieved from: <https://files.eric.ed.gov/fulltext/ED585038.pdf>, pp. 1097-1102.
- [6] J.S.Chen, "A Critical Reflection on Integrating Informational Technology Into EFL Curriculum: An EFL Teacher's Inquiry," *US-China Education Review A* 4 2011, pp. 464-470.
- [7] S.Stauffer, "High School Teachers' Perceptions of Cyber Bullying Prevention and Intervention Strategies," PhD thesis, 2011.

# Heterogeneity of Electronic Healthcare Records as Driving Force for Unifying RDBMS and NoSQL Data Stores for the Best Patient-Doctor Outcomes

S. Gračić

University of Novi Sad, Faculty of Economics, Subotica, Serbia  
saritta4u@gmail.com

**Abstract** - Electronic health (care) records (EHR) are heterogeneous in nature and their growth is measured in exabytes. They include demographic information, as well as hand-free notes, medical history, videos, images etc. Because traditional RDBMS are not designed to deal with that level of complexity, research and practice have developed a new data modeling paradigm – NoSQL - for storing semi-structured and unstructured medical data. NoSQL data stores' performance is generally considered better than performance of RDBMS. However, data safety and privacy of NoSQL data stores are still a major issue. The focus of this research is to investigate if data safety can be achieved while still maintaining the ability to efficiently manage heterogeneous data. Are RDBMS really not working for healthcare anymore and can they be combined with NoSQL? To answer this question, literature review was conducted using KOBSON and Google Scholar. It was determined that, for now, the best approach would be to unify these two paradigms in healthcare, thus providing the best of both to patients and medical professionals.

## I. INTRODUCTION

### A. *Data is Getting Bigger by the Second*

The Internet of Everything, social media, multimedia etc. have led to creation of large volume and variety of data. E.g. there are 2.3 billion active Facebook users in 2019, which generate a lot of data. By 2020, each person will generate 1.7 megabytes of data in a second [1].

Generated structured, semi-structured and unstructured data have “overwhelmed the community” and are denoted as Big Data in modern data science [2].

Only 0.5% of generated data were analyzed in 2012 [1]. However, organizations became aware of the importance of these data. This awareness has led to the fact that nowadays 97.2% of them invest in Big Data and Artificial Intelligence [1]. E.g. by collecting various user-generated data and by improving the recommendation algorithm, customer retention in Netflix has grown, resulting in 1 billion dollar savings per year [1].

Big Data is becoming more essential for medical breakthroughs as well, because medical data can be collected from various sources; electronic health (care)

records can be enriched with data generated by wearable devices and results from various genetic tests [8].

These sources will lead to astronomic growth in healthcare data from 153 exabytes in 2013 to 2,314 exabytes in 2020 [8].

Rapid growth of semi-structured and unstructured data has put relational database systems to the test. Traditional, relational database management systems (RDBMS) were initially designed for structured data and were strongly focused on fast querying and data consistency; their further development has led to unprecedented reliability, stability and support [3].

However, data created by users on Facebook, YouTube etc., data generated by sensors, medical systems etc. have shown that RDBMS cannot cope with the amount, variety and processing demands of the Big Data phenomenon [3].

That is why a new class of data storage, named NoSQL (Not Only SQL), emerged, offering horizontal scalability and higher availability by sacrificing query options and consistency guarantees, as opposed to traditional RDBMS [4].

Data expansion of this magnitude requires infrastructure that is large, efficient and scalable to be able to deal with new challenges in data management. Apart from the state-of-the-art hardware and software, it requires high maintenance efforts as well [2].

Organizations seek to decrease these costs (hardware, software, maintenance, IT employees) by relinquishing database management to cloud providers in form of Database-as-a-Service model, due to providers' pay-per-use pricing policy. This enables organizations to decrease their expenditure and reallocate financial resources to their core business.

### B. *NoSQL vs. RDBMS*

NoSQL databases were not designed to substitute, but to complement traditional RDBMS, when later are inadequate [5]. NoSQL databases offer simple, flexible architecture for handling voluminous and various data [6]

and, because of available, reliable and scalable nature, are becoming the first choice for cloud applications [7].

There are many varieties in NoSQL databases – with specific functions and from different vendors [9], but generally, there are four types of NoSQL data stores: key-value stores, wide-column stores, document stores and graph stores.

#### 1) *Key-value Stores*

Key value-stores or databases are based on pairing a unique alphanumeric key with associated values in standalone hash-tables [9]. Since this model is simple, these databases have extremely high performance and are highly scalable for session management and caching web apps [10].

They are useful for fast value retrievals [9] and work with RAM, SSD and disk drives [10]. Typical representatives are Aerospike, Berkeley DB, MemcacheDB, Redis, Riak [10] and DynamoDB [9].

#### 2) *Wide-column Stores*

Wide-column stores are used for distributed storage of huge amount of data [9]. Data tables are organized as columns; querying large quantity of data is faster than with RDBMS [10].

They have timestamp option which is useful for data version management and they also have applications for predictive analytics [9]. These data stores can be used for recommendation engines, catalogs, fraud detection [10]. Examples are GoogleBigTable, Cassandra and HBase [10].

#### 3) *Document Stores*

Document stores are used for semi-structured data and their descriptions in document format [10]. Every document can have hundreds of attributes and different data types [9].

Programs can be created and updated without referencing master schema. JavaScript and JavaScript Object Notation (JSON) have increased the use of document stores, although other data format such as XML [10] and BSON [9] can also be used.

Document stores are used for content management and mobile application data handling. Couchbase Server, CouchDB, DocumentDB, MarkLogic and MongoDB are typical document stores [10].

#### 4) *Graph Stores*

Graph stores organize data as nodes (that are equal to records in RDBMS) and edges (connections between nodes). This type of NoSQL databases gives richer data presentation, because it also stores relationships between nodes and graph data model can evolve over time and with use [9], [10].

They are implemented when mapping relationships is necessary e.g. reservation systems [10], rather than data itself [9]. Examples are AllegroGraph, IBM Graph, Neo4j and Titan [10].

After the Introduction, the rest of the paper is structured in the following order: section II presents previous research regarding comparison of NoSQL

technologies, as well as differences in opinions of various authors regarding performance and security of NoSQL databases and RDBMS; section III presents problems in focus of this research, research questions and applied methodology for providing the answers; section IV presents comparison of NoSQL and SQL in the field of healthcare; section V explains the meaning of heterogeneity of EHR, discusses pros and cons of NoSQL and SQL in healthcare and provides answers to questions in focus of this research. Conclusion is given in section VI.

## II. PREVIOUS RESEARCH

Internet of Everything, social media, Big Data etc. are challenges which RDBMS were not designed to handle in the first place. This has opened space for the development of novel, NoSQL databases, which were designed to store and handle large quantities of various data.

According to Couchbase survey conducted in 2012, majority of participants stated inflexibility of RDBMS as a reason for adopting NoSQL, 35% of them stated scalability, while 29% of participants stated performance, as referred to in [11].

In [12], authors advocated transitioning from traditional, relation-based business intelligence model to agile business intelligence model, which can utilize semi-structured data, as well as structured data. They also stated that in-memory technology should be adopted for the purpose of increasing processing speed.

Facebook, LinkedIn, Amazon, Google are just a few examples of companies that have adopted NoSQL databases [9].

Numerous studies were conducted regarding comparison of different NoSQL databases, among themselves or with RDBMS.

In [18] several SQL and NoSQL databases were compared regarding concurrency control, data storage, replication and transaction support. Authors in [19] compared 6 NoSQL databases. Both [18] and [19] neglected graph stores in their research.

However, comparison presented in research [20] included this type of NoSQL databases (graph stores), focusing on data partitioning and replication in 14 databases.

Orend also compared several NoSQL databases and chose MongoDB, because it supports queries on multiple fields [21].

Determining which NoSQL database was the best, was also done in research [22]. These authors first chose 4 main database providers and then the best database each of those providers had to offer: Amazon's Neptune, Microsoft's Cosmos DB, Google's Cloud DB and IBM's Compose for JanusGraph [22].

After that, Amazon's Neptune was chosen as the "overall winner", although the authors emphasized that without a benchmark test, their choice was of subjective nature [22].

However, there are authors who challenge capabilities of NoSQL technologies to handle Big Data and point out that security issues need to be resolved in near future.

E.g. Stonebraker was focused on determining if NoSQL can really satisfy large-scale online transaction processing (OLTP) applications such as online games and gambling sites [13].

In [13] Stonebraker stated that NoSQL is not appropriate for OLTP, because of necessity for maintaining ACID guarantees, which provide data accuracy and integrity. Since NoSQL lacks ACID properties, their absence generates higher demand on the application layer and querying becomes more difficult.

In [14] the same author presented NewSQL, which offers ACID guarantees on one hand, as well as performance and scalability on the other.

In [15] was emphasized that NoSQL technologies have their advantages and disadvantages, and that the best approach would be to combine these technologies to harness benefits and diminish weaknesses of both RDBMS and NoSQL. Although the author in [15] encouraged using both RDBMS and NoSQL technologies, it was stated that there are various problems with this approach, especially since NoSQL is unable to comply with ACID.

Group of authors in [16] tested and compared performance of RDBMS and NoSQL technologies. They came to a conclusion that higher performance of NoSQL systems was not always the case when compared to RDBMS.

When tested, MapReduce data warehouse Hive had lower performance than parallel database system (PDW) by a factor of nine when using the Transaction Processing Performance Council's TPC-H benchmark on a 16TB scale. SQL-CS had higher throughput and lower latency than MongoDB, although both systems were tested with the same numbers of clients [16].

The reason lies in maturity of SQL technologies. However, the authors stated that NoSQL technologies do offer greater advantages in terms of flexibility and sharding than RDBMS [16].

Better performance of RDBMS was also pointed out in research [23], where two authors compared MySQL with 5 NoSQL solutions. The differences came from application data structure and access methods, according to these authors.

Authors in [5] analyzed security issues of 6 NoSQL databases. Their security assessment was based on 5 criteria: authentication, access control, secure configuration, data encryption and auditing. Each criterion was rated with one of three values: high, medium or low.

It was observed that most of the examined NoSQL databases offered either low security or none whatsoever, which is very problematic in distributed environment. Client password authentication is present, while some data stores use SSL/TLS protocols for secure client-server communication; configuration security is

neglected in all examined databases. They concluded that security is still a major issue and that its improvement is a continuous process that should not be stopped at any cost [5].

The importance of data safety and how security breaches can impact individuals and businesses cannot be overlooked.

This was clearly demonstrated in 2013, when Target stores were faced with the theft of 40 million records from an unencrypted database, which held "personally identifiable information" and credit card data. Later, JP Morgan Chase was "under attack" and 76 million homes and 7 million businesses were compromised [17].

As the group of authors in [17] stated, classic cryptography primitives could protect data at storage, but plaintext data are vulnerable during processing, which is very disturbing if databases contain personal information e.g. financial or medical data.

### III. RESEARCH METHODOLOGY

Both data modeling paradigms, RDBMS and NoSQL, have their advantages and disadvantages. One of major concerns regarding NoSQL is security of data-at-rest and during transmission via unprotected network.

Security breaches can have serious consequences for individuals and businesses e.g. identity theft, illegal money transfers etc. Also, the performance of NoSQL databases is not always better when compared to performance of RDBMS.

Healthcare is faced with monumental data growth, due to many medical and technological advances (MRI, CT, medical apps, wearables, genomics etc.) and healthcare facilities have implemented NoSQL technologies.

However, the above stated problems regarding NoSQL focused this paper on questioning the adequacy of NoSQL technologies in this field, because of potential risks to sensitive patient data.

To examine whether NoSQL technologies are or are not appropriate solution in healthcare, three research questions will be in focus of this paper: **Q1: How suitable are NoSQL databases for the field of medicine and for which purposes?; Q2: Are there any circumstances where RDBMS would be a better option and why? and Q3: Which database modeling paradigm is generally better suited for electronic health records and data collected from medical devices, wearables and apps and why?**

To answer these questions, literature review has been conducted using two scientific databases: Google Scholar and KOBSON. Focal point was on Google Scholar.

Key words – NoSQL in medicine – were used for searching scientific articles in Google Scholar. The search gave 4,320 hits.

Key words "NoSQL", "SQL", "medicine" and "comparison" were set as criteria in KOBSON and the search resulted in 577 hits. Articles that did not refer to

all given criteria or that did not have full access, as well as news were eliminated.

#### IV. NOSQL AND SQL IN THE FIELD OF HEALTHCARE

Authors in [24] designed and implemented a virtual file system using NoSQL MongoDB into SS-MIX (Standardized Structured Medical Information Exchange), which is a standard repository for HL7 messages, but it has limited scalability. This system integrates local patient IDs from various healthcare systems into a universal one. MongoDB has 10 nodes, one for routing server processes, one for mediation among sharding nodes and clients, while the rest of the nodes are used for processing distributed data. Tool for converting HL7 messages in BSON was developed (since MongoDB uses this notation). HL7 separators were decomposed and arranged according to hierarchical structure of the BSON document and patient ID, institutional ID and message type were extracted. The virtual file system was developed using Filesystem in Userspace (FUSE). The average size of HL7 and BSON messages were 824 and 3568 bytes, respectively. With 100 million HL7 messages stored, MongoDB's size was 332.29 GB. Registration performance increased until four nodes were reached, afterwards, it remained constant. With increasing number of concurrent connections, registration performance improved, until it reached 34 simultaneous connections, after which it reached a plateau. Number of bulk-transferred messages did not influence the overall performance. MongoDB's performance was degraded when 30 million messages were stored in a single node. According to the authors, 55 nodes would be sufficient for processing one billion HL7 records from all healthcare institutions in Japan [24].

Authors in [25] compared performance of Oracle 11g SQL and Neo4j NoSQL databases. Neo4j is a graph database, which means that, apart from storing database objects, it also stores relationships among those objects. This NoSQL data store showed good performance for large data and "connected nature of data". Performance of this graph database became much better with the growth of data size and number of join operations. In the first set of experiments, the Oracle 11g SQL database was not physically tuned and times for executing queries were high when compared to execution times for Neo4j NoSQL database. In the second set of experiments, physical database tuning was applied for querying in Oracle 11g SQL database. This resulted in decrease in time necessary for query execution when compared to times for Oracle 11g SQL database without physical tuning. However, query execution times for Neo4j were still lower. Approximately 50% performance increase was noted in the relational database due to physical database tuning technique (Tablespaces). Therefore, these experiments have shown that, despite physical database tuning (Tablespaces) of Oracle 11g, Neo4j had better performance in both sets of experiments [25].

Authors in [26] evaluated how suitable are NoSQL technologies for managing electronic health records (EHR). NoSQL data stores are based on horizontal scalability that allows easy and automatic scaling of large amount of data. Size of medical data has increased over

time and that size has become a bottleneck in managing EHR, which include notes, images, video etc. This heterogeneity demands flexible data models, which NoSQL databases are designed for (easy storage of semi-structured and unstructured data). Medical data should always be accessible when providing care and NoSQL databases provide high data availability, because of their distributed nature and data replication. Healthcare professionals usually add data; updates are not that frequent, so eventual consistency of NoSQL databases is seen as acceptable for EHR. Sharing data requires multiple location access to EHR, which requires a high-performance system and NoSQL databases offer higher performance than RDBMS. However, they also state that there is no unanimous agreement regarding superiority of NoSQL over RDBMS [26].

Authors in [27] presented a Cloud based NoSQL database (as Database-as-a-Service model) of pulmonary nodules for computer aided diagnostics of lung cancer. They stated that computer-aided diagnostics does not have enough shared medical reference data for developing, testing and evaluating computational diagnosis methods. MongoDB was chosen for "its high parallel processing power" and "high performance on data retrieval" and GridFS was chosen for storing images. Database had 379 exams, 838 nodules and 8237 images; 4029 of them were CT scans and 4208 were manually segmented nodules and the database had 4 document collections: exams, images.files, images.chunks and nodules [27].

Authors in [28] performed suitability analyses of NoSQL databases for storing medical images. Digital Medical Images, important for diagnosis and treatment, are obtained from different sources (such as Color flow Doppler, Computed radiography, CT, Digital Subtraction Angiography, Digital Radiography, Mammography, MRI, Nuclear Medicine, Positron Emission Tomography – PET, Ultrasound, X-Ray). These images are stored in DICOM (Digital Imaging and Communications in Medicine) format and all of the above stated modern medical imaging systems support and use DICOM, which also stores images' demographic data. Storing and retrieving this type of data is becoming more challenging (e.g. high-resolution MRI's size is greater than 100MB). Medical informatics is leaning towards the Cloud, where the storage and maintenance are sole responsibility of cloud providers. Managing medical images using RDBMS is not a good option. Therefore, the authors in [28] chose two NoSQL databases, MongoDB and Cassandra. Their results have shown that time complexity for Cassandra was lower as opposed to MongoDB, when storing and retrieving files of smaller size. However, with the increase in file size, time complexity for MongoDB remained constant. It was observed that time complexity for Cassandra increased proportionally with file size growth. They concluded that both NoSQL databases were good candidates for storing medical images in DICOM format, with the observation that Cassandra is a better candidate for smaller-size files, while MongoDB was more appropriate for storing large medical images [28].

Authors in [29] presented their portable smart medical dispenser and corresponding app. They used Firebase

NoSQL database and Real-time Database available on the Cloud. Firebase NoSQL database was used for storing pill details and alarm time entered from Android app. This information is sent to the microcontroller by the Firebase at appropriate time to trigger the motor [29].

In a study conducted in [30], authors developed two archives based on MongoDB and CouchDB and compared their performances using medical images. Their research showed that these two NoSQL databases had similar performances for storing and retrieving images in DICOM format. Both had some drawbacks when storing big files like XA or high-resolution mammography images. However, retrieving performance for these files did not degrade drastically with the increase in file size – this was noted for MongoDB, CouchDB and Lucene. For future research, authors will change search engine to support more robust replication schemas [30].

In [31] authors wanted to improve performance, which was degraded in translational research data storage databases, because of the increasing volume of produced data. Research results demonstrated that key-value pair schema increased performance when querying high-dimensional biological data, as opposed to relational model implemented in tranSMART. Their implementation of the tranSMART DEAPP schema using HBase outperformed MySQL Cluster as well as MongoDB [31].

In paper [32] authors described a system for handling many genomic variants in a hospital environment where clinical research data are managed by the i2b2 (Informatics for Integrating Biology and the Bedside) framework. Integration of phenotype and genomic variant profiles has two steps: first - cohorts are generated by querying clinical terms using the i2b2 built-in functionalities; second - the cohort is uploaded to the BigQ-plugin to retrieve the corresponding genomic variants of interest”. Variants were annotated with ANNOVAR software and stored in CouchDB document-based NoSQL. “The data are then managed by a dedicated i2b2 cell and a visual-programming plugin for easily performing queries”. The system can deal with variants of unknown clinical meaning, possibly characterized by useful but heterogeneous biological data. Therefore, data model is flexible; database can be easily updated with new versions of the variant annotations. Query system demonstrated good performance with the database volume, which makes it adequate for querying clinical and genetic data together [32].

In [33], infrastructure for exploiting Big Data to overcome limitations of relational databases when working with large and heterogeneous data was presented. The infrastructure implemented a set of interface procedures for preparing the metadata for importing data in a NoSQL database. Performed tests on large data volume showed that the infrastructure’s performance could not have been achieved with relational databases. These performances are related to indexing any type of field and query customization. High flexibility in customizing queries increased search performance and specificity of results [33].

RDBMS are based on predefined structure and use SQL for queries; EHR are designed in the same way; but NoSQL databases allow e.g. document based records to be stored. For NoSQL databases, data are stored in documents like JSON which can be imported to the database. EHR are increasing horizontally and require horizontal scaling. SQL and NoSQL can scale vertically. SQL cannot scale horizontally [34]. It stated in [34] that NoSQL is better for building EHR, because costs are 10 times lower than when building EHR with SQL and they can scale horizontally.

In [35], authors formed several conclusions. RDBMS and NoSQL document stores show linear behavior with database growth. However, RDBMS show much steeper slope than NoSQL. This means that, if the amount of data is not very big, RDBMS perform reasonably well, but if data growth is extremely high (e.g. epidemiological queries on secondary use), NoSQL databases will be a better solution. MongoDB performs considerably better than native XML NoSQL database. Visualization and edition of medical information is a document-based task, for which NoSQL systems are designed and therefore will perform better. NoSQL data stores surpassed RDBMS under a concurrent execution regime, in throughput and in query execution time. MongoDB behaved better in concurrency than in isolation [35].

Authors in [36] stated that EHR are different, because patients are allowed to create and manage their medical data and share that data with healthcare providers, labs, specialists etc. Neither RDBMS nor NoSQL data stores can manage all the requirements of a complex healthcare system on their own. Geospatial visualization is just an additional benefit for patients. That is why they investigated the benefits of uniting RDBMS (MySQL) and NoSQL document-store MongoDB with QGIS for developing better EHR and Clinical Decision Support Systems (CDSS). Apart from the above stated elements, their solution has two more components: web interface for querying and retrieving information and API (Application Programming Interface) which communicates with users (front end) and databases (back end) [36].

The ACID (atomicity, consistency, isolation, durability) properties of RDBMS provide “data integrity, database security, efficient SQL queries, easy data access and effective transaction processing”. MongoDB provides “clear internal data structure, easy scaling-out, fine-tuning, and convenient mapping of application objects to the database objects”. The GIS visualizes geographic locations of patients, physician offices and medical facilities. This system is compliant with HIPAA (regarding data privacy and safety) without compromising scalability and performance [36].

## V. DISCUSSION

### A. *Specific Nature of Medical Data*

EHR have very specific nature, because they contain various data in type and size, from bills to MRI images. That is way they are heterogeneous [36]. Heterogeneity



means that EHR contain all three types of data: structured, semi-structured and unstructured [36].

#### 1) *Structured medical data*

Structured data are characterized by very similar structure and high stability. Because of these features, this type of data can be efficiently modeled using RDBMS [36].

Structured medical data include various patient-doctor-facility demographics, appointments and administrative data. In detail, these include:

- Basic patient information - age, gender, race, address, contact information, etc.
- Basic personnel information – education, training, board certifications, contact information, associated medical facilities, etc.
- Basic medical facility information - address, contact information, size, bed capacity, number of employees, number of different medical professionals, associated medical groups, etc.
- Clinic appointments - appointment dates, when they were made, the exact time and duration of each appointment and the status of each visit.
- Billing information - patient account balance, expenses, payments, credit card and insurance information.
- Immunization records - names, dosages and means of delivery.
- Insurance information, referral information and other line-of-business data [36].

#### 2) *Semi-structured medical data*

Semi-structured data are characterized by similarities as well as differences among stored records. Some of the semi-structured data could be modeled using RDBMS, but some could not [36].

Semi-structured data include:

- Allergies – patients with different or even (the) same medical condition(s) could have different allergic reactions and will require diverse and different medications. RDBMS schema cannot deal with this level of complexity and provide efficient searches.
- Medical histories – different patients can have one or more chronic diseases and different medicaments will be necessary for treatment of those patients, thus making medical history hard to model with RDBMS.
- Lab results - different tests, different samples, various measurement units and different instruments add more complexity to EHR. Different lab instruments can produce different outcomes for same samples.
- GIS information – geographic longitude and latitude can be modeled in a RDBMS, but

visualization of geographic data such as maps with directions and distances, cannot [36].

#### 3) *Unstructured medical data*

EHR contain a significant amount of unstructured data which include hand-written doctors' notes regarding observations, diagnosis, recommendations and other data that are both visit- specific and patient-specific. There are also voice recordings, videos [36] and images (CT, X-ray, MRI etc.) stored in DICOM format [28], [36].

Secondly, EHR are designed for doctors and patients as well. Patients can create and share their medical data with medical professionals, labs, specialist etc. [36].

Thirdly, because of their sensitive nature, EHR have to be secured to protect patients' privacy. This means that when medical data are stored, developers have to incorporate HIPAA into database design, that is, database has to be HIPAA compliant.

#### B. *Why or Why Not Shift Towards NoSQL?*

Due to the expansion of medical data, which is already measured in exabytes [8] and will continue to grow in the future, a shift in data modeling paradigm can be observed. A lot of researchers are advocating for major transition in data management – from SQL towards NoSQL data stores [9], [11], [12].

Reasons for doing that are seen in the horizontal scalability of NoSQL data stores [4], [26], [34], which is very important in managing healthcare data due to its constant growth [8] and the EHR's necessity for horizontal scaling [34], availability of data [4], [7], [26] in real time, simple data modeling schemas [31], [36], better performance [16], [18] and operating in distributed environments [5], [9], [20], [24], [26].

To test whether NoSQL data stores are better (or not) than RDBMS, researchers have compared performances of these two database modeling paradigms [13], [14], [16], [18], [23], [35]. However, there were authors who proved that RDBMS outperformed NoSQL databases [13], [14], [23] and it was also stated that RDBMS perform quite well if data size is not big [35].

Also, a lot of experiments were conducted to compare performances among various NoSQL data stores [19], [20], [21], [22], [25], [28], [30]. Many authors chose MongoDB as the best for their research purpose [21], [24], [27], [28], [35], although HBase outperformed MongoDB in [31].

Authors who either compared SQL with NoSQL, or NoSQL solutions among themselves, did not mention security issues related to NoSQL databases, except [5], [13], [14] and [17]. Security and data privacy issues are very important and whichever database is chosen, it has to be designed to be HIPAA compliant.

#### C. *Focus on the EHR Heterogeneity*

As previously stated EHR are of heterogeneous nature and are consisted of structured, semi-structured and unstructured data [36]. They include information regarding patients, medical professionals, medical facilities and other medical-related data.

Because of this variety, structured data can be modeled using RDBMS, while semi-structured and unstructured data have to be modeled in NoSQL data stores, so the authors in [36] created a combined DB system with RDBMS (MySQL) and NoSQL (MongoDB) to use the best from both data modeling paradigms for managing EHR.

The focal point of this research was to examine whether NoSQL technologies are indeed an appropriate solution for storing medical data that vary in type and size and are growing exponentially.

This research showed that many authors neglected the fact that one part of electronic healthcare records is structured and could be stored using RDBMS.

Based on the conducted literature review, several observations in form of answers to research questions regarding SQL and NoSQL can be made. As far as the first research question **Q1** (*How suitable are NoSQL databases for the field of medicine and for which purposes?*) is concerned, it can be stated that NoSQL databases are suitable for the medical field for structured, semi-structured and unstructured data. This type of database can store structured data such as demographics of patients, doctors, medical facilities, patient appointments, as well as hand-free notes, videos, images and other medical related semi-structured and unstructured data.

As far as the second research question **Q2** (*Are there any circumstances where RDBMS would be a better option and why?*) is concerned, data safety and privacy are still problems in NoSQL data stores, so the author of this paper agrees with the authors in [36], who were the only ones who focused their attention towards security and HIPAA compliance. Until safety issues in NoSQL environment are not resolved, for now, the best approach is to store structured data into RDBMS, while semi-structured and unstructured data should be stored in NoSQL data stores.

When it comes to research question **Q3** (*Which database modeling paradigm is generally better suited for electronic health records and data collected from medical devices, wearables and apps and why?*), it could be concluded that, if providers of NoSQL data stores would work on data safety and privacy, NoSQL would be a better solution for EHR for two reasons. The first one is that NoSQL data stores offer horizontal scalability, availability and are better suited for operating in distributed environment than RDBMS. The second is that semi-structured and unstructured data coming from medical devices (X-ray, MRI, CT etc.), apps and wearables (O2 saturation, sinus rhythm, contractions etc.) will continue to grow and in 2020 will reach astonishing 2,314 exabytes [8].

## VI. CONCLUSION

EHR have to be HIPAA compliant and modeling medical data in RDBMS provides this compliance. However, the heterogeneous nature of EHR makes it impossible for RDBMS to deal with the level of complexity related to semi-structured and unstructured

medical data. On the other hand, new data modeling paradigm – NoSQL can deal with these two data types, which are important for providing healthcare professionals necessary information for decision making on point of care (POC) and creating the best clinical outcomes. However, NoSQL technologies were developed without considering data safety and privacy, which creates conflict with the HIPAA standards.

The focus of this research was to determine whether RDBMS are or are not appropriate for EHR anymore and if they can be combined with NoSQL for the best patient-doctor outcomes. The author of this paper conducted literature review using Google Scholar and KOBSON to answer 3 research questions regarding suitability of NoSQL and RDBMS for EHR.

Research showed that, with the current development of NoSQL, if data safety and privacy are to be ensured, while still maintaining their flexibility and availability, structured data should be stored in RDBMS, while semi-structured and unstructured data should be stored in NoSQL database.

NoSQL data stores are characterized by horizontal scalability, availability, simple architecture, better performance and the ability to operate with all 3 data types. Another important feature is that modeling EHR in NoSQL generates costs that are 10 times lower compared to modeling EHR with SQL. By further improving safety measures in NoSQL databases and adding ACID properties, it is high likely that NoSQL databases will substitute RDBMS in the field of healthcare in the future.

## REFERENCES

- [1] "Big Data Statistics 2019", Tech Jury, 2019. [Online]. Available: <https://techjury.net/stats-about/big-data-statistics/>. [Accessed: 11-Sep- 2019].
- [2] S. Sharma, "Expanded cloud plumes hiding Big Data ecosystem", Future Generation Computer Systems, vol. 59, pp. 63–92, 2016
- [3] F. Gessert and N. Ritter, "Scalable Data Management: NoSQL Data Stores in Research and Practice" in ICDE 2016, pp. 1420-1423
- [4] W. Lehner and K.-U. Sattler, Web-Scale Data Management for the Cloud. Springer, 2013.
- [5] A. Zahid, R. Masood, M.A. Shibli, "Security of Sharded NoSQL Databases: A Comparative Analysis", in Conference on Information Assurance and Cyber Security, CIACS, 2014
- [6] C. Roe. "The Growth of Unstructured Data: What To Do with All Those Zettabytes?", 2012 [Online]. Available: <http://www.dataversity.net/the-growthof-unstructured-data-what-are-we-going-to-do-with-all-thosezettabytes>, [Accessed: 28-March- 2014]
- [7] A. Schram and K.M. Anderson. "MySQL to NoSQL: data modeling challenges in supporting scalability," in Proc. of the 3rd annual conference on Systems, programming, and applications: software for humanity, 2012, pp. 191-202.
- [8] Stanford Medicine 2017 Health Trends Report, "Harnessing the Power of Data in Health", 2017. [Online]. Available:<https://med.stanford.edu/content/dam/sm/sm-news/documents/StanfordMedicineHealthTrendsWhitePaper2017.pdf>. [Accessed: 12-Sep- 2019].
- [9] M. Madison, M. Barnhill, C. Napier and J. Godin, "NoSQL Database Technologies", Journal of International Technology and Information Management, vol. 24, 2015
- [10] M. Rouse, "NoSQL (Not Only SQL database)", 2017

- [11] A. M. Moniruzzaman and S. A. Hossain, "NoSQL database: new era of databases for big data analytics – classification, characteristics and comparison", 2013
- [12] M. Muntean and T. Surcel, "Agile BI - the future of BI", *Informatica Economica*, vol.17, pp.114-124, 2013
- [13] M. Stonebraker, "SQL databases v. NoSQL databases", *Communications of the ACM*, vol. 53, 2010
- [14] M. Stonebraker, "New opportunities for new SQL", *Communications of the ACM*, vol. 55, 2012
- [15] D. Ghosh, "Multiparadigm data storage for enterprise applications", *IEEE Software*, 2010
- [16] A. Floratou, N. Teletia, D.J. Dewitt, J.M. Patel and D. Zhang, "Can the elephants handle the NoSQL onslaught?", *Journal Proceedings of the VLDB Endowment*, vol. 5, pp. 1712-1723, 2012
- [17] M. Ahmadian, F. Plochan, Z. Roessler and D. Marinescu, "SecureNoSQL: an approach for secure search of encrypted NoSQL databases in the public cloud", *International Journal of Information Management*, vol. 37, pp. 63-74, 2017
- [18] R. Catell, "Scalable SQL and NoSQL data stores", *ACM SIGMOD Rec.*, vol. 39, pp. 12-27, 2011
- [19] R.P. Padhy, M.R. Patra and S.C. Satapathy, "RDBMS to NoSQL: Reviewing some next-generation non-relational databases", *Int. J. Adv. Eng. Sci. Technol.*, vol.11, pp. 15-30, 2011
- [20] R. Hecht and S. Jablonski, "NoSQL evaluation: A use case oriented survey", *CSC 2011*, pp. 336-341
- [21] K. Orend, "Analysis and classification of NoSQL databases and evaluation of their ability to replace an object-relational persistence layer", Master's Thesis, Technische Universität München, 2010
- [22] B. Iancu and T. M. Georgescu, "Saving Large Semantic Data in Cloud: A Survey of the Main DBaaS Solutions", *Informatica Economică*, vol. 22, 2018
- [23] A. Lith and J. Mattsson, "Investigating storage solutions for large data", Ph.D. thesis, Master's thesis, Department of Computer Science and Engineering, Chalmers University of Technology, 2010
- [24] E. Kimura and K. Ishihara, "Virtual file system on NoSQL for processing high volumes of HL7 messages", 2015, doi:10.3233/978-1-61499-512-8-687
- [25] W. Khan, W. Ahmad, B. Luo and E. Ahmed, "SQL Database with physical database tuning technique and NoSQL graph database comparisons", in *IEEE 3rd Information Technology, Networking, Electronic and Automation Control Conference, ITNEC 2019*, pp. 110-116
- [26] M.Z. Ercan and M. Lane, "Evaluation of NoSQL databases for EHR systems", in *25th Australasian Conference on Information Systems*, 8th -10th Dec 2014, Auckland, New Zealand
- [27] J. Raniery Ferreira Junior, M. Costa Oliveira and P. Mazzoncini de Azevedo-Marques, "Cloud-Based NoSQL Open Database of Pulmonary Nodules for Computer-Aided Lung Cancer Diagnosis and Reproducible Research", *J Digit Imaging*, vol. 29, pp. 716–729, 2016
- [28] R. Rebecca and E. Shanthi, "Analysing the suitability of storing Medical Images in NoSQL Databases", *International Journal of Scientific & Engineering Research*, vol. 7, pp. 527-531, 2016
- [29] S. Samhitha and N.K. Srinath, "Design and development of Portable Smart Medicine Dispenser", *International Journal of Scientific Research in Computer Science, Engineering and Information Technology*, vol. 5, pp. 147-152
- [30] L. A. Bastião Silva, L. Beroud, C. Costa and J. L. Oliveira, "Medical imaging archiving: a comparison between several NoSQL solutions", *IEEE*, pp. 65-68, 2014
- [31] S. Wang, I. Pandis, C. Wu, S. He, D. Johnson, I. Emam, F. Guitton and Y. Guo, "High dimensional biological data retrieval optimization with NoSQL technology", *BMC Genomics*, vol. 15, 2014
- [32] M. Gabetta, I. Limongelli, E. Rizzo, A. Riva, D. Segagni and R. Bellazzi, "BigQ: a NoSQL based framework to handle genomic variants in i2b2", *BMC Bioinformatics*, vol. 16, 2015
- [33] M. Moscatelli, A. Manconi, M. Gnocchi and L. Milanesi, "A Infrastructure for Disease Prevention and Precision Medicine"
- [34] R. Sreekanth, G. V. M. Rao and S. Nanduri, "Big Data Electronic Health Records Data Management and Analysis on Cloud with MongoDB: A NoSQL Database", *International Journal of Advanced Engineering and Global Technology*, vol. 3, pp. 946-949, 2015
- [35] R. Sánchez-de-Madariaga, A. Muñoz, R. Lozano-Rubí, P. Serrano-Balazote, A. L. Castro, O. Moreno and M. Pascual, "Examining database persistence of ISO/EN 13606 standardized electronic health record extracts: relational vs. NoSQL approaches", *BMC Medical Informatics and Decision Making*, vol. 17, 2017
- [36] H. Wu, A. Ambavane, S. Mukherjee and S. Mao, "A Coherent Healthcare System with RDBMS, NoSQL and GIS Databases", in *Proceedings of the 32nd International Conference on Computers and Their Applications, CATA*, 2017, pp. 313-318

# Didactic Design of Multimedia and its Usage in the Educational Process

A. Praskić\*, V. Srdić\*\* and S. Jokić\*\*\*

\* Independent University, Faculty of Pedagogy, Banja Luka, Bosnia and Herzegovina

\*\* International University in Novi Pazar, Pedagogical and Psychological Studies, Novi Pazar, Serbia

\*\*\* International University in Novi Pazar, Computer Studies, Novi Pazar, Serbia

**Abstract** - It is very interesting and complex to define multimedia. The often mentioned progression of information technology causes the definition to be dynamic, vibrant, growing, prone to complement. However, following many definitions, we can say that it is a combination of hardware and software that support reproduction and retention of videos, audios, animations, graphics, records, text, all for the purpose of transmitting information. The aforementioned dynamics in the development of the technology of the 21st century leads to various interpretations. The unique idea for all definitions is that "multimedia represents the integration of several media (video, audio, text, etc.)" that are in synergy and each of them individually complements the image of the information we wish to convey, to present. From the perspective of pedagogical sciences, we use the multimedia in teaching to transmit the information, through integrated media that give width and depth in the presentation of teaching content and enable different forms of work and learning.

**Keywords:** multimedia, didactic design, teaching process, educational software.

## I INTRODUCTION

Today, in the 21st century, the educational process is unimaginable without the use of media, which have become an irreplaceable part of modern teaching. Looking from Komensky to the present, we distinguish didactic

theories in the explanation of the process of learning and teaching, the description of sources of knowledge as well as the teacher-student relationship in the teaching process. In general, the media is the means of transmitting information and in didactics the media is the mediator of information among the participants of the teaching and learning process. Didactics of the media is a discipline that deals with didactic design of teaching media, with its selection and example in the contemporary teaching process. Multimedia becomes an essential part of modern teaching and as such is imposed through the teaching process because it gives students a chance to observe and analyze the objective reality with the naked eye.

E. Dale tried to present the didactic values visually and benefits of various resources at school in the form of a cone of experience, putting at its foundation immediate experiences in the original reality (primary sources), and to the top verbal and visual symbols. A number of other didactically shaped sources situated between other experiences with objective reality and learning from books [1].

With a content-focused concept, the media will have the function of presenting the content and the passive student, and with the student-centered concept, the medium has the function of raising the student's activity.

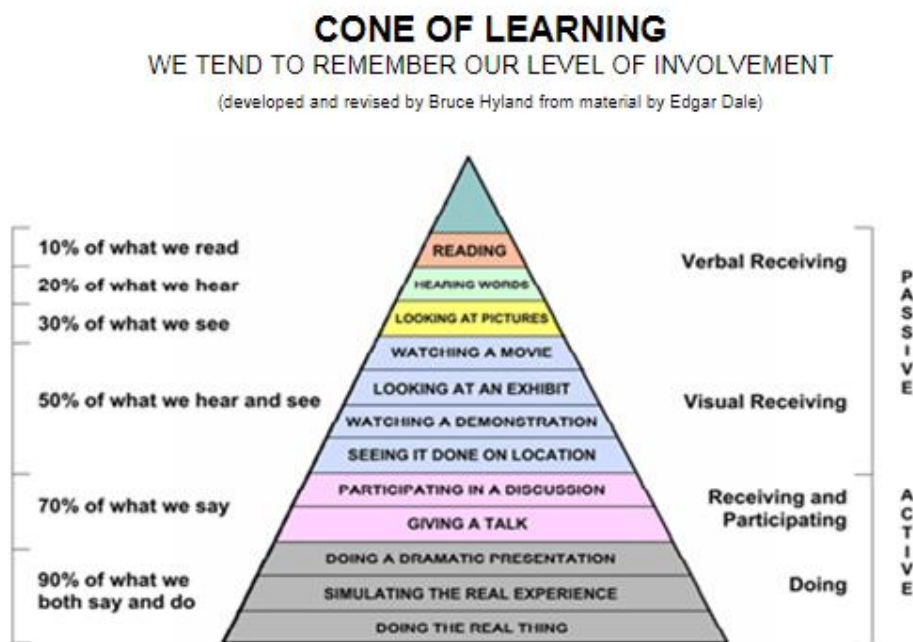

Figure 1 : Cone of experiences (Adjusted by Bruce Hyland at the suggestion of Edgara Dalea, 1969.)<https://studylib.net/doc/18256457/cone-of-learning>

## II. DEFINITION AND IMPORTANCE OF MULTIMEDIA IN EDUCATIONAL PROCESS

In the second half of the 1980s, the use of the media and its influence became greater. Stronger, faster and more accessible computers slowly started taking over the other media. It is not enough to say: multimedia is an extension of PCs, with audio and video capabilities and the equipment for CD-ROM drives [2].

The basic media of display and media are text, images, sound, animations and video. The concept behind the multimedia program is the integration of technology and software. Therefore, the computer is the technical basis, through which voice assignments are issued. Of course it responds verbally as well. Having the Internet in mind, the possibilities are literally endless. We have the possibility to use world-class databases, planetary networks for the purpose of video presentations or to watch different shows. At that point, the computer takes over the role of managing the knowledge and serves as support for the necessary information we need.

Through multimedia, teachers and professors can easily and effectively deliver teaching content in one interesting and innovative approach that students find more interesting than traditional teaching. Multimedia packages are created to help achieve the goals for this occasion.

Students are given the opportunity to learn individually through the principle of obviousness. A new, different approach to teaching material through multimedia packages increases efficiency and approaches the learning process of teaching content in an optimal way.

The use of multimedia in the teaching process is the result of the environments in which teachers and professors work, and students learn, of cognitive learning opportunities as well as various multimedia effects when transmitting information, ie transferring information to the student. Mayer's model [4] is actually a representation of the teaching process with multimedia:

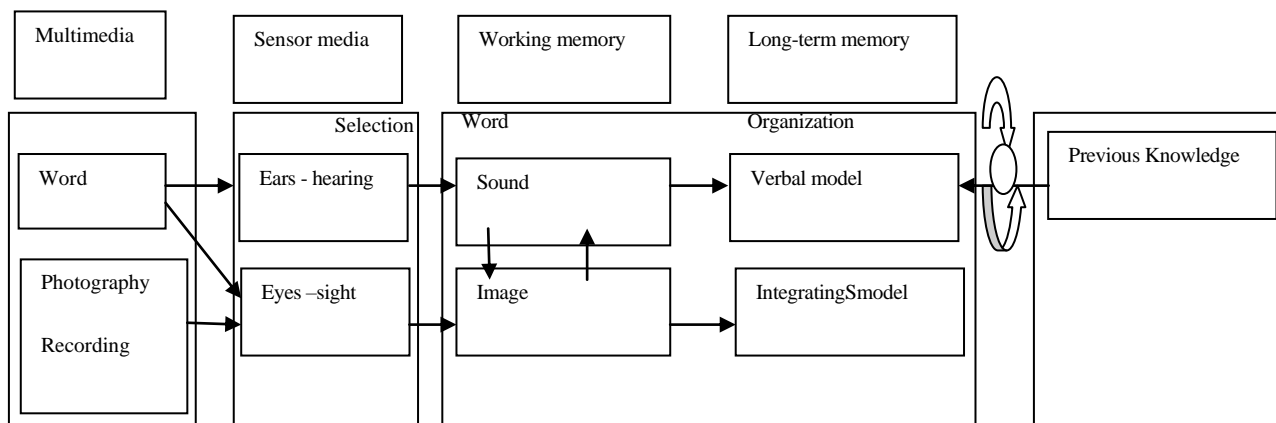

Figure 2: The teaching process with multimedia([4])

It is confirmed that the average student remembers 10% of what they read, 20% of what they heard, 30% of what they saw, 70% based on personal dramatization and records, and 90% when they think about, say, realize. The conclusion is that multimedia-assisted teaching achieves the best results in the teaching process.

### III. TEACHING EFFICIENCY THROUGH THE USAGE OF MULTIMEDIA SOFTWARE AND COMPUTERS

The nineties are also characterized by a shift to simpler programs. From BIOS that was dominant in those days, it was massively switched to windows. Windows simplified the use a computer that even children could easily handle it. The role of computers in education becomes significant.

Teachers responded to the new aid in three ways: the first group was afraid of a new way of education, the second group was delighted with the expansion of use of computers and the computer system in schools, the third group was passive about the implementation of computers in teaching[7].

Disadvantages of traditional teaching can be avoided by using a computer: the student is not a passive receptor; he/she continuously receives feedback on the accuracy of their own answers[6].

When it comes to software, Microsoft office is the most widely used. This simple and functional package meets the needs of various fields of activity. We are much more efficient with the help of software: Microsoft Word (word processing software), Microsoft Excel (spreadsheet software), Microsoft Power Point (presentation creation software), Microsoft Front Page (software for development of the Internet presentations - website)[6].

### IV. APPLICATION OF EDUCATIONAL SOFTWARE IN THE DIDACTICAL TRIANGLE FROM THE ASPECT OF IMPLEMENTATION OF THE INNOVATION IN THE TEACHING PROCESS

Important factors of effective teaching are student activity and the feedback. A well-designed scenario, helped by contemporary didactic media, will improve

student activity. Feedback is a great guide for teachers and professors to help them continue the quality of learning. Student activity and feedback are more or less encouraged and expressed. When selecting activities to achieve effective teaching, it is crucial to choose activities that stimulate one or more senses at the same time. Activities applicable when using the educational software in teaching are: observing, describing, assessing, grouping, recording, practicing, researching, collecting, mini-project activities [8].

The most effective methods of learning in education are those that put the student in an adequate active position in the process of gaining knowledge. When applying software in teaching (or software planning) the most important pedagogical principles are: obviousness, from closer to further, from simple to complex, from concrete to abstract, individualization.

The self-advancement of students is also enabled by a various selection of educational programs. The teacher's task will be expanded to two areas: to organize and design the learning environment and provide help and motivation for the student, to strengthen his/her knowledge[2]. The teacher, who is constantly learning and improving in modern teaching, has the task to balance technical capabilities and the classical way of learning. The teacher is now a guide, counselor, motivator, person who manages and directs.

#### *A. Impact on teaching content*

Unlike classical teaching, contemporary teaching does not recognize the teacher and the textbook as the only sources of information. Information technology provides endless sources of knowledge. In most cases, multimedia is the bond. Its impact on teaching content makes it closer, more sensible to the student, and multimedia itself encourages the student to explore, master, learn, memorize, apply. By using multimedia, the content is richer, and more senses get activated in touch with the instructional content. Teachers and professors can easily connect the contents of several subjects through presentations, software packages and the Internet, and with good education, a new opportunity opens up - thematic planning of the curriculum of several subjects

connected as a whole through modern multimedia within the planned classes and subjects for that specific day.

***B. Impact on the student***

In the 21st century, from a classical object, a student becomes a subject, a significant teaching factor that actively participates in the teaching process, he/she initiates their cognition system and, according to the

potentials, takes over the information systems, facts, concepts that are offered to him/her... Meyer and associates [4] have explored the impact of multimedia on learning for decades. The results of the multimedia application are shown in the table as follows:

**TABLE 1: EFFECTS OF MULTIMEDIA APPLICATION ON THE LEARNER [4]**

<b>Empirical results</b>	<b>Practical applications, multimedia</b>
Multimedia principle: Students learn better with images and words than with words only.	On-screen animations, presentations, slides, and narration should include both written or spoken text and moving or fixed images. Research shows that it is less effective if text or narration is not supported by visual elements.
Spatial constraint principle: Students learn better when the content they correspond to (words, images) are arranged closer than spaced on the screen	When displaying text and images together, the text should be closer to or near the edge of the image. It is most effective to put text in the image itself.
Time limit principle: Students learn better when words and pictures are presented at the same time rather than successively.	When displaying a combination of image and text, they should be displayed at the same time. When used with animation and narration together, they should match meaningfully.
Coherence principle: Students learn better when excessive words and pictures are turned off than present.	Multimedia approaches should focus on clean, concise content presentations. Any insertion of disruptive non-functional sounds, external information, impairs learning.
Modality principle: Students learn better from animations and narratives than from animations and text on screen.	Multimedia views that include words and images should be designed in such a way that audio or narration is used instead of the written text followed the image.
Redundancy principle: Students learn better through a combination of animation and narration than through a combination of animation, narration and on-screen text.	A multimedia approach that contains both words and images should display the text either in written form or in audio form, not in both forms, as this distracts the student's attention and focus. The student becomes overwhelmed with perceptions.
The principle of individual diversity: The effects that multimedia design has on students are greater for students with less knowledge, while for students with greater knowledge design has less impact. They also have a greater impact on visually-oriented students.	Named strategies are most effective for beginners, students in lower grades; for students with less knowledge and ability; for students who visually remember. Therefore, such multimedia approaches should be purposefully created and implemented.

**VII. INTRODUCTION AND EFFECTS OF APPLICATION OF DIDACTICALLY-DESIGNED MEDIA IN THE TEACHING PROCESS**

During the teaching process, students should develop and establish systems of scientific concepts. It implies the process of mastering a knowledge system that enables navigating through different levels of knowledge as well as incorporating new innovative ways of teaching, the process of getting deeper into the paths of the student's knowledge, interestingness of display, new content choices, a new profound approach to content, order of introduction of terms, and finally bringing the knowledge and concepts into one whole. The research and discovery way of teaching and the way of active obviousness during the processing of concepts and facts in elementary school support children's curiosity. Multimedia, as an innovative model of content processing, greatly improves the demanding forms of teaching and the complexity of the matter that the students encounter with in the teaching process which does not often sufficiently accompany the mental activity of a child. The content of knowledge within the content of teaching remains at the level of superficial knowledge and some general ideas and only knowledge of the external properties of objects and phenomena is followed. The role of didactically shaped media is precisely to guide towards innovative ways of

teaching, a schedule of processing certain content, and even the approach to a specific content. During the teaching process, students interact with the content they need to adopt and in doing so, a positively innovated approach to multimedia and technique strategy, can only contribute to the deeper interest and deeper student-content interaction. The visual and auditory effect of such approach to content undoubtedly requires a more lasting and profound effect of memorizing and spotting links in teaching content, successfully applies learning strategies and techniques. The use of media in teaching instead of providing ready-made knowledge and information provides students with a gradual set of necessary information in a system that allows them to independently come up with new knowledge and receive feedback on their work. Each following success is also the next motive for the next segment of the student's work. Multimedia programmed presentations provide students with properly dosed feedback and in the case of failure the return to the essential element of content information. The ultimate objective of this type of teaching represents quality gained knowledge, with a more lasting connotation, which is easily structured into existing cognitive structures, applied, transformed if necessary and used in necessary life situations.

The media in the teaching process is a didactic source of information as well as a communication tool. It is a very important resource of quality primary education and without it, the teaching process of quality education cannot be imagined. The primary role, objective and justification of media didactics as a necessary resource for quality primary education in the new "learning society", ie "information society", is to help increase the success of education and the learning process. The goal of using media in the teaching process as a source of knowledge is to bring the matter closer to students in a "more attractive" way to animate them, to encourage them to be participants in the educational process, not just observers of the same process.

By introducing didactically shaped media into the teaching process, we directly influence the role of a student, who switches into the position of a subject from the position of an object and directly influences the realization of the teaching process. Modernization of the teaching process by the introduction of didactically shaped media is significant [5]: didactically shaped media create conditions for the teacher and the student to be liberated from many routine tasks, students gain knowledge faster and better, they develop abilities more evenly, develop their personality more integrally, the teacher can adjust the teaching more successfully to the student's previous knowledge, interests, cognitive and learning styles, abilities and rate of work, conditions for students to participate more actively in all phases of teaching are created (in organization, realization and verification), to modernize teaching forms, methods and procedures more quickly, assumptions to consistently implement basic teaching principles are also created, they are an important factor in the process of conception, realization and successful completion of the teaching process, encourages students to independently check and expand what they have learned in class, it is possible to implement the basic principles of learning more consistently, it creates better learning opportunities, conditions for a more permanent memory of what has been learned, a more secure recognition and use of what is remembered.

## CONCLUSION

It is necessary to make radical changes in the methodology and organization of teaching in the process of teaching. The traditional way of learning is used in most schools, with minor shifts in the use of ICT technologies. The consequence is slow progress, often linked to the economic development of individual countries. The application of ICT in teaching is not just a technical issue. It seeks answers to basic questions about teaching methods, funding priorities, mission and vision for the school. When defining educational goals, it is necessary to take into account the new opportunities provided by technology, the Internet, multimedia. It is not only an improvement of the environment in which it is used, it is fundamentally changing it. Information and communication skills of the lecturer, who selects the contents and determines the teaching process, are essential and affect the quality of education. An indispensable process that cannot be bypassed is to train and improve teachers, to prepare them for the process of lifelong learning, to follow trends and frequent changes in information and communication technologies.

## REFERENCES

- [1] L. Bognar, M. Matijević, *Didaktika*, Zagreb, Školska knjiga, 1993.
- [2] G. Hegedűs, *Projektpedagógia*, Kecskemét, Kecskeméti Főiskola, 2002.
- [3] V. Lipovac, *Didaktički aspekti multimedijalne nastave*, Sombor: Norma, 2003.
- [4] R. Majer, *Multimedia Learning*, Cambridge, University Press, 2001.
- [5] D. Mandić, N. Lalić, V. Bandjur, *Managing Innovations in Education*, in the book 9th WSEAS International Conference, on artificial intelligence, knowledge engineering and data bases (AIED '10), University of Cambridge, Cambridge, United Kingdom, 2010.
- [6] Zs. Námesztovszki, *Számítógépek az általános iskoláinkban*. In: *Világosság*, 2006.
- [7] C. Raschke, *Digitális kultúra, a harmadik tudásforradalom és a hiperegység beköszöntése*. In: *Világosság*, 1998.
- [8] *Službeni glasnik RS-Prosvjetni glasnik 2004.*, 2006.



# Retrieving Court Decisions Using Text Mining Techniques and Tools

I. Trpovski\*, N. Stojanović\*, T. Orčić\*, M. Marković\*, A. Kovačević\* and S. Gostojić\*

\* University of Novi Sad/Faculty of Technical Sciences, Novi Sad, Serbia

trpovski@gmail.com, stojanovicn129@gmail.com, timotej.orcic@gmail.com, markic@uns.ac.rs, kocha78@uns.ac.rs, gostojic@uns.ac.rs

**Abstract - In this paper, we present a solution for finding similar legal decisions to establish a solid basis for the development of a case-based reasoning system. A court decision corpus was scraped from the web. Features that represent court decisions were carefully selected. Several machine learning methods were applied to extract selected features from court decisions in plain text format: CRF, Naive Bayes and SVM. A knowledge base of court decisions was automatically populated. Finally, the knowledge base was queried to demonstrate how to retrieve similar court decisions. By evaluating the machine learning algorithms that were used, we concluded that they can substantially speed up information extraction from court decisions without compromising quality. The selected features are suitable to represent court decision for the identified purpose.**

## I. INTRODUCTION

Possibilities of applying information technology to tasks previously accomplished only by humans are expanding. That is also true in the case of artificial intelligence and law. One of those problems is retrieving similar criminal decisions.

In common law jurisdictions, such as the UK and USA, judicial decisions are sources of law. Every passed decision becomes part of the law and can be used as a justification for a decision made in a similar case. The same principle is (informally) applied in civil law jurisdictions as well. Judges usually follow the decisions made by higher courts because they do not want their decisions overruled. Therefore, retrieving court decision similar to a given court decision and making analogies with the given court decision is an important task in the legal profession.

This process can be approximated by an artificial intelligence technique called case-based reasoning. Case-based reasoning is a reasoning technique that solves a problem with an unknown solution by revising known solutions to similar problems. It has four steps: retrieve, reuse, revise and retain. Of course, it is not trivial to automate each phase.

This paper focuses on the automation of the first phase of a case-based reasoning process (retrieve) as applied to court decisions. The solution proposed in this paper is a foundation for the development of a system to aid in passing court decisions.

Each case (decision) can be described by a set of carefully selected features. Because court decisions are written in a natural language, those features need to be extracted from the plain text. Manual execution of this task, due to the number of decisions, is not an effective solution. However, automatic feature extraction for plain text is a problem that requires advanced natural language processing techniques.

The rest of the paper is organized as follows. Section 2 gives an overview of the related work. The method, ranging from document acquisition to document querying, is presented in Section 3. Results are presented in Section 4. Finally, we conclude the paper and give an outline of topics for future work in Section 5.

## II. RELATED WORK

Ref. [1] presents a mixed approach that uses linguistic information and machine learning applied to the problem of information extraction from legal documents.

A set of legal documents from the EUR-Lex portal containing acts in English, German, Italian and Portuguese language was used. Bag-of-Words and Term Frequency – Inverse Document Frequency (TF-IDF) were used for determining weights of words in documents and support vector machines (SVM) were used for document classification. Cross-validation on EUR-Lex documents was used for model evaluation. The precision of the classification model was over 95%. Latin languages had the worst results, which is in line with previous research and was probably caused by more complex syntactic structures within that group of languages. Named entities, such as places, organizations, dates, and references were identified using information acquired by natural language parsers.

After comparing results between different languages it was concluded that results for English and German languages were the best and very similar, while results for the Portuguese language were the worst. NER had very good results in extracting dates, average results in extracting locations (10-20% median error rate) and bad results for extraction of organizations and references.

In [2] the authors analyzed problems which occurred during the implementation of the legal expert system JAES. Authors analyzed three solutions: CBR, blackboard architectures and service-oriented architectures (SOA) as a new generation of legal expert systems and are in favor

of using a hybrid architecture to solve the problems of complexity and change present within the legal domain.

JAES was developed to speed up the process of making rules about the transfer of property and risk. The problems discovered during this projects were: complexity, uncertainty and change. JAES presented a solution for one specific and narrow problem, while in the legal domain problems usually cannot be isolated in such way. Also, passing of laws based on existing facts cannot be always determined with 100% accuracy. Finally, laws are not always static and every system has to take into account the alteration of laws)

The authors think that the approach of CBR in the domain of law would be a better solution. Firstly, because the system itself could evolve as the law is evolving. The legal domain represents an excellent field for testing a CBR system, and by its nature, CBR imposes itself as a potential mechanism for automation of enactment of some judicial decisions.

Ref. [3] introduces a formal model of court decisions in Web Ontology Language (OWL) that represents the judge's interpretations while conducting a discourse towards an adjudication.

The main goal is to design an ontology framework capable of detecting and modeling jurisprudence directly from the text and performing some basic reasoning on the resulting ontologies.

It has been concluded that the given ontology represents an innovating approach of managing case law, filling the gap between text, metadata, ontologies and modeling rules, to deepen information obtained within the text, utilizing argumentation theory. OWL2 is used to bring the ontology as close as possible to the rules, to exploit the computational characteristics of description logic.

### III. METHODOLOGY

The method presented in this paper has several steps: document collection, feature selection, feature extraction, and document querying. Each step is described in this section. It is worth noting that the whole solution was developed in the Python programming language. The source code and datasets can be found on the GitHub repository [4].

Firstly, it is necessary to find a collection of court decisions suitable for the problem. We have chosen a collection of decisions published on the web portal of the Montenegrin courts [5]. Because the site does not offer programmable access to documents, a scraper was written using the Selenium library [6]. Nearly 150,000 decisions were retrieved, including first instance criminal court decisions which are the focus of this paper. Decisions were scraped in the HTML format. Python libraries `html2text` [7], `markdown` [8], and `BeautifulSoup4` [9] were used to transform HTML documents into plain text. Their metadata were stored separately as JSON documents.

Secondly, several features were selected as the features that are most suitable for representing court decisions: the judge, the council president, the council

members, the references to the provisions that defines the crime committed, the references to the provisions that define the sanction, and the type of decision. The type of decision refers to whether the offender was convicted, whether he or she received a conditional sentence, whether he or she was released of all charges or whether the case was dropped. Those features were selected based on the review of legal literature and ontologies described next.

We developed an OWL2 ontology by expanding JUDO [3] and LKIF-Core [10] ontologies. The `Judging_Contracts_Domain` ontology was introduced from JUDO ontology and the `Role` ontology was introduced from LKIF-Core ontology. After introducing the given ontologies, unnecessary classes and object properties were omitted, together with all of their existing individuals. Finally, `Judgement` class from the `Judging_Contracts_Domain` ontology was expanded with a couple of important data properties. Modeling was done using the Protégé 5.5.0 [11] ontology editor, with the use of Hermit 1.3.8 reasoner for consistency checking.

Thirdly, text mining and natural language processing (NLP) techniques were used to extract features from court decisions (more specifically, named entity recognition and text classification). The type of decision was extracted using text classification and other attributes were extracted as named entities.

Conditional random fields (CRF) were used for NER. (more specifically, C++ implementation called CRF++ [12]).

A plain text file in a special format is used as a training set and a test set. It is also necessary to create a template file specifying which columns (features) of CRF++ input files will be considered for training CRF++. The features selected were: context window of size 5, if the current token is a title and whether the token contains a digit. Window of size 5 refers to 5 tokens before and 5 tokens after the current token. Token is a title if it starts with an uppercase letter and the rest of the token are lowercase letters.

A sentence splitter and tokenizer for the Serbo-Croatian language was used [13, 14, 15, 16, 17, 18] for sentence splitting and tokenization. The BI (B-beginning, I-inside) encoding scheme was used to represent named entities. Using this scheme it is possible to clearly define which is the beginning token of each named entity, as opposed to the I scheme where it can only be specified whether a token belongs to a named entity chunk or not. In that case, if two different entities are written next to each other, it is not possible to adequately separate them.

It was necessary to manually annotate named entities before creating the training file for CRF++. The Multi-Document Annotation Environment (MAE) [19] annotation software was used for this task because it contains an intuitive user interface. This makes annotation task easy, by highlighting a part of the text and giving it an appropriate label.

The training set contains 1,500 annotated court decision and more than 6 million lines. The test set contains 122 annotated court decisions. The huge file size

always resulted in the crashing of CRF++. For that reason, the text of each court decision was pruned beginning with the “Rationale” section of the decision. This reduced the length of the training set file to approximately 1 million lines and made training possible.

Naive Bayes and SVM were used for classification.

To classify court decisions by their type, the dataset was divided into the training set made up of 1,764 court decisions and the test set made up of 122 court decisions. This is the same dataset used for NER, the only difference being that 264 court decision was added to balance out the number of instances of different classes.

Before training the model, the text of the court decisions was preprocessed. Firstly, it was converted to lowercase to avoid case sensitivity. Then, it was tokenized with a tokenizer for the Serbo-Croatian language. Finally, stop words were removed from the text.

TF-IDF was used to convert the text into a vector consisting of term frequencies before applying Naive Bayes and SVM algorithms for classification.

Fourthly, the developed ontology was used to form a knowledge base of court decisions. The features extracted from plain texts judicial decisions were used for instantiating the created ontology.

Instantiation of the individuals was carried out with the help of the Owlready2 [20] Python library. This library enables handling of ontologies and their elements, reasoning over ontologies (relying on Hermit) and executing SPARQL queries (relying on rdflib [21, 22] Python library).

The following classes were instantiated: Judgment, Jurisdiction, Person, Legal\_Role, Legal\_Rule, and Judicial\_Outcome. Judgment and Jurisdiction classes were instantiated using harvested metadata. Person, Legal\_Role, and Legal\_Rule classes were instantiated using named entities. Judicial\_Outcome class was instantiated using the results of the court case type classifier.

After instantiation of all the individuals, the Hermit reasoner was run and the ontology was saved in a file. Thus, the knowledge base of judicial decisions was formed.

Finally, we wrote a script that dynamically creates SPARQL queries using the features of a new non-instantiated court decision, executes them and prints out the results into a file. Those queries enable retrieval of court decisions from the knowledge base if they match the specified parameters. Hence, it implements the retrieval phase of the CBR cycle.

#### IV. RESULTS

It is possible to numerically evaluate NER and classification tasks. Precision, recall and the F1 measures were used as evaluation metrics for NER. The overview of the results of CRF++ for NER is shown in Tab. 1.

TABLE 1. CRF++ EVALUATION

Class	Precision [%]	Recall [%]	F1 [%]
<i>Judge</i>	99.19	100.00	99.60
<i>Council president</i>	100.00	50.00	66.67
<i>Council member</i>	100.00	75.00	85.71
<i>Crime</i>	94.07	93.82	93.94
<i>Sanction</i>	91.62	94.25	92.92
<i>All</i>	93.83	94.71	94.27

Accuracy was used as an evaluation metric for classification. The accuracy of the classification using the Naive Bayes algorithm is 93.44% and the accuracy of the classification using the SVM algorithm is 97.54%.

Several SPARQL queries were executed to demonstrate how to retrieve similar court decisions. No errors were detected in constructing the SPARQL queries.

An example of a SPARQL query is shown in List. 1. It retrieves identifiers and attributes of court decision of a particular type.

```
SELECT ?judgement ?judgement_type
?judgement_department
?judgement_date
WHERE {
    ?judgement judo_core:applies
mngj:verdict .
?judgement mngj:judgement_date
?judgement_date .
    ?judgement mngj:judgement_type
?judgement_type .
    ?judgement
mngj:judgement_department
?judgement_department .
}
```

LISTING 1. A SPARQL QUERY.

#### V. CONCLUSION

In this paper, we present a solution for finding similar court decisions. A court decisions collection was obtained by scraping the web. Several machine learning algorithms were used to extract selected features from decisions in the plain text format. Those features were selected by analyzing legal literature and JUDO and LKIF-Core ontologies. The extended ontologies were used as a schema to store a representation of court decisions in the knowledge base.

The NER and classification models show that relevant information can be extracted from plain text decisions by using simple machine learning algorithms. An even better accuracy could be achieved by using additional tools in the NLP pipeline. For example, lemmatization can be used to reduce tokens to their base form. That way, the accuracy of the Naive Bayes, SVM, and CRF models could be increased.

Classification of decisions according to its type was limited to four classes (acquittal, conditional, rejected and verdict). Other classes were left out due to an insufficient

number of instances. Moreover, multi-label classification of decisions was not covered in this paper due to having a limited number of decisions labeled with multiple classes. These problems could be overcome by expanding the dataset.

Finally, only a limited number of features was used in this paper. Expanding the feature set with new features, and extracting those features from court decisions, could lead to better results. For example, the feature set could be expanded with features related to the suspect (underage, adult, married, etc.), attributes about the event described in the court decision (e.g. injuries, etc.), as well as the type of the sanction (e.g. fine, prison, etc.).

#### REFERENCES

- [1] P. Quaresma and T. Gonçalves, "Using linguistic information and machine learning techniques to identify entities from juridical documents," *Semantic Processing of Legal Texts Lecture Notes in Computer Science*, pp. 44–59, 2010.
- [2] C. Stevens, V. Barot, and J. Carter, "The next generation of legal expert systems - New Dawn or False Dawn?," *Research and Development in Intelligent Systems XXVII*, pp. 439–452, 2010.
- [3] M. Ceci and A. Gangemi, "An OWL ontology library representing judicial interpretations," *Semantic Web*, vol. 7, no. 3, pp. 229–253, 2016.
- [4] GitHub repository, <https://github.com/nikola310/Legal-Informatics>
- [5] Sudovi Crne Gore, <http://sudovi.me>
- [6] Jason Huggins. "Selenium", <https://www.seleniumhq.org>, 2004
- [7] Alireza Savand, "html2text", <https://github.com/Alir3z4/html2text>, 2008
- [8] Manfred Stienstra, Yuri takhteyev and Waylan limberg, "Markdown", <https://python-markdown.github.io>, 2007
- [9] Leonard Richardson, "Beautiful Soup 4", <https://www.crummy.com/software/BeautifulSoup>, 2014.
- [10] R. Hoekstra, J. Breuker, M. Di Bello, and A. Boer, (2009). "LKIF Core: Principled ontology development for the legal domain," *Frontiers in Artificial Intelligence and Applications*, vol. 188, pp. 21-52, 2009.
- [10] R. Hoekstra, J. Breuker, M. Di Bello, and A. Boer, (2009). "LKIF Core: Principled ontology development for the legal domain," *Frontiers in Artificial Intelligence and Applications*, vol. 188, pp. 21-52, 2009.
- [11] Musen M.A. "The Protégé project: A look back and a look forward," *AI Matters*. Association of Computing Machinery Specific Interest Group in Artificial Intelligence, vol. 1, no. 4, pp. 4–12, 2015.
- [12] Taku Kudo, "CRF++: Yet another CRF toolkit", <https://taku910.github.io/crfpp>, 2005
- [13] Ljubesic, Nikola, Tomaz Erjavec and Darja Fiser. "Corpus-based diacritic restoration for South Slavic languages." *LREC* (2016).
- [14] Ljubesic, Nikola and Tomaz Erjavec. "Corpus vs. lexicon supervision in morphosyntactic tagging: The case of Slovene." *LREC* (2016).
- [15] Ljubesic, Nikola, Filip Klubicka, Zeljko Agic and Ivo-Pavao Jazbec. "New inflectional lexicons and training corpora for improved morphosyntactic annotation of Croatian and Serbian." *LREC* (2016).
- [16] Agic, Zeljko and Nikola Ljubesic. "Universal dependencies for Croatian (that work for Serbian, too)." *BSNLP@RANLP* (2015).
- [17] Fišer, D., Ljubešić, N. & Erjavec, T. "Lang resources & evaluation" (2018). <https://doi.org/10.1007/s10579-018-9425-z>
- [18] Ljubešić, N., "The ReLDI web services library", <https://github.com/clarinsi/reldi-lib>, 2016
- [19] Kyeongmin Rim, "MAE2: Portable annotation tool for general natural language use". In *Proceedings of the 12th Joint ACL-ISO Workshop on Interoperable Semantic Annotation*, Portorož, Slovenia, May 28, 2016.
- [20] Lamy JB, "Owlready: Ontology-oriented programming in Python with automatic classification and high level constructs for biomedical ontologies," *Artificial Intelligence In Medicine* vol. 80, pp. 11-28, 2017
- [21] Carl Boettiger, "rdflib: A high level wrapper around the redland package for common RDF applications," *Zenodo*. <https://doi.org/10.5281/zenodo.1098478>, 2018
- [22] Jones M, Slaughter P, Ooms J, Boettiger C, Chamberlain S, "redland: RDF library bindings in R," <https://github.com/ropensci/redlandbindings/tree/master/R/redland>, 2018

# Graphic Processing Unit Parallelization of the Traveling Salesman Problem Solution

F. Đorđević\*, A. Kupusinac\*\* and D. Ivetić\*\*

\* Faculty of Technical Sciences, Department of Power Electronic and Telecommunication Engineering, Novi Sad, Serbia

\*\* Faculty of Technical Sciences, Department of Computing and Control Engineering, Novi Sad, Serbia  
filip.djordjevic@uns.ac.rs, sasak@uns.ac.rs, ivetic@uns.ac.rs

**Abstract** – We use the OpenCL standard in order to parallelize the Ant Colony Optimization (ACO) algorithm to solve the Traveling Salesman Problem (TSP) and execute the parallelized solution on the Graphic Processing Unit (GPU). For this particular implementation, we found that it, on average, executes 33.3x faster than its sequential counterpart, with the best gain of 59x faster execution for the case of 100 cities and 100 ants.

## I. INTRODUCTION

Travelling Salesman Problem (TSP) needs to be solved in a way that the travelling Salesman needs to visit all cities from a list, where the distances between all the cities are known and every city has to be visited only once.

In the 1800s, TSP was mathematically formulated by Irish mathematician, William Rowan Hamilton and British mathematician Thomas Kirkman.

One way to model this problem is as an undirected weighed graph, where the nodes represent the cities, edges represent paths between the cities, and the distance between two cities matches the weight of the edge.

Frequently, TSP is modelled as a complete graph (each pair of nodes is connected by an edge). It is possible to add an arbitrary edge in order to complete the graph if any edges are missing. This process won't affect the optimal graph tour.

TSP can also be divided into symmetric and asymmetric. In symmetric TSP, distance between two cities is the same in every direction, and the graph is undirected. With symmetry set of possible solutions is halved. With asymmetric TSP, either an edge does not exist or edge weights are different, which creates a directed graph.

### A. Ant-Colony Optimization

Ant-Colony Optimization (ACO) represents an artificial intelligence algorithm which is based on ant behavior when they release pheromones. First use of this in TSP solving was introduced by Marco Dorigo in 1993 [1]. First detailed description of the algorithm was a part of the paper from 1996, [2].

This solution is a part of a group of algorithms that use populations, where the algorithm doesn't always start

from a single node/city, but more “participants” (in this case, ants) start the search for solutions, mostly independent from each other. Depending on the quantity of pheromone that has been laid on the path, ants will move along the path with the most pheromone. As pheromone evaporates, only the best path will remain covered in pheromones (Figure 1).

While following the algorithm, every ant will solve sub-problems and build a solution out of them. Every partial solution is labeled with pheromone level. Bigger the level, bigger will be the chance that an ant will choose that particular solution. Steps of the algorithm are as such:

1. Solve the problem for a number of ants

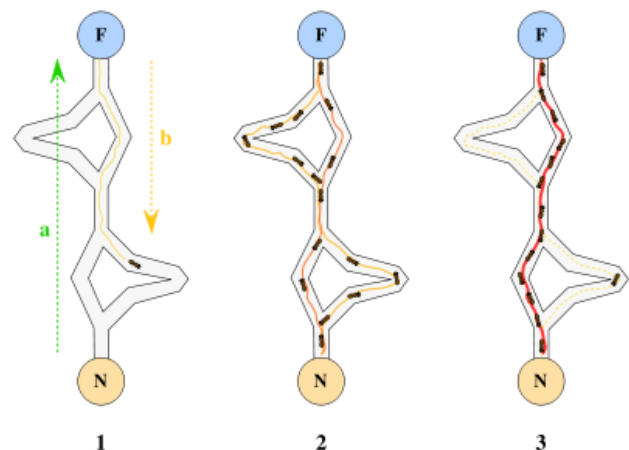

Figure 1. Movement of ants when searching for the shortest path and laying down pheromones

2. Update pheromones
3. If conditions for completing the algorithm are not met, return to step 1.

Since ACO is a *metaheuristic*, there doesn't exist a clear method to check how good is the final solution, which complicates forming the conditions for completing the algorithm. Even so, metaheuristics have one advantage, which is that they don't take the first best solution as final [3].

### B. Graphic Processing Unit Parallelization

In order to utilize the Graphic Processing Unit (GPU) for its superior computing power when attempting to parallelize the implementation of ACO algorithm, OpenCL standard was used.

It represents an open, royalty-free standard for cross-platform, parallel programming of diverse processors found in personal computers, servers, mobile devices and embedded platforms, and it includes a language, Application Programming Interface (API) and a runtime to support software development [4].

The *kernel* method that will be executed in parallel is defined as OpenCL source code that follows the Open CL rules. In a C# application, it is defined as a *string*, which will be compiled by the Open CL compiler.

There are two main identifiers in OpenCL code: “*\_kernel*” and “*\_global*”. The first one tells OpenCL that we will call this function through the API, and the second that parameters with that type need to be accessed from the device memory. The “*get\_global\_id(0)*” is an OpenCL built-in function that returns which thread (worker) is executing the code.

In order to initialize and set up OpenCL Platforms and Devices, *InitCL* method was used. *Compile* method of the *Program* Class will compile the source code string that was passed as the parameter. *Kernel* method of the same Class provides access to this method to the host code. Variables are defined by using the *Variable* type from the *Program* Class, since the device needs to have the data in its own memory. All the variables that are needed for the OpenCL code to execute are stored in an array that is passed to the *Kernel* object through its *Execute* method. Another parameter that is needed here is to define how many threads (workers) need to be invoked.

In order to retrieve any data that was modified in device memory, *ReadFromDeviceTo* method is called on the variable object, and this method encapsulates OpenCL API *clEnqueueReadBuffer* function.

### C. Related Work

In regards to GPU parallelized implementation of the ACO algorithm, one of the first was presented in [7]. In it, Catala, Jaen and Mocholi presented a solution without using advanced toolkits, which then didn't exist in such a capacity as they do today. Because of that, their implementation relies upon a GPU interface that uses graphics paradigms, with an aim to solve several instances of the Orienteering Problem. Their experiments took them to 45% faster solution.

Use of nVidia's CUDA Toolkit, and one new optimization factor was presented in [6]. Paper's authors, Dawson and Stuart, proposed a new way of path construction that also runs in parallel, Double-Spin Roulette. Another thing that they presented was a new implementation of the pheromone update stage with the use of the tiling strategy to cover all edges. All this resulted in an 82x better result of the GPU parallelized implementation as opposed to the sequential counterpart.

Similar ideas of a parallel method based on the I-Roulette were presented in [8], where Uchida, Ito and Nakano achieved gains of around 22x faster execution, and the speedup increased with the size of the problem, with the last one, *pcb3038*, producing a lesser gain.

Ant Colony System and MAX-MIN Ant Colony System are the algorithms that Rafał Skinderowicz took into consideration in [9], where he presented a new way of implementing the pheromone memory, where the pheromone matrix was substituted with a *selective pheromone memory*, with a dynamic selection criterion as to for which edges to store pheromone data. With this he achieved a maximum speedup of 24.29x for the *lin318* instance. But what is interesting here is that even though the *selective pheromone memory* improves the exploitation of the solution search space, it is slower than the pheromone matrix by 30%.

## II. SOLUTION IMPLEMENTATION AND RESULTS

### A. Helper Classes

Since the application is made using the Model View ViewModel (MVVM) Design Pattern and Windows Presentation Foundation (WPF), helper Classes are used to separate the User Interface (UI) logic from Extensible Application Markup Language (XAML) code which is used to define how the application window will look and also Classes that define data models.

Cities will be modelled through the Class *SubstationEntity*, which comprises of an Id number, Substation name, and its position on X and Y axes according to that particular Substation's geographic position, and these values will be used in order to approximate their position. All these Substations are defined in an Extensible Markup Language (XML) file.

Class *XMLHelper* will be used in order to extract the data about all the cities from the XML file by using the method *GetSubstationsDataFromXML*, which will return a list of all *SubstationEntity* objects that were extracted. During that process, all coordinates need to be converted from Universal Transverse Mercator (UTM) format to decimal, and for that, method *ToLatLon* of Class *CoordinateConverter* is used.

Base UI logic is implemented in Classes *RelayCommand*, *EventArgs* and *EventRaiser*. *RelayCommand* implements basic command logic, along with reaction on mouse button press. Classes *EventArgs* and *EventRaiser* are used to as a reaction to the algorithm finding new best solution, which should then be visualized, and to call the methods that will draw the new shortest path.

In order to save the new shortest path, *Pair* Class models a pair of coordinates, which are used in *Tour* Class in order to model the path itself. Methods that *Tour* Class enables define the data source for the list of coordinates for every city and the matrix that saves the distances between all the cities. It is also possible to add a city or a list of cities into a path, and get the list of cities or a particular city from the path. If distance between two

cities is needed or the complete distance of the current path, there are methods to get these values as well.

In order to create a starting path, *CreateRandomTour* method was implemented and it utilizes the Fisher-Yates Shuffle, which will generate a random sequence of cities. The Shuffle itself is implemented in a method of the same name. Shortest path found is stored in the *TourData* Class which consists of a sequence of cities that forms the shortest path, in which iteration of the algorithm was the shortest path found and also the length of the found path.

*CoordinatesMatrix* Class is implemented with the intent that its methods can calculate the distance between the cities in such a way that the calculation is done inside the Euclidean 2D space. Distances are stored in a Dictionary collection, where data is stored in a key-value manner, where the key is a pair of cities coded as a text, and the value is the calculated distance between the cities.

### B. ACO Algorithm

The ACO Algorithm is implemented in the *ACOAlgorithm* Class. Primarily, there are a couple of helper methods which are used to initialize the matrix (*InitMatrix*) according to the data loaded from the XML file and to create the matrix of city distances based on the calculated distances.

When the newest shortest path is found, its coordinates are saved using the *SetTourCoords* method, and for visualization with the method *SetDisplayCoords*. Data needed for the algorithm to execute need to be defined:

- Sequence of cities that every ant will visit.
- Matrix of pheromones with its dimensions equal to number of cities and all values are set to 0.01.
- Matrix of distances between each of the cities

The method that implements the actual algorithm is the *AntColonyOpt* method (Figure 2). First of all, criterion of algorithm completion is set and it is to finish the algorithm if it does not find a shorter path than the current best one in 500 iterations. Every iteration consists of updating the movement of the ants and the layout of pheromones. After updating, paths are checked to see which is the best, and that one is taken as the new path.

Figure 2 shows how the next town in sequence is chosen. Starting node is node 1 and from it the only node that is accessible is node 3. Then, from node 3 there are three possibilities: node 0, node 2 and node 4. First thing to create is an array by the name of "taueta". Elements of this array are calculated with pheromone value of that edge powered to *alpha* value and then multiplied with 1 divided by the distance to the *beta* power.

*Alpha* and *beta* constants are the key elements of the ACO algorithm and empirical evidence showed that the optimal settings of these parameters are for *alpha* to have a value of 1, and for *beta* to have a value of 5 according to [2].

Based on the "taueta" array values, probability to start moving toward a city values are formed and stored in an

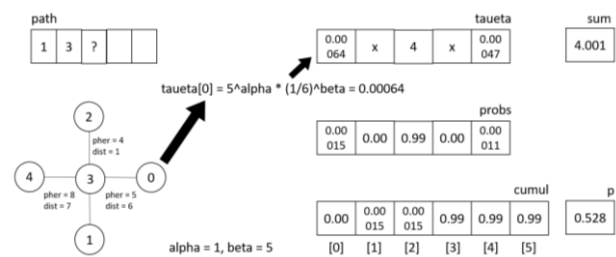

Figure 2. Updating of the ant path

array named "probs". By adding up all the elements of the "taueta" array, "taueta" sum value is formed. Every element of the "taueta" array is then divided by the sum to form the elements of the "probs" array.

Next step is to create an array called "cumul". First element of the "cumul" array is always 0, and the others are cumulatively added up values from the "probs" array. A random number between 0 and 1 is generated next and then it is compared to the values of the "cumul" array. After locating in between which values of the "cumul" array the random number fits (in case of the Figure 2, random number, *p*, is equal to 0.528, and it fits between the cities 2 and 3) so the ant will proceed to the city 2.

What can slow down the algorithm's execution is if the distance between two cities or the pheromone value is too big which decreases the probability. Because of that, in the method *MoveProbs*, where the "taueta" values are calculated, minimal and maximal values are listed.

*UpdatePheromones* method simulates evaporation of pheromones by decreasing its values. This is achieved by using the *rho* parameter of the algorithm. The bigger the parameter *rho*, the bigger will be the pheromone evaporation. The increase of pheromones is achieved based on the distance between the particular two cities and its quotient with the algorithm parameter *Q*. The bigger the parameter *Q*, the bigger will be the quantity of pheromone laid [5].

### C. Application

Main element of MVVM implemented applications is the ViewModel. Its use is to expose the data that will be shown on the UI, and enables the user to access and use the data.

In order to interact with the data, inside of the *MainWindowViewModel* Class Commands have been implemented in order to load the XML file and call for the execution of the algorithm with chosen parameters. When the XML file is loaded, position of the markers of the cities are approximated and drawn on the application window.

After the execution of the algorithm, the *StatusUpdate* method will print out the relevant information about the algorithm's execution – number of the iteration in which the best path was found, the best path's distance and the time that was needed to execute the algorithm.

The application itself was structured with a clear separation of the main menu (Figure 3) that offers the possibility to load a predefined XML file of city positions, and then offers the user the possibility to choose the number of ants that will be used in the algorithm. Also, the user can make a decision which will be the starting node by choosing the sequence of cities that was loaded from the file as the starting sequence or to randomize it



Figure 3. Design of the main menu

using the Fisher-Yates Shuffle.

The other part of the application is the Canvas (Figure 4) in which the cities and the best path between them will

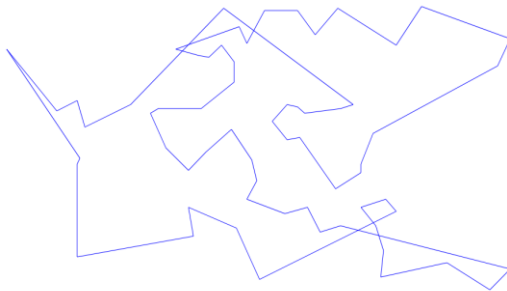

Figure 4. Display of the best path found

be drawn.

Prerequisites for this is that a list of coordinates exists in order to draw the cities and lines between them that symbolizes the best path found.

#### D. Results

In this part of the paper, results of the measurements of the gains achieved by using GPU parallelization are shown.

As it was mentioned before, the algorithm is set up with parameters alpha, beta and rho. Here, their values will be set according to the optimal ones found in [2]. Even so, depending on the set of cities used, they may not be as optimal every time.

The criteria for finishing algorithm's execution (500 iterations need to be done without improvements) adds more time to the overall algorithm execution duration, and because of that the time needed to find the best path is much shorter than the whole algorithm.

The number of cities in the model is used as a list of Substations found in the data of the Power Distribution Entities of Novi Sad. Depending on the number of cities (and ants) per measurement, best path distance and time are different.

Table 1 shows average execution times for different numbers of cities and ants when the algorithm was executing sequentially and when it was executing parallelized. For the sequential execution, 3.3 GHz AMD FX(tm)-6100 Six-Core Processor was used. As for the parallelized solution, it was executed on a 970MHz AMD Radeon R9 380 GPU (GCN 3.0 architecture) with 1792 cores and Memory clock of 1357 MHz.

TABLE I. ALGORITHM EXECUTION TIMES (SECONDS)

	Sequential ACO algorithm	Parallelized ACO algorithm
<b>Number of Ants and Cities: 40</b>	Time: 533.57 (8.8 min) Distance: 2089 (Found in 162 <sup>nd</sup> iteration)	Time: 19.2 (27.8x)
<b>Number of Ants and Cities: 67</b>	Time: 842.6 (14 min) Distance: 3830 (Found in 80 <sup>th</sup> iteration)	Time: 30.4 (27.7x)
<b>Number of Ants and Cities: 85</b>	Time: 9718.2 (162 min) Distance: 4979 (Found in 217 <sup>th</sup> iteration)	Time: 507.1 (19x, 8.5 min)
<b>Number of Ants and Cities: 100</b>	Time: 23738.93 (395 min) Distance: 6188 (Found in 279 <sup>th</sup> iteration)	Time: 397 (59x, 6.6 min)

Implementation demands that every thread (ant) has its own data for the path and probabilities of movement for the purposes of GPU parallelization, according to results stated in [6]. That means that the device has to store a lot more data. This puts more stress on the GPU.

As shown in Table 1, this particular implementation and its parallelization resulted in, on average, 33.3x faster execution. Execution time gains are also shown on Figure 5.

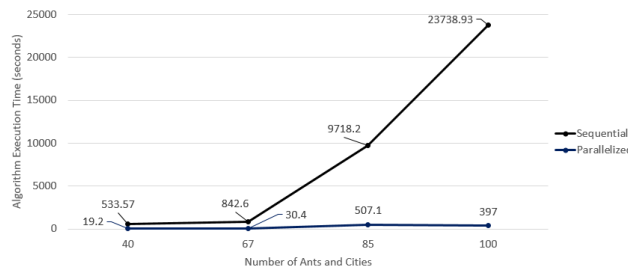

Figure 5. Algorithm execution times

### III. CONCLUSION

Result of this paper is an MVVM implemented application that solves TSP and provides also the solution that is parallelized by using the GPU. For larger number of ants, sequential algorithm's performance degrades a lot, as shown in the example of 100 cities and ants. The solution provided, on average, gets a 33.3x faster execution and keeps the same best path.

Best performance gained was the 59x faster execution of the parallelized algorithm in the case of 100 cities and ants.

Something that can be seen when compared to other papers presented here is that there is a lot of room for improvement of the ACO algorithm in both of its



presented implementations, since other algorithms presented get to performances of 1 millisecond for 198 cities, and the best that this algorithm managed is around 0.02 seconds of execution time for 40 cities (in parallel).

What is encouraging is that with the current implementation improved, the algorithm should achieve similar performance to what other papers presented, and the bad performance for larger data sets of our implementation may be influenced with the fact that the distance is calculated in the Euclidean 2D space, which was the case with other algorithms that had not much performance gained. Another factor could be that the cities' positions are approximated from the real-life data of the Power Distribution System Entities.

Further improvement should also be made with the algorithm's parameters *alpha*, *beta* and *rho*, in order to find the best values that go along with this particular set of cities. Furthermore, the amounts of data used by the CPU and GPU should be reduced in order to maximize the use of the device memory, and achieve better performance.

#### ACKNOWLEDGMENT

This research is financially supported by Ministry of Education, Science, and Technological Development, Republic of Serbia; under the projects number ON174026, III044006 and TR32044 "The development of software tools for business process analysis and improvement", 2011-2019.

#### REFERENCES

- [1] Marco Dorigo. "Ant Colonies for the Traveling Salesman Problem. IRIDIA, Université Libre de Bruxelles. IEEE Transactions on Evolutionary Computation, Vol. 1 (1997), pp. 53-66.
- [2] Dorigo, M., Maniezzo, V., and Coloni, A., The Ant System: Optimization by a colony of cooperating agents. IEEE Transactions on Systems, Man, and Cybernetics Part B: Cybernetics, Vol. 26, No. 1. (1996), pp. 29-41.
- [3] [activevb.de/tutorials/tut\\_antalgo/tut\\_antalgo.html](http://activevb.de/tutorials/tut_antalgo/tut_antalgo.html), Paul Theodor Pyl, Konrad LM Rudolph, Description of the ACO algorithm and its use in optimization.
- [4] The OpenCL Specification, Khronos OpenCL Working Group, Version V2.2-11, 2019.
- [5] [msdn.microsoft.com/en-us/magazine/hh781027.aspx](http://msdn.microsoft.com/en-us/magazine/hh781027.aspx), James McCaffrey, proposition and description of the ACO algorithm implementation in .NET framework
- [6] Dawson, Laurence & Stewart, Iain, "Improving Ant Colony Optimization performance on the GPU using CUDA." 2013 IEEE Congress on Evolutionary Computation, CEC 2013.
- [7] A. Catala, J. Jaen, and J.A.Mocholi, "Strategies for accelerating ant colony optimization algorithms on graphical processing units," in IEEE Congress on Evolutionary Computation (CEC), Sept. 2007, pp. 492-500.
- [8] Akihiro Uchida, Yasuaki Ito, and Koji Nakano, "Accelerating ant colony optimisation for the travelling salesman problem on the gpu", International Journal of Parallel, Emergent and Distributed Systems, 29(4):401-420, 2014
- [9] Skinderowicz, Rafał, "The GPU-based parallel Ant Colony System", Journal of Parallel and Distributed Computing, 2016.

# An Application for the Automatization of the Work Review Process

A. Vasiljević\*, S. Popov\*

\* University of Novi Sad, Faculty of Technical Sciences, Novi Sad, Serbia  
alexva02@uns.ac.rs, srdjanpopov@uns.ac.rs

**Abstract** – Each year, the number of students' work that need to be reviewed grows, resulting in the increase of time required to review them. The time and effort required to review a paper increases exponentially with the number of students, and the likelihood of errors occur. A potential solution to this problem could be a web application to automate the work review process, which would help speed up and simplify the process. The paper analyzes the process of the automating part of work related to extracting archives, taking only directories of interest for further processing of reviewed papers, as well as creating an Excel spreadsheet with student data (name, surname, student unique number) and scoring criteria. The Laravel framework, based on PHP, was used to create the application. The visuals are implemented with reliance on HTML, CSS and JavaScript.

**Key words** – Automation, Laravel, PHP, Excel, MySQL, HTML, CSS, JavaScript

## I. INTRODUCTION

Thanks to the constant work on improving existing and developing new programming languages, it is possible to write modern programs that can be used to automate numerous processes. The advantage of the automation process is that it significantly saves time required to perform tasks that are repeated in whole or in part.

Nowadays, there is a need for application development that aims to simplify the implementation of everyday tasks as much as possible. This is one of the reasons why many applications are available on the market that cover almost every sphere of life. The idea is to create the necessary preconditions for the machine to be able to do at least some of the work instead of a human. Reducing the time required to review papers and minimizing scanning errors are just a few of the many reasons why the web application has been developed to automate the process of reviewing papers.

The central place in the paper will be a detailed explanation of the implemented web application, then the Laravel framework used for its development, as well as the PHP programming language in the background.

## II. PHP

PHP is a scripting language, executable on a server, and used to create dynamic websites and interactive web applications. It is open source, has high performance, is compatible with most platforms for data storage, is

portable, fast, supports procedural execution and is object oriented.

Newer versions of PHP make it possible to work with XML data format, as well as easier error detection and debugging. PHP has a supported instruction set, functions, variables, flow control and conditional structures.

The PHP script file is not translated but interpreted. The programming language PHP is suitable for use since it can run on different platforms such as: Windows, Linux, Unix, Mac OS X. It is compatible with most servers in use today, such as Apache and IIS. It can be integrated with many types of databases – MySQL, PostgreSQL, Oracle, Sybase, Informix and Microsoft SQL Server.

An application to automate the work review process was developed in PHP for its speed, simplicity, built-in security mechanisms, efficiency and flexibility.

It is not necessary to develop an application logic layer from scratch – the application of the appropriate PHP framework produces partially generated program code. Blade template was used to implement the visual part of the application.

A future of this template is that, unlike others, it allows the use of pure PHP code within each HTML page. Each Blade template will be compiled and cached as plain PHP code – when the need arises it can be modified.

Among the best known frameworks PHP can work with are: Laravel, CodeIgniter, Symfony, CakePHP, Yii, Zend Framework, Phalcon, FuelPHP, PHPixie and Slim.

## III. LARAVEL

When developing web applications, certain steps are repeated. Rewriting software components every time would take too much time. A better solution would be to create some kind of a template based on which a component will be partially generated, after which it will be upgraded depending on the specific needs of the application. Laravel is a framework that can be used for this purpose. Because it has the components necessary for rapid application development, uses intuitive syntax, has comprehensive documentation, is open source and has high speed and scalability, Laravel's development environment has a wider range of applications than other PHP frameworks.

A feature of Laravel framework is that it speeds up the application development process due to the fact that it has

a number of built tools: Composer, PHP Artisan and Middleware.

The advantages of the Laravel frameworks are: quality documentation (there are numerous sites and forums where you can find answers to various user questions such as Laracast, numerous video tutorials and practical examples are available followed by detailed textual explanations), intuitive syntax and structure transparency (convenient for absolute beginners and does not burden them with unnecessary information), flexibility (any implemented functionality is subject to modifications without disrupting the rest of the application), simple monitoring of flow control (using route tracking scripts), quality logic for testing all parts of the application, parallelization of the implementation process applications (multiple developers can work on its development at the same time). Laravel also has a number of shortcuts, a high level of abstraction and ease of writing recurring pieces of code.

Like other PHP frameworks, Laravel has some disadvantages: in some situations, it may be that the speed of work does not meet existing standards, the development environment is often upgraded resulting in users being forced to constantly upgrade to newer versions, which gives the impression of an unstable environment, it has not yet become widespread – at present the number of users working with it is rather small (but is constantly increasing) and the complexity of some methods.

#### IV. ABOUT APPLICATION

An application for the automatization of the work review process is web application whose role is to assist the person reviewing the papers. It represents the first stage in the process of reviewing papers (separation of papers, creating a spreadsheet of student information and review criteria). In order for a user to be allowed to use the web application, he must first log on the system. If the user first appeared, it is necessary to register on the system by filling in the appropriate form with personal information. After logging in, the user acquires the right to use the said application completely. Figure 1. shows a schema for a *users* table that list registered users for working with the application.

```
16 Schema::create( table: 'users', function (Blueprint $table) {  
17     $table->bigIncrements( column: 'id');  
18     $table->string( column: 'name');  
19     $table->string( column: 'surname');  
20     $table->string( column: 'email');  
21     $table->string( column: 'username');  
22     $table->string( column: 'password');  
23     $table->rememberToken();  
24     $table->timestamps();  
25 });
```

Figure 1. Database schema for the users table

There is a segment on the home page of the application (Figure 2) where the user uploads the corresponding archive by clicking on the appropriate button. This operation is only allowed for archives ending in .tar or .tgz (the extensions mentioned are for the Linux platform). Also, the uploaded archive is expected to have

the appropriate structure in place to ensure the regular continuation of the application. In addition to the mentioned archive, one must also choose one of the offered test types – T12, T34 or PP. For each type of test offered, a different evaluation criteria which will be subsequently used (when creating an Excel spreadsheet) is bound.

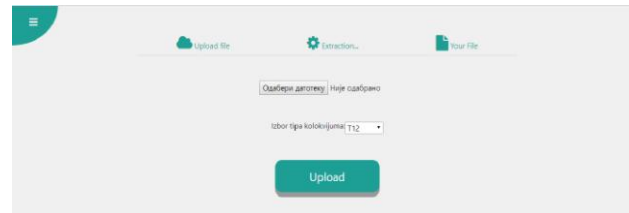

Figure 2. Application homepage

After the upload of the archive has been successfully completed, it proceeds to the next step in which an animation is shown, which represents the percentage performance; ie. how many percent of the uploaded archive was processed (Figure 3). While the animation is displayed to the user, the application attempts to process the archive: in the background, the archive is unpacked according to a pre-specified structure and attention is paid to key directories within the archive. The essential directories are then extracted from the uploaded archive. Information about each student (name, surname and student unique number) is extracted from the directory of interest. When all the necessary data for each student is taken, a special Excel file is created which keeps record of the data of each student whose work will be reviewed.

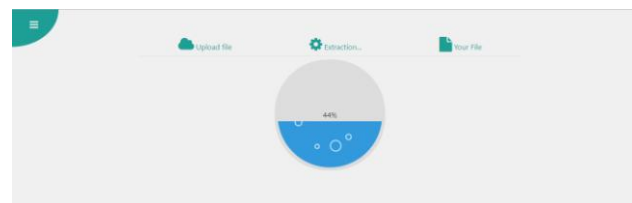

Figure 3. Percentage of processing of uploaded archive

When the animation reaches a percentage value of 100%, it is a signal that the archive has been successfully processed and is allowed to go to the next page. The following page allows the result of executing the application to be downloaded – the resulting archive is downloaded by clicking on the Download button (Figure 4).

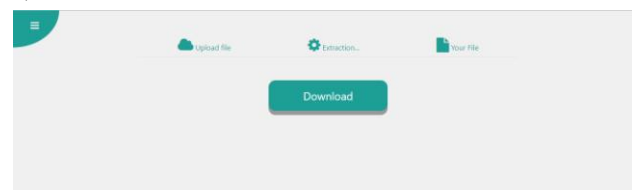

Figure 4. Download page of processed archive

Upon completion of the download, one archive is obtained, which is a concise version of the initial archive. It contains everything that allows for a further process of reviewing to continue. This significantly simplifies the

tiring and repetitive part of the job, avoids potential errors and shortens the entire review process significantly.

## V. IMPLEMENTATION OF THE APPLICATION

The application for automation of the process of reviewing works is intended exclusively for registered users. Figure 5 shows a UML diagram showing the supported functionality.



Figure 5. UML use case diagram

The presentation layer of the application should be as unburdened as possible, which means that the user does not have to bother with superfluous details (eg. uninformative pictures, buttons, animations, text...). The visual appearance of the components should be such as to immediately indicate which of the supported functionalities it refers to. Clean HTML, CSS and JavaScript with the SweetAlert plugin were used to make the appearance of the application. SweetAlert delivers a more visually effective message notification to the user (see Figure 2).

Blade Template was used for a more organized layout of components on HTML pages visible to users. The most significant advantages of using Blade Template are the template inheritance and section mechanisms. The @include directive is used when it is necessary to include another HTML page within an existing one. Another important directive that is often used within this template is @section. It defines the section and its contents. The @yield directive is used to print the contents of the section marked with @section. Other benefits of using Blade Template are time-saving and code-writing simplicity – all Blade programming code is converted to static HTML. Being an application is designed to enable future modifications, Blade Template was a great solution to the visualization problem.

Below the presentation layer is the Laravel framework. Laravel was taken as the basis for developing an application for the automatization of the work process because it works with pre-made components. The structure of the entire project was generated based on the command `composer create-project --prefer-dist laravel/laravel MyApplicationName`. Laravel supports the use of MVC templates. The various components (model, middleware, controller, migration and other) are created based on commands and their binding into the project is

automatic, which means that part of Laravel's work is done by itself.

Laravel has developed numerous Laravel framework plugins that can upgrade basic concepts, creating the necessary prerequisites for its wide usage range across a wide range of domains. To support working with packed archives, it is necessary to install the PharData plugin (Figure 6). The candidate data table and the evaluation criteria are created using the PHPExcel plugin. Saving the resulting table in the desired format is enabled thanks to a special plugin: PHPExcel\_Writer\_Excel2007.

```

39  if ($fileExtension == "tar" || $fileExtension == "tag")
40  {
41
42      $name = explode("/", $fileName[0]);
43      $file1 = $name[1] . "." . $fileExtension;
44      $tar = new PharData(storage_path('app/upload/' . $file1));
45      $tar->extractTo(storage_path('app/extract/'));
46      $subZip = Storage::disk('local')->files('extract'); //uzimaju se ponovo svi fajlovi kako bi
    
```

Figure 6. An example of program code written in Laravel

Web application development also requires the use of a server to monitor the development process. XAMPP platform was used in order to avoid downloading the application after every change to an online server. Laravel's integration with the Apache server is not demanding so this is one of the reasons why the server mentioned above was used. Combining the good and bad features of Laravel (structure transparency versus slower response capability) with certain features of XAMPP (portability, a platform that integrates multiple components required for application development and easy installation), satisfactory application performance has been achieved. Figure 7 shows the XAMPP platform that was used when creating the application.

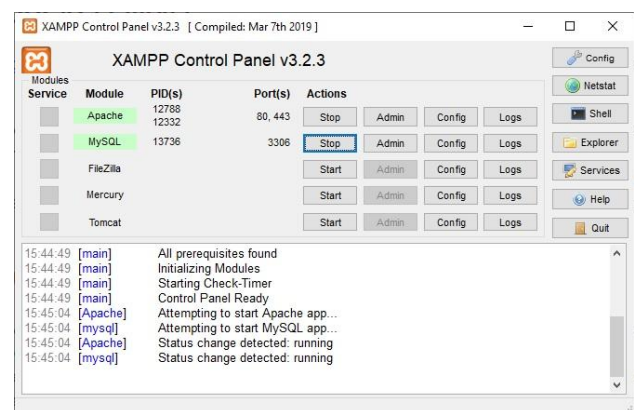

Figure 7. XAMPP platform

This platform needs to be installed on a computer to allow it to be used. Since the XAMPP platform has all the components as a real server, it is possible to transition to the real server without any problems. The platform is running on predefined ports. There were no requirements for any additional adjustments.

The most popular relational database for web application creation is MySQL. Most modern web applications integrate with MySQL, which can be one of the components of the XAMPP platform (Figure 7). A good feature of this database is that it is multiplatform, ie. it is supported by a large number of operating systems.

It's also free to use, and it's also open source, making it customizable.

When developing applications such as an application for the automatization of the work review process, care must be taken that the system must support the existence of different roles. Only the user who has permission to perform „critical“ functionality of the application should have an administrative role ie. anyone who is allowed to enter points in the scoreboard and may set a new scoring scale. The role of the ordinary user should be given to every user who can only see the final results. In order to establish access control and to grant certain rights, depending on what role the user has in the system, it is necessary to have a database of user credentials. To solve this problem, a MySQL relational database was used. The application is implemented so that it can be expanded by adding new functionality that will be able to perform all or only certain roles. If this happens, it is highly likely that some more data will need to be stored and MySQL database will also be used to store it.

## VI. CONCLUSION

Thanks to the implemented application, the one who inspects the works will no longer waste time on the part of the work that can be automated. Instead of repeating the identical job (unpacking the obtained archives as many times as possible to browse, filling the table header with the data on the scoring criteria for a given test, typing the first name, last name and student unique number from the test into the scoreboard), it is enough to forward to the application a packed archive containing all the assignments (it is expected that the archive contains files with a specific structure in order to extract the necessary data from them). This reduces the time required to review the work, reduces the likelihood of possible errors, and at the same time makes the tedious and repetitive part of the job significantly simplified.

There are many programming languages with which it is possible to develop an application of this or similar purpose: C, C++, C#, Java, Python... However, PHP was chosen to implement the specific software solution. The reasons why PHP was used, as already stated in the paper, are above all simple and intuitive syntax, extensibility with various add-ons and external libraries, compatibility with numerous frameworks and object orientation.

The working framework used to develop the application for the automatization of the work review process is Laravel. Like PHP, Laravel is intuitive to users and does not require too much time to learn.

The developed application allowed only partial automatization of the review process since only the first phase was automated – unpacking the forwarded archive, filling in the table header with the scoring criterion for the selected test and entering the candidate information (name, surname and student unique number). The main disadvantage of the application is that it is expected that candidates have to comply with a certain form when

entering personal information and that the work must be placed in a specific directory in a specified format. Also, there is a limit regarding the type of test (T12, T34 and PP) that can be selected.

A future upgrade of the application could be to introduce an admin module and allow the administrator to create a new type of test and a scoring scale for it, so that ordinary users only have read-only access to the table with the final score. In addition, there is a space for partial automation and the process of reviewing the work itself: automatically going through the candidate's software solution and checking the existence of keywords (eg. the absence of the main function means subtracting the number of points prescribed by the scoring scale in the appropriate test). If the whole process of reviewing assignments could be automated, the logic used to solve this particular problem could be used to solve problems of a similar nature.

## REFERENCES

- [1] S. Prettyman, „Learn PHP 7“, 2016
- [2] Uses of PHP, <https://www.sitesbay.com/php/php-uses-of-php> , visited: 02.09.2019.
- [3] Laravel - Overview, [https://www.tutorialspoint.com/laravel/laravel\\_overview.htm](https://www.tutorialspoint.com/laravel/laravel_overview.htm), visited: 02.09.2019.
- [4] Blade Template, <https://laravel.com/docs/5.8/blade#introduction> , visited: 02.09.2019.
- [5] M. Balliauw, M. Baker, „PHPEXcel Developer Documentation“, 2016.
- [6] What is XAMPP, <https://www.wpblogx.com/what-is-xampp/> , visited: 03.09.2019.
- [7] L. Welling, L. Thomson, „Priručnik za MySQL“, 2005.

# Implementing Data Structure Visualizer for Teaching Purposes

S. Popov, R. Radišić and O. Anđelovski

University of Novi Sad, Faculty of Technical Sciences, Novi Sad, Serbia  
srdjanpopov@uns.ac.rs, radisic.rade@gmail.com, andjelovskiolja@gmail.com

**Abstract** - Teaching and learning data structures can be very difficult at times. Teacher has to be able to properly explain to someone new to programming and who is most likely learning his first programming language in parallel. Computer memory model understanding of students at that level is vague, and learning mathematical graph theory can be very abstract. However, graphs can be easily drawn and understood intuitively. This is how usually teachers approach explaining data structures to students. This paper gives insight how a data structure visualization tool can be programmed using modern technologies, platform independent, with high availability.

## I. INTRODUCTION

Data structures are, along with the algorithms, fundamental principles of Computer Science. Future software engineers usually learn about these topics at the very beginning of their curriculum.

The student needs to obtain certain mathematical knowledge in order to learn and understand algorithms and data structures. The prerequisites include knowledge from discrete mathematics, with special emphasis on formal logic notation, sets, relations, functions and graph theory [1]. The last aforementioned is fundamental for proper forming of a data structure mental model.

Since mathematical notation can be rather abstract for someone who lacks basic understanding of the area, visualizations can be helpful in learning data structures. Graph theory is the study of mathematical objects known as graphs [2], which can be easily visualized. A graph  $G$  is an ordered pair  $(V(G), E(G))$  consisting of a set  $V(G)$  of *vertices* and a set  $E(G)$ , disjoint from  $V(G)$ , of *edges*, together with an incidence function  $\psi_G$  that associates with each edge of  $G$  an (un)ordered pair of vertices of  $G$  [2]. Depending on the type of relation of vertices pair, the graphs can be undirected and directed. In simpler, more visual explanation, each vertex is indicated by a point, and each edge by a line joining the points representing its ends [2]. Data structures can be visualized as directed graphs, which can aid to a much more intuitive understanding of a data structure definition and its operations.

## II. DATA STRUCTURES THROUGH PROGRAMMING LANGUAGES

### A. Learning First Programming Language

There are multiple approaches considering how programming and data structures should be taught. Top-down approach would be to teach students a high level programming language, such as *Python*, *Java* or *Javascript*. The things that those languages have in common is they tend to hide low level details, which then opens up space for simpler language syntax through using of abstractions. For example, memory management in those languages is usually obtained through the usage of *Garbage Collection*. Consequence for it is that there is no need to manually deallocate memory, therefore, memory management is left to the software rather than programmer. Bottom-up approach would be to use a low level language, with manual memory management, such as *C*. Programmer has to ensure that every allocated memory is properly deallocated after the data is used.

Both approaches have a direct impact on student's understanding of data structures. When learning a higher level language, a student will have an understanding which includes basic usage, but would not have a clear picture of the memory state beneath. On the other hand, if a student learns low level language, he will be forced to use low level mechanisms that, in most cases, almost directly map to the physical memory state. Students will have a deeper understanding of how things work, but also will have to spend more time learning and understanding programming.

### B. Pointers vs. References

In languages such as *Python*, *Java* or *Javascript*, everything is treated like an object [3]. The identifier used for object manipulation is an object *reference* [3]. Objects are stored on the heap, while object references reside on stack. On the other hand, *C* uses pointers for achieving a similar behavior. A pointer is a variable that contains the address of another variable [4]. The difference between pointers and references is that pointer variables store an integer value that corresponds to an address in memory, while reference points to an object and can be used only for obtaining an object to whom is pointing at. To further clarify, the difference between object reference and a pointer is in level of abstraction. References treat every object equally, so, taken on

example of a linked data structure such as a singly linked list, there is no way to distinguish a reference to a node and a reference that points to the next node, which is contained inside the selected node. When using pointers, nodes are distinguished from pointers, so the pointer needs to be dereferenced in order to get the concrete node value. Using pointers gives more clarity about how the memory is used when storing data.

### C. Data Structure Language Abstractions

In higher level languages, there are usually implementations of data structures included in the standard library. For statically typed languages such as *Java*, the generalization is obtained through the mechanism of generics. That results with a single implementation of a data structure for different data types. Dynamically typed languages go even further, and allow different data types to reside in the same collection. In *C* language, it is possible to write code that will imitate both of the aforementioned behaviors. However, in practice, the code for a certain data structure is written for the explicitly defined types. That lowers the reusability of such code.

Standard library functions cover possible operations over data structures. They can be used by programmers, without knowing the specifics of the implementation. While it positively affects the code reusability and use simplicity, it is bad from an educational perspective, since it leads the student to conclusion that dismisses the importance of knowing the details of an implementation. In a professional career of future software engineer, there will be an algorithm and data structures involved in designing complex systems. Without an insight of a data structure pros and cons, the software engineer will not have enough knowledge to pursue an optimal solution for the given problem.

The differences in approach for learning programming directly influence the level of data structures understanding. Current state leads to the conclusion that neither way of learning is good enough. Focusing on higher level languages will result in poor understanding of the data structures, while lower languages tend to be cumbersome and hard to learn for inexperienced programmer. In order to supplement learning, Data Structure Visualizer tool is being developed by the authors.

### III. DATA STRUCTURE VISUALIZER TOOL

Data Structure Visualizer is a tool that can be used as a teaching aid for faster and better learning of data structures. It consists of two interfaces:

- “Student interface”, a graphical, interactive interface
- “Teacher interface”, textual domain specific language (*DSL*) used for a data structure definition

Student interface is used as an interactive canvas for the data structure manipulation. The student can choose

to try out working between multiple data structures. The concrete data structure view consists of a canvas where the data structure state graph is rendered and panel with available operations. For example, the *stack* data structure has available operations *push* and *pop*. Operation panel will consist of an input value, push and pop button. When there is an input value, pressing the push button will insert new node at the end of a graph. On the other hand, pressing pop button will remove last node from the graph.

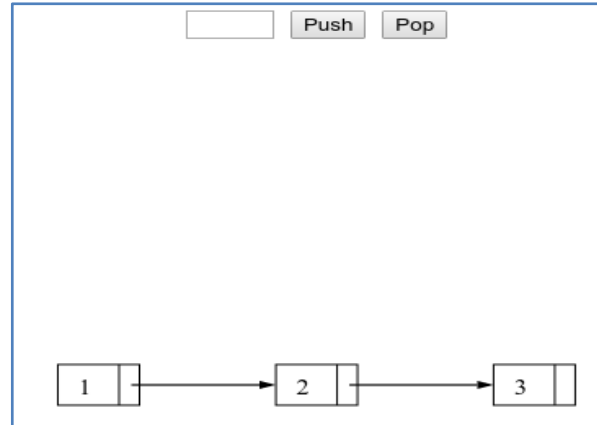

Figure 1. Data Structure Visualizer example

Teacher interface is, in fact, where the data structures which student view uses are defined. Teacher has at his disposal all of the necessary operations (algorithms) to build any data structure. There are two groups of operations, for linear and non-linear data structures. Dependent on the type of the data structure chosen, there will be certain group of operations enabled. Teacher gets to choose needed operation for their data structure.

As a another layer of flexibility, teacher gets to define operation names. For example, the *deque* Wikipedia page has a section where the operations are explained, and operations names differed from programming language to programming language. Apart from being a radical example, it illustrates a problem where in Computer Science there are multiple names for fundamentals, because some of the algorithms were developed simultaneously, in multiple places at once. This feature was added, because it gives a possibility for data structure examples to match curriculum materials terminology wise. For example, to define stack data structure using linked list implementation, there has to be a configuration file present with next lines:

```
datastructure!
{
    name "Stack"
    type "linear"
    implementation "linked"
    operation "Push", push_back
    operation "Pop", pop_back
    operation "Clear", clear
}
```

Figure 2. DSL example of defining stack data structure

This learning tool is meant to be available to use from a web browser, without any installation in “Out of the Box” manner. It was the authors' decision to make it available to the broad public, not just for some students on some faculties.

#### IV. IMPLEMENTATION DETAILS

##### *D. Languages and Technologies*

In order to satisfy the availability requirements, Javascript and Webassembly with Rust were used, for visualization and graph nodes and edges manipulation, respectively.

For graph visualization, a Javascript library *D3.js* is used, as one of the best and proven solutions for data visualization within Javascript ecosystem. *D3* library has the support to render a visualization from a Javascript Object Notation (*JSON*) data input. It also fully supports Scalable Vector Graphics (*SVG*) manipulation, which is supported in all browsers, so the *SVG* elements can be used for displaying components of the graph.

*Rust* [5] programming language is relatively new against its predecessors. It emerged as a system level programming language, but it was widely adopted in many areas, such as web development. Its main strength comes from the fact that it has manual memory management like *C* or *C++*, but it is much more safer, because of the rules and concepts like ownership and borrowing, and their rules built up in language compiler. Unlike most of the modern general-purpose programming languages, it has not garbage collecting mechanisms. These facts give possibility for building a high performance and memory-safe applications.

*WebAssembly* is a binary instruction format for a stack-based virtual machine [6]. It is built up in all major web browsers, but it is not tied to browsers, and can be run standalone. The concept is very similar to the *Java*'s bytecode and *.NET Framework's IL Assembler* [6]. There is textual syntax for *WebAssembly* that reminds of *LISP* programming language, but only the binary format will be executed by the virtual machine. While *JavaScript* is scripted language and will be interpreted in its textual form, which requires all the steps necessary to convert characters to instructions, such as lexing and parsing, *WebAssembly* skips that part because of the binary instruction format. That gives better code performance in most cases against *JavaScript*.

*WebAssembly* is using linear memory, as its memory model. It is a contiguous block of bytes that can be declared internally within the module, exported out of a module or imported from the host [6]. This is the way how *WebAssembly* and *JavaScript* communicate. It is important to note that *WebAssembly* cannot use DOM directly. Linear memory block is shared and host execute some *JavaScript* with the data available through linear memory block. *WebAssembly* does not have heap memory, so the object cannot be allocated using *newoperator* like in some languages. Instead, there are only four primitive types that are used [6]:

WEB ASSEMBLY DATA TYPES

i32	32-Bit Integer
i64	64-Bit Integer
f32	32-Bit Floating-Point Number
f64	64-Bit Floating-Point Number

*WebAssembly* does have its textual format that reminds of *LISP* which can be compiled in binary format that virtual machine can execute, but in most cases it is not how code for *WebAssembly* is written. Usually, higher, general purpose programming language are compiled, and *WebAssembly* binary format is the compiled target. Current situation is that languages whose memory management is not garbage collection are fully supported. Some garbage collected languages like *Go* and *C#* are supported to a certain extent. Also, there is a special dialect of Typescript named *AssemblyScript*, but it also has its limitations. So far, *C/C++* and *Rust* are the most suitable languages for working with *WebAssembly*.

*Rust* has a large palette of tooling available for *WebAssembly*. *wasm-bindgen* is a *Rust* library and command line interface tool that facilitate high-level interactions between *wasm* modules and *JavaScript* [7]. *web-sys* and *js-sys* are libraries that wrap up *JavaScriptDOM* manipulation functions and library functions, respectively.

##### *E. Implementation Specifics*

Graph is modeled as a struct in *Rust* contained of two vectors: one for nodes, one for edges connecting them. Every graph operation is calculated on *Rust* side. After the calculation of the new graph state, it will be converted to *JSON* and put in linear memory. *JavaScript* then reads linear memory and draws graph using previously mentioned *D3* library utilities.

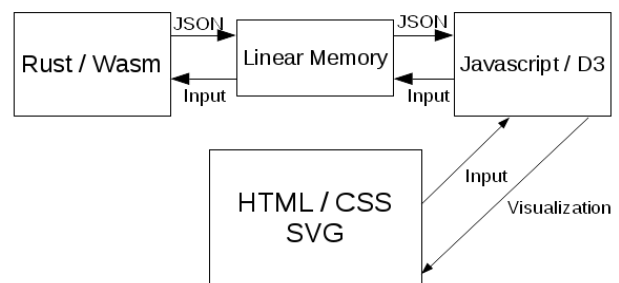

Figure 3. Data Structure Visualizer architecture

As previously mentioned, textual *DSL* is used for defining a data structure visualization. The example given is implemented as *Rust* macro, which will translate into code that is using Builder pattern [8] for defining data structure objects. Example from Figure 2. translates to the next *Rust* code:



```

LinearStructureBuilder::new(
    "Stack".to_string(),
    graph_wrapper
).push_back("Push".to_string()).unwrap()
.pop_back("Pop".to_string()).unwrap()
.build();
    
```

Figure 4. Creating a data structure visualization using Builder pattern

### V. DEMONSTRATION

The usage of the tool will be demonstrated on the example of calculating the expression written in Reverse Polish Notation. The notation which results if operators are placed after operands “a b +” has the property that the operators appear in the order in which they are required for computation [10]. The example expression will be used:

$$3 \ 3 \ * \ 7 \ +$$

Figure 5. Expression example written in Reverse Polish Notation

The Data Structure Visualizer Tool can be used to visualize stack state while calculating the result. First step towards solving the expression from Figure 5 is to push the first two values to the stack:

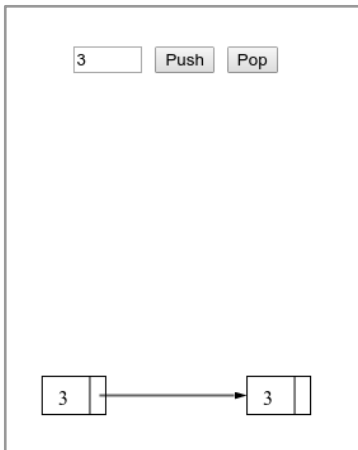

Figure 6. State of the stack after pushing two values

Next token from the expression is the operator “\*”. In case of binary operators, two values are popped from the stack and used as operands to the operation. Resulting value will be pushed back to the stack:

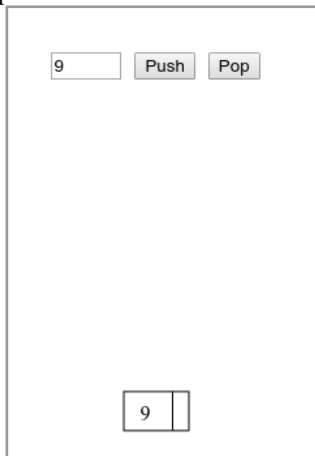

Figure 7. State of the stack after the multiplication of first two values

Since there are only binary operators used in the expression, it requires that at least two values are present on the stack before executing the operation. The next value in the expression is added to the stack:

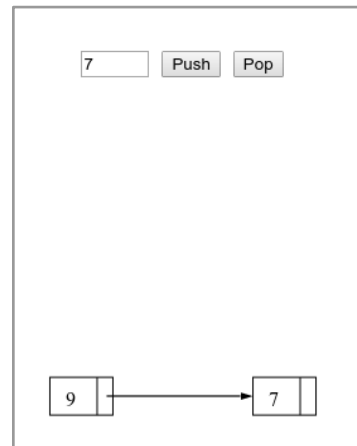

Figure 8. Adding another value to the stack beside previously calculated result

Addition, as the last operand will pop the values from the stack, use them as operands and push the result back to the stack in a similar manner as it was with multiplication. The stack will contain only one value, which is also the result of the expression from Figure 5. Final state of the stack is shown in Figure 9:

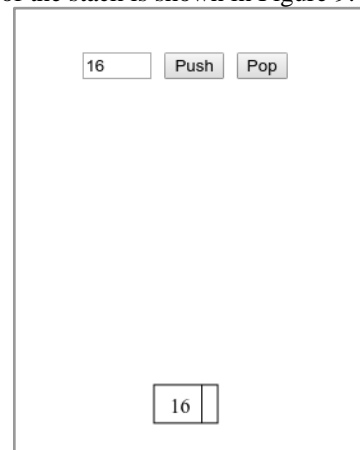

Figure 9. Final result of the expression

The demonstration example is applicable for helping students to visualize every state of the stack when calculating expressions written in Reverse Polish Notation. It should help them to better understand how, for example, calculator logic could be implemented in this particular case.

### VI. CONCLUSION

Visualization is a powerful tool for learning new concepts. Since data structures are by mathematical definition directed graphs and can be visually represented by nodes and edges connecting them, they can be used as a teaching tool explaining abstract concepts beneath. The tool presented is in early stages of development and it is planned to be open sourced as soon as it reaches a stable

version. It is planned to be pluggable into any existing website as a *Node Package Manager (NPM)* dependency. It is a customizable solution, so any teacher can edit it to match data structure terminology which is used to teach the students. Modern technologies such as *WebAssembly* make the solution very flexible and performant, so it could be used in various places, in other words, it's not tightly coupled with platform on which is used. This is suitable for mobile devices, since they can be utilized in such manner. Some researchers find out that mobile devices in education are better than using desktop computers [9]. Hopefully, it will help both teachers and students in their future endeavors.

#### REFERENCES

- [1] Prof. Tom Leighton, Dr. Marten van Dijk "Mathematics for Computer Science", MIT course
- [2] J.A. Bondy, U.S.R. Murty "Graph Theory", 3rd edition, 2008
- [3] Bruce Eckell "Thinking in Java", 4th edition
- [4] D. Richie, B. Kernighan "C Programming Language", 2nd edition
- [5] Steve Klabnik, Carol Nichols "The Rust Programming Language"
- [6] Kevin Hoffman "Programming WebAssembly with Rust"
- [7] "wasm-bindgen guide"
- [8] E. Gamma, R. Helm, R. Johnson, J. Vlissides "Design Patterns Elements of Reusable Object-Oriented Software"
- [9] Y. Sung, K. Chang, T. Liu "The effects of integrating mobile devices with teaching and learning on students' learning performance: A meta-analysis and research synthesis", *Computers and Education*, volume 94, March 2016
- [10] C. L. Hamblin "Translation to and from Polish notation", *The Computer Journal*, Volume 5, Issue 3, November 1962

# Introducing the Ruby Programming Language into Education

O. Anđelovski, R. Radišić and S. Popov

University of Novi Sad, Faculty of Technical Sciences, Novi Sad, Serbia  
andjelovskiolja@gmail.com, radisic.rade@gmail.com, srdjanpopov@uns.ac.rs

**Abstract** - Selecting and introducing a new programming language into education is a great challenge precisely because of the large number of programming languages and their specificity. The paper analyzes the imperative and object-oriented paradigm of the Ruby programming language, as a relatively young, modern language. To analyze the imperative paradigm, we implemented a *Bubble sort* algorithm, in which we did syntax analysis of the Ruby programming language, which would represent the initial course. For the purpose of presenting an advanced course, we performed an object-oriented paradigm analysis and created the *Travel* web application in the Ruby on Rails environment, which is a flexible and very powerful tool for rapid application development. We also analyzed the functional paradigm through examples to outline the basic concepts of the functional paradigm.

**Key words** – Ruby, Object-oriented paradigm, Imperative paradigm, Functional paradigm, Ruby on Rails, Spring, Java, C

## I. INTRODUCTION

The existence of many programming languages gives a wide possibility as well as responsibility in choosing a programming language that will present the basic concepts of programming. In addition to the syntax and semantics that are specific to each programming language, programming paradigms that can be implemented within the programming language play a major role in choosing a programming language.

By choosing a paradigm, students are presented with an approach, that is, methods to solve certain problems and complete tasks. Each paradigm represents a set of concepts and traits to follow in order to successfully implement the program. Paradigms can influence the model of the problem execution, the order of operations, the way code is organized, the style and syntax of programming. Programming involves looking at problems from different domains, in which knowledge of other sciences is often necessary, so the choice of paradigm depends on the nature of the problem being solved.

Below, we will look at the concepts and ways of implementing the imperative and object-oriented paradigm of the Ruby programming language, from the perspective of introducing the Ruby programming language into teaching as one of the relatively young programming languages.

## II. RUBY

Language development was started in 1993 by *Yukihiro Matsumoto* and first published in 1995. With its first release, Ruby has attracted developers around the world, and in 2006 it became widely accepted. Ruby's main implementation has been written in C, and over the years many alternative implementations have been written in various programming languages.

Ruby combines syntax inspired by the *Perl* and *Ada* programming languages, with sophisticated ideas from complex programming languages like *Lisp* and *Smalltalk*. Ruby uses metaprogramming and thus the Ruby program can correct its own code.

It is a general purpose and open source language. What makes it usable is the portability of the source code, flexibility, efficiency, shorter build time, and simple syntax. In Ruby everything is an object. Each information and code can be assigned its own properties and actions. Users are not restricted from using, but have the freedom to add, remove and modify existing parts of Ruby.

The Ruby programming language is characterized by natural syntax. It does not contain unnecessary characters, it is very clear and intuitive, so much that Ruby enjoys popularity in industrial applications such as *SunMicrosystems*, *Intel*, *Microsoft*, *Apple* and others.

Like most programming languages, the Ruby programming language supports multiple programming paradigms, including an *imperative*, *object-oriented* and *functional paradigm*, which leads us to think about introducing the Ruby programming language into teaching and how to do exercises in the classroom.

## III. IMPERATIVE PARADIGM

As an initial programming course, there is a need to use the imperative paradigm as one of the intuitive ways to write programming code. Using an imperative paradigm, commanding, splitting functionality into small, discrete functions, creates the feeling that everything depends on the programmer, which is a good starting point for presenting basic programming concepts.

The code written in the Ruby programming language is quite clean. The readability of the program is increased, and thus the understanding of the code, which is very important for beginners. The basic concepts of the Ruby

programming language that students should be familiar with are: *comments*, *keywords*, *constants*, *variables*, *operators*, and *control structures*, which forms the basis for a more advanced course. The terms listed are enough to implement the first programs, which may interest students and encourage them to study independently. When teaching, especially in courses related to the basics of programming, it is important to bring programming through meaningful examples to students. Often, the already known algorithms for solving a problem are often taken as examples, precisely because of the applications they have found in various branches and the way in which the concepts of programming languages within which they have been implemented can be presented.

During the research we decided to study *Bubble sort* algorithm. One reason for choosing sorting is that the problem of sorting has attracted many researchers at the very beginning of their research in the field of computing. Even though the type of problem is very clear and intuitive, the complexity itself and finding a way to solve it effectively is a great challenge. Many scientists believe that sorting is a fundamental problem in algorithm theory, some of the reasons that point to this fact are:

- *Business applications* -the need to sort information to prepare reports.
- *Computer Graphics* - use sorting as a subroutine to render graphic objects.
- *Sorting speed* - many engineering problems are related to the speed of program execution in a given situation, and therefore there is a need to study in detail the advantages and disadvantages of algorithms, etc.

We implemented Bubble sort algorithm in Ruby programming language and compared with characteristic implementation of algorithm in classic imperative language C. We chose programming language C, because it is mostly used in teaching as the first programming language to be studied.

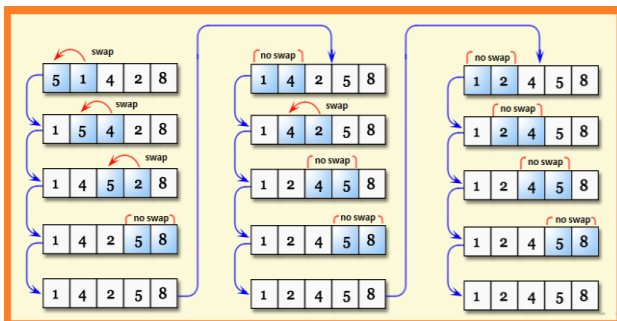

Figure 1. Bubble sort algorithm shown through the steps

```
array = []

File.open("inputFile.txt", "r") do |inputFile|
  inputFile.each_line do |line|
    array << line.to_i
  end
end

swap = true
while swap do
  swap = false
  for i in 0.. array.size-2
    if array[i] > array[i+1]
      array[i], array[i+1] = array[i+1], array[i]
      swap = true
    end
  end
end

File.open("outputFile.txt", "w") { |file| file.write(array) }
```

Figure 2. Sorting array in ascending order in Ruby

```
#include <stdio.h>
#include <stdlib.h>
#include <stdbool.h>
#define elemntNum 10000

int main() {

  int array[elemntNum], i = 0, temp;
  bool swap = true;
  FILE *inputFile;

  inputFile = fopen("inputFile.txt", "r");
  while (fscanf(inputFile, "%d", &array[i])){
    i++;
  }
  fclose(inputFile);

  while (swap){
    swap = false;
    for (i=0; i<elemntNum-1; i++){
      if (array[i] > array[i+1]){
        temp = array[i];
        array[i] = array[i+1];
        array[i+1] = temp;
        swap = true;
      }
    }
  }
  FILE *outputFile;

  outputFile = fopen("outputFile.txt", "w");
  for (i=0; i<elemntNum; i++){
    fprintf(outputFile, "%d\n", array[i]);
  }
  fclose(outputFile);

  return 0;
}
```

Figure 3. Sorting array in ascending order in C

When analyzing code written in the Ruby programming language, we see that iterative and conditional structures are enabled, as well as working with data flow in a manner very similar to programming language C. What we can notice is that when working with files, unlike C in Ruby we do not need to take care of whether the data stream is closed at the end, but the file automatically closes immediately after the operation is completed. By using Ruby syntax, we reduced the need to use auxiliary variables, thus replacing places in the string with only one line of code, without having to store values within a temporary variable like done in C programming language.

Looking at the code written in Ruby, we notice that the syntax is very simple and that the language itself has a large number of functions with built-in checks, which makes it much easier to write code. It is entirely possible to implement an algorithm with an imperative approach, but precisely its flexibility, both syntactic and structural, can be a problem for beginners.

If we look at today's trends in application development, we can see that most attention is paid to web application development. Many students are interested in participating in the entire process that results in the final product. The goal is to teach students the basics of programming, but it is imperative to start as early as possible with the real problems developers and engineers in general face. This is exactly what drives us to think about introducing new programming languages into teaching, and from that point of view, Ruby fully meets the criteria.

#### IV. OBJECT-ORIENTED PARADIGM

Learning object-oriented paradigm is the basis for learning programming in order to develop user applications with a defined user interface and functionalities necessary to perform operations. Object-oriented programming offers many benefits in programming. Object-oriented programming offers many benefits in programming. It deals with organizing code into classes, enables the use of functionality without knowing the specifics of behavior or data within objects, allows defining abstract types where functionality is only partially defined, etc.

The possibility to implement an object-oriented paradigm in the Ruby programming language led us to analyze the basic principles of the object-oriented paradigm and to consider the possibility of introducing Ruby from the aspect of the object-oriented paradigm within the advanced course at the senior years of study.

The basic concepts that should be covered after successfully completing the basic course are: *classes*, *objects*, *constructor*, *destructor*, *modules*, *inheritance*, *polymorphism*, *encapsulation*, *modularity*, *conversion*, *operator switching* and *dynamic linking*.

Analyzing the object-oriented paradigm, we concluded that all concepts of object-oriented paradigm can be fully implemented in the Ruby programming language. Concepts such as abstraction, encapsulation, modularity, polymorphism, operator switching, class connections can be almost completely mapped by looking at *C++* or *Java* as one of the first studied and most popular object-oriented programming languages. In addition to basic concepts, the Ruby programming language offers several mechanisms for implementing more complex concepts, one of which is multiple inheritance, which is prohibited in the Ruby programming language to reduce complexity and ambiguity. The lack of multiple inheritance can be a very negative feature of a programming language, so in Ruby it is possible to implement a *mixin* mechanism. Ruby classes can include the functionality of any number of mixins. This provides a controlled multiple inheritance like capability with none of the drawbacks [1]. Ruby has many features that make it faster and easier for developers to code, some of which are access methods that we can use to access attributes that are outside the class, and many others.

After learning the concepts of the object-oriented paradigm in Ruby, students should be presented with a Ruby on Rails environment for creating web applications.

#### V. RUBY ON RAILS

Ruby on Rails is one of the most popular environments for developing client-server-based web applications written in the Ruby programming language. Rails uses an *MVC (Model-View-Controller)* architecture whose basic idea is to reuse existing code, facilitate code development, and separate the code into separate components. The *Model* represents the entities stored in the database, the *View* should present the interface to the user, while the *Controller* oversees manipulating the model and responding to the user's request. In order to perform a specific task, the user sends a request to the controller that processes the request and manipulates the model, the result representing the modified model is sent from the controller to a view representing a visual representation of the result obtained. The MVC template in Rails enables easier communication between the database, web services and websites.

Ruby on Rails encourages the use of *XML* and *JSON* web standards for data transfer, as well as *HTML*, *CSS*, and *JavaScript* for creating a user interface. Using conventions when creating applications, introducing migrations and many other concepts, Rails has had a great impact on web application development. Ruby on Rails has made a milestone in the look and feel of web application development, which can be leveraged in education to track the development of modern technology.

#### VI. APPLICATION IMPLEMENTATION IN RAILS

We have implemented the *Travel* web application in the Ruby programming language within the Ruby on Rails environment, using concepts of object-oriented paradigm. After that, we did a comparison with an application written in Java using the Spring environment, which is currently the most represented in teaching.

The *Travel* application is a web application whose basic functionality is to view and book accommodations as well as perform basic crud operations over defined entities. The following users have been identified to perform the main functionalities within the application: administrator, agent and customer. Figure 4. shows the data model.

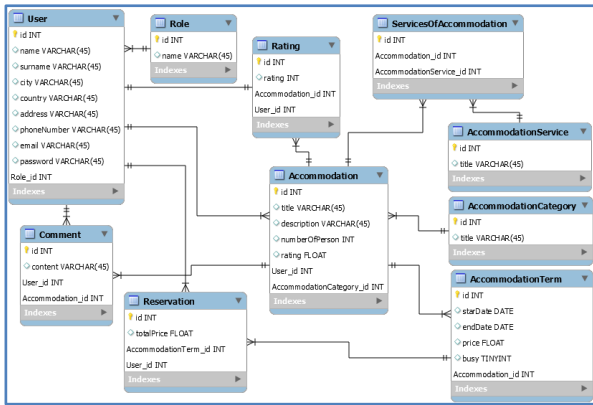

Figure 4. Data model

The basic idea that Ruby on Rails relies on is that if a developer writes applications the same way, performs configuration using the same mechanisms, then it should be the default mode of configuration and thus speed up code writing. Explicit configuration is only used in cases other than the standard convention.

In order to successfully implement the application, it is necessary for the developer to be well versed in the concepts and conventions that Ruby on Rails adheres to. Much of the code is self-generated in one step, and Ruby on Rails takes care of the configuration, so disobeying conventions can make it difficult to create applications.

From the point of view of a developer who is first introduced to the concepts of object-oriented programming, and to whom Ruby on Rails is the first platform for web application development, automatically generating large amounts of code and performing background operations may be a problem. By writing an application using Java and Spring we get the feeling that it depends on us how certain functionality will be executed, we oversee configuration and by initiating commands we initiate certain execution.

Considering the Rails environment from the perspective of a developer who is well versed in concepts, this should not be a problem. In order to quickly deploy business applications that in most cases need to implement the same functionality, Ruby on Rails has a great advantage.

Considering the above facts, we concluded that the advanced Ruby programming language course can be divided into two parts. The first part would refer to the object-paradigm itself, while the second part would relate to web programming. In order to introduce the second part of the course, it is necessary for students to have previously learned *HTML*, *CSS*, *JavaScript*, *JQuery*, *JSON* and *XML* in order to successfully master web programming within the Ruby on Rails environment. Therefore, it is an indispensable study of *C++* and *Java* programming language, after which an advanced Ruby programming language course could be introduced to accompany the development of technologies and new interests in the field of programming.

## VII. FUNCTIONAL PARADIGM

Unlike the imperative and object-oriented paradigm, the functional paradigm avoids state change and variable data. A key concept of a functional paradigm is to derive a series of mathematical functions that represent a central model for abstraction and are intended for a particular computation rather than a data structure. Data is loosely linked to functions, and the function hides their implementation.

The focus of a functional paradigm is on “what to solve” in contrast to an imperative style where the main focus is “how to solve”. The basic concepts that should be covered in the Ruby programming language to represent a functional paradigm are: *blocks*, *proc object*, *lambdas*, *immutability* and *recursion*.

Block it is nameless function in Ruby. It is set as the last argument and only one block can be passed within a function. Ruby block is useful because it allows the programmer to reuse a block of code between the functions.

```
array = [3,5,7,9,11]
array.each { |element| print (element * 3).to_s + " " }

# => 9 15 21 27 33
```

Figure 5. Example of block in Ruby

Proc objects are blocks of code that have been bound to a set of local variables. Once bound, the code may be called in different contexts and still access those variables [2]. It can be passed to a method or another proc object as an argument and can be called. It is essential for Ruby functional programming features concept.

```
fact = Proc.new{|n| n * n }
print fact.call(3)

# => 9
```

Figure 6. Example of proc in Ruby

A lambda is an anonymous function. It is a function definition that doesn't have a name. It is not bound to an identifier. It can be assigned to a variable, but it doesn't have a name by which it can be called. Anonymous functions are often used as arguments for higher-order functions.

```
lambdaFunction = ->(x) { x * 3 }
print lambdaFunction.call(11)

# => 33
```

Figure 7. Example of lambda in Ruby

Immutability is concept in which state of object cannot be modified after it is created. Immutable object has advantages, they are thread-safe, it easier to implement encapsulation, accessor methods can return object without fear that object can be changed, etc. In Ruby we can implement immutability by calling *freeze* method on the instance. In Ruby, the concept of immutability can be

violated by the definition of pure function that doesn't mutate its inputs, so the concept is not fully satisfied.

```
def immutableRemove(array, item)
  array.reject { |i| i == item }
end
array = [9,11,3]
puts immutableRemove(array, 3)
# => [9, 11]
puts array
# => [9, 11, 3]

puts ' '
def mutableRemove(array, item)
  array.reject! { |i| i == item }
end
array = [9,11,3]
puts mutableRemove(array, 3)
# => [9, 11]
puts array
# => [9, 11]
```

Figure 8. Example of immutable and mutable function in Ruby

In Recursion, the solution to each problem depends on solutions to smaller instances of the same problem [4]. Recursion reduce unnecessary calling of function and through recursion one can solve problems in an easy way while its iterative solution is very big and complex or even impossible. Also, recursion keep variables immutable and that help programmers to write better and clean code and much easier to test.

```
def bubbleSort(arr, n)
  if n == 1
    return
  end

  for i in 0..arr.size - 2
    if arr[i] > arr[i+1]
      arr[i], arr[i+1] = arr[i+1], arr[i]
    end
  end

  bubbleSort(arr, n-1)
end

arr = [3, 9, 11, 5, 1]
bubbleSort(arr, 5)

print arr
# => [1, 3, 5, 9, 11]
```

Figure 9. Sorting array recursively in ascending order in Ruby

Using recursion in programming to students is often a problem. Because of the logic behind executing recursive code, as well as the difficulty of debugging recursive code. Following an iterative way of programming through the study of an imperative and object-oriented paradigm, one should study the functional paradigm and encourage students to recursively think in order to expand the way of thinking and master the logic of recursive code.

The advantages of using a functional paradigm are the reduction of errors - due to the absence of side effects, efficient parallel programming - there are no state changes. Every class or method in program should have only a single reason to change [3], so one function can be

treated as instruction, efficiency - the program consists of independent units that are competitively executed, etc.

The effectiveness of program code written with a functional paradigm is directly proportional to algorithmic efficiency and execution speed. Good efficiency allows for greater performance. Nowadays, when there is a large amount of complex data, it is necessary to take advantage of new technologies, which has led us to study the functional paradigm in terms of using the Ruby programming language.

## VIII. CONCLUSION

The Ruby programming language is a modern, first of all, object-oriented language that implements multiple paradigms. In Ruby programming language it is possible to implement algorithms with an imperative approach. It is also possible to implement the concepts of the object-oriented and functional paradigm. It is very flexible, both syntactically and structurally.

By analyzing Ruby from the aspect of basic and advanced level, we conclude that it is possible to write code in several ways and therefore it is possible to conceive in various ways the very concept of introducing Ruby programming language into teaching. The Ruby on Rails environment follows the trends in web application development and as such due to the rapid development of applications, the conventions provided by the environment are popular and represent the Ruby programming language as a good candidate for introduction to teaching.

In the course of the research we have concluded that understanding of Ruby programming language requires knowledge of programming languages such as C, C++, Java, which are also the most represented in teaching. Therefore, it would be desirable to study Ruby programming language at senior years, as an excellent choice for developing web applications that are increasingly the focus of programming.

## REFERENCES

- [1] D. Thomas, C. Fowler, A. Hunt, "Programming Ruby - Pragmatic Programmers Guide", United States of America, 2001.
- [2] <https://ruby-doc.org>
- [3] R. Warburton, "Object-Oriented vs. Functional Programming", United States of America, 2015.
- [4] R. Graham, D. Knuth, O. Patashnik, "Concrete Mathematics", United States of America, 1990.

# Service Order extensions to the Outage Management System

S. Popov and R. Mihić

University of Novi Sad, Faculty of Technical Sciences, Novi Sad, Serbia  
srdjanpopov@uns.ac.rs, relja.mihic@gmail.com

**Abstract - Outage handling is a key business process in a power distribution network. As power distribution grows more complex as the grid is expanded, a software solution is necessary to automate the process.<sup>[1]</sup> The software needs to be appropriated to rules and conditions of such distribution networks. In this study we will be using an existing software solution, developed by an international vendor. Our goal is to expand it based on requirements set by a real electricity distribution company.**

## I. INTRODUCTION

The control system of the grid is the SCADA (Supervisory Control and Data Acquisition), which is a system that works on several levels. In power distribution networks SCADA normally collects statuses (switches, fault indicators, etc.) and measurements (voltages, currents, etc.) from the field and enables operator to send the commands to the field. All collected data is processed and stored. Data and actions are controlled via a User Interface, as part of SCADA software. On the top of the SCADA, a layer of power application suites is commonly running, which can be a Distribution Management System, Transmission Management System, Outage Management System (OMS), etc.<sup>[2]</sup>

The main module which we are concerned with in our project is the Outage module. It contains several outage types: planned, unplanned and fuzzy. Planned and outages are already implemented as part of this system, as are fuzzy outages, which represent events who's exact specifics aren't yet concluded. Our task is the addition of Service Orders into this module.

The task of OMS is to process, control and document outages and planned works on the grid. It contains several modules<sup>[3]</sup>:

1. OMS – SCADA integration – this module provides OMS with a current network topology, potential outages, various electrical data and, in the other direction, providing the various information for SCADA UIs (schematics)
2. Integration with external systems – this module provides data from the external system, in this particular case Service order request
3. Trouble tickets – these are reports and calls made by consumers about potential

outages, and are used to determine the nature and position of the outage

4. Outage processing – the main module which directly corresponds to the outage
5. Web displays – module for presenting the data in tabular fashion and conducting interaction with an operator
6. Burst Management – module used for managing specific events with large scale outages, such as storms.
7. Tasks – an outage specific module, which determines the exact job to be done and connects it with corresponding crews and equipment
8. User Permissions and Areas of Responsibility (AOR) – module made of tree data structures the nodes of which represent regions, areas, municipalities and zones of the grid. These zones are granted to both crews in the field, and users which use the software
9. Crew Management – module responsible for ordering personnel and crews and assigning them to appropriate tasks
10. Equipment – module used to distribute equipment to compatible crews and tasks
11. Archive – module used to keep all data after it's been used for future reference.

Service Orders are specific set of works which are required when a consumer who was previously disconnected from the grid, needs to be reconnected (for example in the case of not paying electrical bills, or long-term absence from a property) or customer have to be disconnected from the network.

A Service Order represents an operation on the system which cannot fall into either the planned nor unplanned category, although many of the mechanisms behind it are analogous.



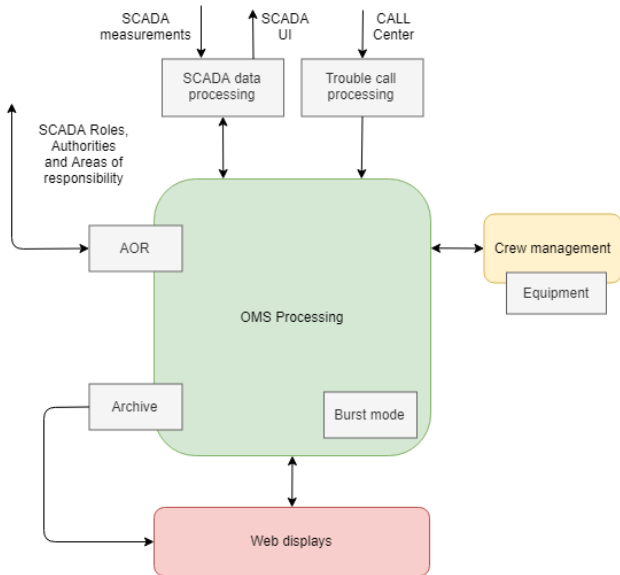

Figure 1. OMS modules

The service order requests can be created by filling out a form, called a trouble ticket. In this case most common way is creation of a Service orders from external customer system. Trouble call received by external system is being sent by WebSphere using Web Services via SOAP (Simple Object Access Protocol) over HTTP application layer protocol. The communication will be synchronous and the acknowledge message will be sent within predefined time.

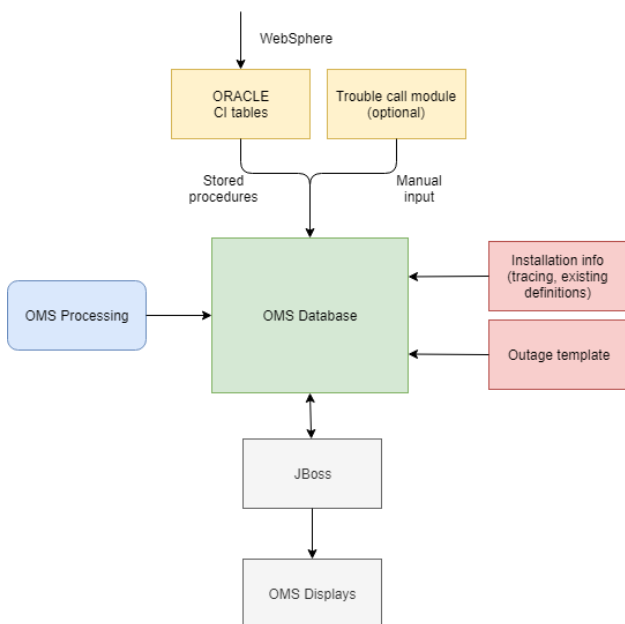

Figure 2. Information flow

Exchanging of the messages, in this case trouble call definitions, is done in compliance with CIM standard. The Common Information Model (CIM) is a standard developed by the electric power industry that has been

officially adopted by the International Electrotechnical Commission (IEC) for power transmission and distribution. The purpose is to allow application software to exchange information about the configuration and status of an electrical network.<sup>[4]</sup>

```

<message name="getTermRequest">
  <part name="term" type="xs:string"/>
</message>

<message name="getTermResponse">
  <part name="value" type="xs:string"/>
</message>

<portType name="glossaryTerms">
  <operation name="getTerm">
    <input message="getTermRequest"/>
    <output message="getTermResponse"/>
  </operation>
</portType>

```

Figure 3: CIM Based Messaging Format

There are two types of Service Orders: “Cut from market” and “Put into service”. They should contain data about the location of the Service Order (such as an Address, Zone, Location, Municipality), details of the consumer who made the order (their First Name and Last Name, Contact Telephone Number, and personal data), comments and notes, as well as technical data about the installation which needs service.

Service Orders can have one of the following states: Open, Approved, Rejected, Canceled, In Progress, Finished and Archived. Once a Service Order has been created, it automatically gains the Open status, after which it is manually switched to Approved or Rejected, based on the software users decision. From Approved, it may only gain the In Progress status after it has been assigned a task and a crew, or gain the Cancelled status if all crews are busy in due time, or no concrete tasks can be established. After the task has been completed, the Service Order gains the Finished status. A finished service order can be sent to the Archive, alongside other finished or Canceled works. If a Service Order was Rejected, it can later only be sent to the archive.

In order to display the data we need a comprehensive UI, consisting of a tab on the main Outages display which has tabs for all other Outage types, and a pop-up window which can be opened from the tab in order to show advanced data and options for a specific Service Order. Our work type needs all the functionalities of other outage types, such as the possibility of focusing one Service Order, creating a formalized task request, assigning a crew to the Service Order, following the time of major events

related to the Service Order, changing the status of the order, possibility of printing the Service Order in a form of a standardized report, and archiving it.

## II. IMPLEMENTATION

Our software spans several servers, and a web client to present the data, as well as many included tools. It uses the Jboss Application Server, which runs in front of an Oracle database, and in behind a web server. The web application is created based on a special framework consisted of several XML schemas, which the framework then interprets as HTML, CSS and JavaScript code. These XMLs can directly call Java methods in run-time, in order to trigger changes to the display, without interacting with the database. This allows for more freedom in interacting with the User, as their input can easily be validated, formalized, charted and logged. After changes to the display produce data which is committed, it gets grouped by and interpreted by Java and JavaScript classes, which send the data to processes running on the server. These processes are responsible mainly for tracing, a.k.a. interpreting the given data as actual elements on a virtual grid, and in the context of said grid, sending them to the Database.

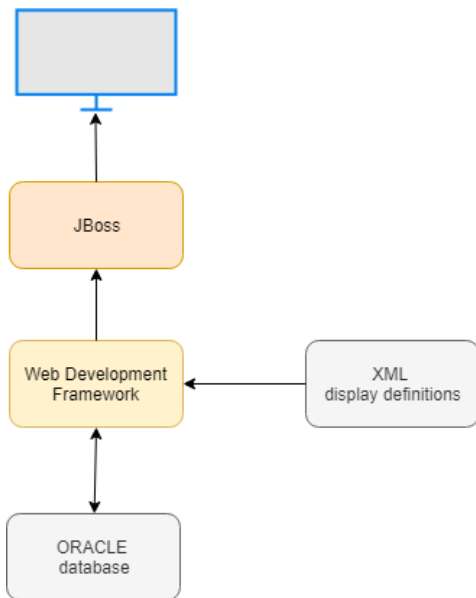

Figure 4. Display mechanism

The Oracle database is accessible mostly through packages written in PL/SQL. These PL/SQL packages contain procedures, functions and triggers used for controlled altering of the database, in order to keep it consistent<sup>[6]</sup>. They can also be directly called from our XML display configuration files, which can create and fetch data directly from the display.

In our example, to create a Service Order we need to first create an appropriate trouble ticket of the type: Service Order. There is a display used to fill out a form, which creates the trouble ticket. Some of the existing trouble ticket elements, for instance the customer complaint, are redundant in the definition of a Service

Order, but the existing implementation is missing appropriate data for the type of Service Order.

Figure 5. Trouble ticket

We want to specify this difference to the User. In order to do that, we will use a Java class, which as input gets the type of trouble ticket, and as output sends a value, which when set, enables or disables elements of the display, so that when the User selects the Service Order type, he can't choose data irrelevant to our ticket. The choices which a User can choose between, are directly linked from the Database via a query, which can take parameters (needed to determine types of Service Order). After the User submits the form, it is handled by a C process which determines the position of the User on the grid and appropriates the data for the Database. This data is interpreted by the procedure as an unidentified signal, which then gets its definition from the data it contains. Once determined, the trouble ticket, now having its own identification, is assigned various data about the installations affected, customers, similar Service Orders etc.

The picture below presents part of the integration between SCADA and OMS. Upon receiving a trouble ticket, OMS will have to trace the affected network in order to determine the first upstream switch to be used for the manipulation (deenergization of the work zone) and for registration of additional customers which may be affected by the switching operation.<sup>[5]</sup>

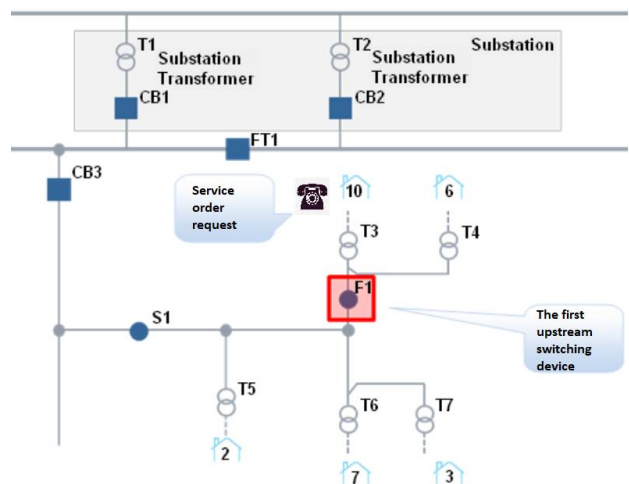

Figure 6. Network example

Based on the data, the trouble ticket will trigger the creation of an Outage. The outage at first using procedures gets an ID, and based on its type, gets basic information about the certain type of Outage it belongs to, as an example, a new planned work will get data specific to planned works. At the end, data specific to the outage is added. This Outage (in our case, new Service Order) is now ready to be displayed on the newly created Service Order tab.

Out. ID	Event Name	Last Name	City	Type	Center of Responsibility	Time of creation	EOP Code	User	Start	Destination	Record
7.1660021	...	...	...	...	...	08/22/2019 10:28	...	...	08/22/2019 10:28	...	Open
7.1660022	...	...	...	...	...	08/22/2019 10:27	...	...	08/22/2019 10:27	...	Open
7.1660023	...	...	...	...	...	08/22/2019 10:26	...	...	08/22/2019 10:26	...	Open
7.1660024	...	...	...	...	...	08/22/2019 10:25	...	...	08/22/2019 10:25	...	Open
7.1660025	...	...	...	...	...	08/22/2019 10:24	...	...	08/22/2019 10:24	...	Open

Figure 7. Service order tab

As seen in the picture, the tab contains a main table filled with all active Service Orders. The table needs many functionalities, such as editing and archiving the Service Order, viewing it on the grid map, assigning a crew to work on it, creating a task (job request), taking the ownership of a specific order (often, multiple users will work over one area, and see the same outages, so this allows splitting the work). In the bottom is a details card with various basic details, which by using our framework allows us to dynamically change the data to correspond to the Service Order that is selected in the table above. Data in the ID column of the main table is a hyperlink to a new pop-up window with further details related to the Service Order.

This window once opened, shows details only of the Service Order used to open it, by implementing Java

classes which fill a page filter with data in the link used to open the Service Order. This filter then dictates data in all of the controls shown inside a window. The newly opened window contains several tabs used to detail and control aspects related to the Service Order, and the Service Order itself.

### III. CONCLUSION

As shown in the article, a functionality extension of the existing system was implemented. Since the OMS is usually subject to customization during the customer projects, a lot of effort should be invested in order to have flexible architecture which would allow simple customizations. Ideally, adaptations of the system based on customer requirements should be an engineering rather than development task. It would reduce costs and risks on the projects, and would allow for simpler future system upgrades.

### REFERENCES

- [1] Sastry, M.K.S., "Integrated Outage Management System: an effective solution for power utilities to address customer grievances" *International Journal of Electronic Customer Relation Management* vol. 1, July 2007.
- [2] Stuart A. Boyer, "Supervisory Control and Data Acquisition, Fourth Edition" *USA:ISA – International Society of Automation* 2010.
- [3] Hall, D.F. "Outage Management Systems as integrated elements of the distribution enterprise", *IEEE/PES* volume 2, November 2001.
- [4] John J. Simmins, "The impact of PAP 8 on the Common Information Model (CIM)," *IEEE/PES Power Systems Conference and Exposition* March 2011.
- [5] Nielsen, T.D. "Improving outage restoration efforts using rule-based prediction and advanced analysis", *IEEE/PES Power Systems Winter Conference* January 2002.
- [6] Arup Nanda, Steven Feuerstein, "Oracle PL/SQL for DBAs", *O'Riley Series*, October 2005.

# Use of R Programming Language for Drought Monitoring in Vojvodina

J. Bondžić\*, M. Dujović\*, S. Popov\*\*, P. Marić\*\* and I. Šećerov\*\*\*

\* University of Novi Sad, Faculty of Technical Sciences, Department of Civil Engineering and Geodesy, Novi Sad, Serbia

\*\* University of Novi Sad, Faculty of Technical Sciences, Department of Computing and Automatics, Novi Sad, Serbia

\*\* University of Novi Sad, Faculty of Sciences, Department of Geography, Tourism and Hotel Management, Novi Sad, Serbia

jovanasimic@uns.ac.rs, miljandujovicmd@gmail.com, srdjanpopov@uns.ac.rs,  
petarmaric@uns.ac.rs, ivan.secerov@dgt.uns.ac.rs

**Abstract – Due to the increased frequency and intensity of the disaster events over the globe in the past few decades, the need for the advances in Disaster Risk Management discipline also increased. As the main goal of disaster risk experts is to prevent occurrence or reduce the impact of a disaster, monitoring systems for prompt detection of disaster become essential. Vojvodina is the region in northern Serbia where agriculture is one of the main source of income in the rural regions. Therefore, water shortage due to drought could seriously affect the rural population and cause substantial economic damage in the region. In order to overcome that, it is crucial to predict when and how droughts can occur, then the location and severity of the hazard. This paper describes the use of automatic monitoring stations for generating data series of environmental variables, with the aim of drought events detection in Vojvodina. SPEI function in R program language was used in computing the severity of drought.**

## I. INTRODUCTION

Over the past ten years, approximately 700 thousand people have lost their lives, over 1.4 million have been injured and 23 million have been made homeless because of disasters [1]. These evidences represent strong arguments to act within the field of Disaster Risk Management. Primarily, it is important to deal with causes of catastrophes, and afterward, it is necessary to comprehend different causes-consequences correlations regarding disaster impacts.

According to UNU Comparative Glossary [2], disaster risk is understood as a function of hazard, vulnerability, exposure, and resilience. A hazard is a dangerous phenomenon, substance, human activity or condition that may cause loss of life, injury or other health impacts, property damage, loss of livelihoods and services, social and economic disruption, or environmental damage [3]. Hazard can have different origins: natural (geological, hydro-meteorological and biological) or induced by human processes (environmental degradation and technological hazards) [4]. Vulnerability can be defined as the characteristics of a person or group in terms of their capacity to anticipate, cope with, resist and recover from impacts of a hazard [2, 3].

In understanding hazards, it is crucial to understand natural phenomena as well as social dynamics over the globe. Without vulnerability or hazard, there is no disaster. A disaster occurs when hazard and vulnerability meet [5]. Therefore, the goal of disaster risk experts is to prevent occurrence or reduce the impact of a disaster. In order to achieve the goal, it is necessary to analyse previously defined processes and phenomena. A prerequisite for the hazard and vulnerability analysis in any region or a location is acquiring data about natural and social behaviour in that region. To successfully acquire data, it is important to decide which indicators of disaster should be monitored. Data could be found on different sources or collected by different methods, consequently it comes in formats that are not interoperable. Accordingly, it should be organized and processed in order to retrieve information. Furthermore, certain disaster in a specific region requires own approach regarding indicator selection and data acquisition.

Serbia is exposed to various natural hazards, including earthquakes, floods, landslides, droughts, wildfires and storms [6]. According to EM-DAT (Emergency Events Database) [7], the most common disasters in Serbia are floods, earthquakes and extreme temperatures. Concerning technological disasters, transportation and industrial accidents have been occurred in the past.

Only in the past decade floods took 58 lives and affected 103616 people in Serbia. The most devastating flood happened in Serbia in May 2014 when heavy rains induced rapid rise of water levels in the Sava River and its tributaries. The NASA Earth Observatory's website described this event as the region's worst flood in more than 120 years [8]. These floods also led to landslides as a secondary hazard. Earthquakes in Serbia are common in the central and south part of the country. Earthquake that hit Kraljevo in November 2010 affected 27030 people and caused the death of 2 people. Extreme temperature impacts increased in the past decade in Serbia, especially severe winter conditions and cold waves that caused 36 deaths and affected 91734 people.

According to EM-DAT, droughts are not so noticeable disasters concerning the number of occurrences as well as the affected population and number of deaths. Although it is a slow-onset hazard, which occurs after prolonged time with high temperatures and without precipitation, in past

two decades increase in frequency and intensity of droughts has been observed in the Pannonian Basin i.e. Vojvodina region in Serbia.

Vojvodina is the region in northern Serbia where agriculture is one of the main source of income in the rural regions. Therefore, water shortage due to drought could seriously affect the rural population and cause substantial economic damage in the region. In order to overcome that, it is crucial to develop a monitoring system for detecting when and where will droughts occur and with witch intensity.

## II. DATA COLLECTION - SENSOR STATIONS

The experts of the University of Szeged, University of Novi Sad and Lower Tisza District Water Directorate achieved complex research to analyse possibilities in mitigation of drought problem and development of sustainable and adaptive water management in the frame of a Hungarian-Serbian Cross-border Project. As a result of this project, environmental monitoring systems were developed, environmental and social impacts were assessed and finally, plans and recommendations were outlined to support the realization of the sustainable development in the region.

Conduct complex research to determine the most important water shortage related conflicts, to measure and monitor drought events was the primary objective of the WAHASTRAT project. Based on WAHASTRAT system of automatic monitoring stations (WH1 to WH8, Figure 1 and Figure 2), data series of environmental variables were generated: soil moisture, speed and wind direction, air temperature, air humidity and atmospheric precipitation.



Figure 1 WAHASTRAT macro location

Whereby the moisture content in the soil describes the 6 measured values each distributed to 10cm vertically. Typology of data is a real scalar in floating-point format, for all monitored environmental variables, except for the moisture content in the soil, which is represented by a vector of real type. Data is stored after acquisition (local buffer of maximum 211 addressable location 10bit data) at intervals of 1 hour, sent with GPRS-a, the point of concentration is carried out transformation in the relational model. Web service, based on the data in a relational database, allows expressive visualization in tabular form series of two-dimensional model. Both forms of expressive renderings are suitable for data interpretation, its bringing into context, understanding of the information and decision-making.



Figure 2 WH8 micro location

The monitoring stations are connected to the internet over the 3G network, using the standard SIM cards, and appropriate built in 3G modems. Power supply is primarily provided by the solar panels. Data from the monitoring stations are sent as log files (Figure 3), WAHASTRAT time series. Communication is initiated from the monitoring station to the designated server. Application on server is processing received log files, analyzing data, creating statistical reports and data visualizations.

Vreme	Uredaj	ID vrednosti	Vrednost
15.9.2019. 22:35:09	3	SM1	15,377
15.9.2019. 22:35:09	3	SM2	21,185
15.9.2019. 22:35:09	3	SM3	19,733
15.9.2019. 22:35:09	3	SM4	20,221
15.9.2019. 22:35:09	3	SM5	23,124
15.9.2019. 22:35:09	3	SM6	22,636
15.9.2019. 22:35:09	3	BT1	75,219
15.9.2019. 22:35:09	3	AH1	86,000
15.9.2019. 22:35:09	3	AT1	15,550
15.9.2019. 22:35:09	3	PP1	0,000
15.9.2019. 22:35:09	3	WS1	0,000
15.9.2019. 22:35:09	3	WD1	192,000
15.9.2019. 22:27:18	2	SM1	22,636
15.9.2019. 22:27:18	2	SM2	21,185
15.9.2019. 22:27:18	2	SM3	22,636
15.9.2019. 22:27:18	2	SM4	14,889
15.9.2019. 22:27:18	2	SM5	19,733
15.9.2019. 22:27:18	2	SM6	21,672
15.9.2019. 22:27:18	2	BT1	17,324
15.9.2019. 22:27:18	2	AH1	82,000

Figure 3 WAHASTRAT time series

## III. DATA PROCESSING

### A. Software Package R

R is a language and environment for statistical processing and graphical representation (Figure 4) R Studio. It is a GNU project similar to the S language and environment of the programming language and was developed into Bell Laboratories by John Chambers and his colleagues. It can be considered as a different application of the S. programming language. Of course, there are some significant differences, but most code written for S can run in R in the unaltered state.

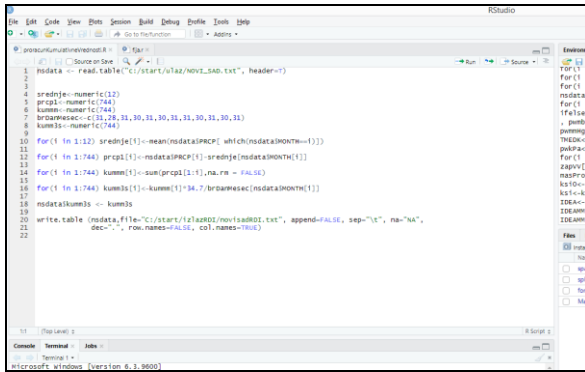

Figure 4. R Studio

R is an integral programming language for large data manipulation, calculation and graphical representation. Contains:

- efficiently managed data and storage,
- a set of operators for calculating arrays, matrices,
- a large coherent, integrated suite of data analysis software tools,
- graphical capabilities for analysing data and displaying it on screen or paper,
- A well-developed, simple and efficient programming language that includes conditions, loops, user-defined recursive functions, and input and output objects.

The term "environment" is intended to characterize it as a fully planned and coherent system rather than a system that is gradually supplemented with specific and inflexible software tools, which is often the case with other data analysis programs.

### B. The use of R spei functions

Early warning systems are an extremely important component of risk management, especially in the drought management process. The existence of such models allows us to identify current or upcoming hazards and provides a further assessment of the risks associated with the hazard. The main objective of the early warning system is to determine when and how droughts can occur, then the location and severity of the hazard. The implementation of the SPEI library is considered to be a proactive method of risk management as the core of forecasting and early warning. What is shown below is the application of the SPEI function in computing the severity of drought.

The SPEI fulfills the requirements of the drought index by allowing the multiscale character of the drought index to use the SPEI index in different scientific disciplines for drought detection, monitoring and analysis. Using the SPEI index, drought can be measured by intensity and duration and the beginning and end of a drought episode can be identified. Depending on the method of data collection, this feature allows the severity of droughts to be compared across time and space and can

be applied and accounted for across a wide range of climates.

Usage:

```

spei (data, scale, kernel = list
      (type = 'rectangular', shift =
        0),
      distribution = 'log-Logistic',
      fit = 'ub-pwm', na.rm = FALSE,
      ref.start = NULL, ref.end = NULL,
      x = FALSE, params = NULL, ...)
    
```

Arguments:

- Data - a vector, matrix or data frame with time-determined values of the difference in the climate balance of precipitation and the potential evapotranspiration in this case "Table SPEI".
- Scale - an integer, that is, an integer representing the time range taken as the reference over which the SPEI will be executed.
- Distribution - an optional query that allows the use of the desired regression model to calculate SPEI. The model used is logistic distribution.
- Kernel - an optional query that allows us to smooth out temporal variability of data, which means that by creating a kernel, we create a kernel of rectangular, triangular, circular or Gaussian shape. With this query, we determine the rigidity or smoothness of the function.
- Na.rm - an optional logical query to indicate whether to remove NA values from computation.
- Ref.start - indicates the starting point of the reference period used to calculate the index. The default value assigned is NULL indicating that the first value in "data" will be used as the initial value.
- Ref.end - indicates the endpoint of the reference period used to calculate the index. The default value assigned is NULL indicating that the last value in "data" will be used as the final value.

Performing an SPEI function over a time-series object "Table SPEI" for a 36-month reference range is presented at Figure 5. Numeric data can be extracted into a .txt file.

## IV. CONCLUSION

In order to be proactive in the disaster risk management practice, it is crucial to implement models for predicting the severity of drought. The use of SPEI libraries in R language enabled us to determine future behavior of drought i.e. intensity and duration of drought. Information about beginning and ending of the drought episode could save the rural inhabitants from yield loss and also economic damage could be avoided in the region.

```

> grafikSPEI36 = spei(TabelasPEI[, "Bilans"], 36)
> grafikSPEI36
      Jan      Feb      Mar      Apr      May      Jun      Jul
2015      NA      NA      NA      NA      NA      NA      NA
2016      NA      NA      NA      NA      NA      NA      NA
2017      NA      NA      NA      NA      NA      NA      NA
2018 -0.43205648 -0.84109153 -1.28875582  1.26408234 -0.24394723  1.16730283  1.32863476
2019 -1.28018859 -0.15922481 -0.02641530  1.77594214  1.77211566  1.01081967  0.98373347
2020 -0.27198563  0.60253581  1.78076530  0.64148761  0.67928312  1.59367075  1.25913982
2021 -0.70073844 -0.16876425 -0.98682099 -1.20212616  0.77422295 -0.84191741  0.31617215
2022 -0.22192060 -1.29399095  0.02436666 -0.22157388  1.28799414  0.97357666  0.11793372
2023 -0.21443490  0.08071024  1.12400193  0.68525235  0.16695245 -0.20442452  0.93239012
2024 -1.76050471 -0.56218577  0.01003243 -0.91078772 -1.51196317 -0.12290714 -1.37151883
2025 -0.06855174  0.16073187 -1.61356558 -0.19166274 -0.62848193  0.38651489  0.07301928
2026  0.72995687  0.17277056  0.38217142  0.38080172  0.20870895 -0.58795301 -0.98277115
2027  0.52245465 -1.79523355 -0.57977927 -0.20006012 -1.24628396 -1.45380646 -0.92684528
2028  0.69284690  0.41080624  0.49970913 -1.58020576 -0.60160020 -1.04968996 -0.52961771
2029  1.51753561  1.77857943  0.51729050  0.00793009 -0.07862701 -0.55980965 -1.22546820
2030  1.58664437  1.41573423
      Aug      Sep      Oct      Nov      Dec
2015      NA      NA      NA      NA      NA
2016      NA      NA      NA      NA      NA
2017      NA      NA      NA      NA      NA
2018 -0.59261652 -1.61911745 -1.50072935 -1.40321099 -0.77423274
2019  0.41676754 -0.42800738 -1.11623403 -0.88904828 -0.76935185
2020  1.29338498 -0.71389220 -1.07473401 -1.02906953 -1.82157604
2021  1.15418652 -0.94957560 -0.87164589 -0.91454973 -0.67395758
2022  0.51802094  0.46077885  0.02396795 -0.28695773 -0.12790255
2023  1.01477098  1.35733782 -0.17995123 -0.22790007 -0.27545205
2024 -0.38029605  1.23412893 -0.35289755  0.03869009 -0.15466493
2025 -0.58340080  0.58013366  0.63757962  0.87742847  0.48422875
2026  0.43453512  1.10403624  1.28013007  0.72273221  0.54199147
2027 -1.66775852 -0.62588585  1.18815675  0.57775406  0.79788810
2028 -0.62639180 -0.93533849  0.72027592  1.26860449  1.56941562
2029 -1.43001504  0.48204474  1.09253347  1.60733542  1.42887895
2030
> plot.spei(grafiksPEI36,main = "SPEI 36, stanica u Kaču")
    
```

Figure 5 Executing SPEI function

#### REFERENCES

- [1] N. Etinay, C. Egbu, and V. Murray, "Building Urban Resilience for Disaster Risk Management and Disaster Risk Reduction," 7<sup>th</sup> International Conference on Building Resilience; Using scientific knowledge to inform policy and practice in disaster risk reduction, ICBR2017, 27 – 29 November 2017, Bangkok, Thailand, Procedia Engineering 212 (2018), pp. 575–582.
- [2] K. Thywissen, "Components of Risk, A Comparative Glossary", UNU Institute for Environment and Human Security (UNU-EHS) D-53113 Bonn, Germany
- [3] R. L. Ciurean, D. Schröter and T. Glade (April 17<sup>th</sup>, 2013). "Conceptual Frameworks of Vulnerability Assessments for Natural Disasters Reduction, Approaches to Disaster Management - Examining the Implications of Hazards, Emergencies and Disasters", John Tiefenbacher, IntechOpen, DOI: 10.5772/55538. Available from: <https://www.intechopen.com/books/approaches-to-disaster-management-examining-the-implications-of-hazards-emergencies-and-disasters/conceptual-frameworks-of-vulnerability-assessments-for-natural-disasters-reduction>, accessed 29<sup>th</sup> August 2019.
- [4] UNISDR. Living with Risk. A global review of disaster reduction initiatives: United Nations, 2004, Available from: [https://www.unisdr.org/files/657\\_lwr1.pdf](https://www.unisdr.org/files/657_lwr1.pdf), accessed 29<sup>th</sup> August 2019.
- [5] A. S. Arya, A. Karanth and A. Agarwal, "Hazards, Disasters and your Community", National Disaster Management Division Ministry of Home Affairs, New Delhi, India, Available from: [https://www.preventionweb.net/files/2153\\_VL323103.pdf](https://www.preventionweb.net/files/2153_VL323103.pdf), accessed 12<sup>th</sup> September 2019.
- [6] Comprehensive analysis of the disaster risk reduction and management system for the agriculture sector in Serbia, Food and Agriculture Organization of the United Nations, Available from: <http://www.fao.org/3/I8364EN/i8364en.pdf>, accessed 14<sup>th</sup> September 2019.
- [7] EM-DAT, The International Disaster Database, Centre for Research on the Epidemiology of Disasters – CRED, Available from: <https://www.emdat.be/>, accessed 14<sup>th</sup> September 2019.
- [8] S. Bajić, S. Popov, "Flood Hazard Analysis – GIS Aspects of Possible Solution", Fresenius Environmental Bulletin, Vol. 26, No 8, 2017

# Exploring LoRa Technology Application in Smart Cities

D. Dobrilovic\*, D. Tokody\*\*, Ž. Stojanov\* and M. Malić\*\*\*

\*University of Novi Sad /Technical Faculty "Mihajlo Pupin", Zrenjanin, Serbia

\*\*Obuda University, Budapest, Hungary

\*\*\*Panonit, Novi Sad, Serbia

dalibor.dobrilovic@uns.ac.rs; daniel\_tokody@ieee.org; zeljko.stojanov@uns.ac.rs; milanmalic@outlook.com

**Abstract** –In recent period, low-power wide-area networks (LPWANs) have become a popular low-rate long-range radio communication group of technologies applicable in variety of Internet of Things (IoT) systems. LPWAN is a type of wireless telecommunication wide area network designed for long-range communications at a low bit rates. This kind of communication is planned for data exchange between the "things" or variety of objects such as sensors, actuators and other devices deployed mainly at outdoor spaces using batteries as main power source. Considering that LPWAN enables long range communications, especially in urban and suburban areas, it is interesting to investigate the usage of those technologies in Smart City scenarios. This paper investigates the utilization of LoRa technology in several use cases for Smart City environments as well as with the LoRa performance analytics.

## I. INTRODUCTION

In recent period, low-power wide-area networks (LPWAN) have become a popular low-rate long-range radio communication group of technologies applicable in variety of Internet of Things (IoT) systems. Their suitability for IoT environments comes from the fact that LPWAN is a type of wireless telecommunication wide area network designed for long-range communications at a low bit rates. Such kind of communication is widely applicable for data exchange between the "things" or variety of objects needed for IoT systems such as sensors, actuators and other devices deployed mainly at outdoor spaces and using batteries as main power source.

Considering that LPWAN enables long range communications, especially in urban and suburban areas, it is interesting to investigate the usage of those technologies in Smart City scenarios.

At the start, it is important to define the term Smart City. A Smart City can be explained as environment that uses currently available ICT technologies to improve living conditions by allowing access to information about parameters that enhance lives of its inhabitants. These parameters can be different and can range from status of their education and employment possibilities, available utilities for citizens, transportation information, energy consumption information, health-related issues, water and air quality monitoring, waste management and other relevant information that potentially could benefit the community [1].

In order to better explain the complexity of Smart City we can use the classification of numerous Smart City

application presented in [2]. In this source the variety of groups of Smart City applications are presented with brief explanation. These groups of Smart City applications are: Smart urban area management, Smart environment, Smart industry, Smart economics, Smart human mobility and Smart infrastructure.

This paper investigates the utilization of LoRa technology with the example of several representative use cases for Smart City environments. Together with the representation of use cases, this paper gives the overview of the researches that analyze LoRa technology performance. This overview is supported with both field measurements from different sources and models of performance analytics.

This paper is structured as follows. After the Introduction section, brief LP-WAN technology description is given. Next, the presentation of LoRa technology use cases is presented together with the experience collected during their implementation and operation. Next, the LoRa field measurements are analyzed with the appliance of different radio propagation models in order to check the model accuracy and applicability in the case of LoRa. At the end, the concluding remarks are given.

## II. LP-WAN TECHNOLOGIES

When we are speaking of LPWAN we should be aware that there is variety of different technologies on the market. Their detailed and summarized presentation can be found in [3]. The most representative of these technologies are [3]:

- DASH7, a low latency, bi-directional firmware standard that operates over multiple LPWAN radio technologies including LoRa,
- Sigfox, both UNB-based technology and French company,
- LoRa, a proprietary, chirp spread spectrum (CSS) radio modulation technology for LPWAN used by LoRaWAN,
- Weightless, an open standard, narrowband technology for LPWAN used by Ubiik
- LTE.advanced Machine Type Communications (LTE-M), represents an evolution of LTE communications for connected things by 3GPP.



- MySensors, DIY Home Automation framework supporting different radios including LoRa.
- NarrowBandIoT (NB-IOT), standard defined by 3GPP for a LPWAN used in cellular networks, etc

### III. LoRa TECHNOLOGY IN SMART CITIES

Nowadays, LoRa technology is gaining attention in both academia and industry by offering the possibility of connecting a large number of nodes over extended distances [4]. In this section, the examples of LoRa technology usage will be given. The presented researches are selected for presentation to justify the usage of LoRa technologies in Smart City applications.

#### A. LoRa performance and range experience

In [5] a performance evaluation of LoRaWAN is performed in three real scenarios, urban, suburban, and rural, considering both dynamic and static conditions. The research revealed that in the urban and suburban scenarios coverage goes up to 6 km; while in the open scenario (rural), a transmission distance of over 18 km was achieved. This research concluded that within urban distances shorter than 3 km, high data-rates are applicable. While in the case when the distance between receiver and transmitter is enlarged, lower data-rates increase the link robustness but decrease the transmission rate. Considering the urban scenarios with station mobility, LoRaWAN shows a notable vulnerability related to the Doppler effect with high transmission data-rates. This effect is much less notable in the case of using low data-rates. All findings lead to conclusion that LoRaWAN has a high level of adaptability in several IoT applications, such as smart cities, fleet/goods tracking, etc.

Another research concerning LoRa coverage is presented in [6]. In this work the focus is on evaluating the performance of two different-nature modulations for providing connectivity to IoT end-devices. The experiments findings show that transmission range of over 10 km is achieved in a suburban scenario with slower data-rates. With faster data-rates the coverage range was reduced down to 7 km. Both distances prove LoRa usability for a plethora of smart-city applications.

The research [7] provides a comprehensive and comparative study of LPWAN technologies, which serve as efficient solutions to connect smart, autonomous, and heterogeneous devices. The researches show that Sigfox and LoRa have advantage in terms of battery lifetime, as the lower-cost devices and very long range (high coverage). Additionally, unlike Sigfox, LoRa will also be useful in local network deployment and reliable communication for moving devices at high speeds. NB-IoT offers benefits in terms of low latency and high quality of service targeting higher-value IoT markets.

Authors in [8] present an extensive experimental study of the reliability of LoRa. The evaluation is focused on the impact of physical layer settings on the effective data rate and energy efficiency of communications and study of the impact of environmental factors on the performance of LoRa. The later study results show that higher temperatures significantly decrease the received signal

strength and may drastically affect packet reception. If the temperature rises over a range of 60°C, the received signal strength is consistently reduced by 6dBm (1 dBm/10°C). This decrease in signal strength can significantly affect LoRa links that are at the edge of the communication range.

The research [9] presents analysis of the use of LoRaWAN in a large-scale demonstrator of the Smart City. The research is conducted both outdoor and indoor at the Scientific Campus of the University of Lille in the North of France. The Campus has around 145 buildings. During the test only one gateway is used. Test showed that LoRaWAN technology provides good performances over the major part of the Campus.

The extensive research is made in Padova [10] and the experience from that research is also positive.

#### B. Examples of LoRa technology utilization in Smart City applications

In this subsection the use cases of using LoRa in Smart City environment will be presented. The research [11] proposed a Smart City multi-wireless technology communication platform for data gathering and exchange. This platform combines proprietary long-range (LoRa) network and an urban sensor network. It also implements mobile Opportunistic VEHicular (mOVE), a delay-tolerant network (DTN)-based architecture to address the mobility dimension. The platform provides vehicle-to-everything (V2X) communication. The sensor nodes has variety of sensors such as temperature; luminosity; wind direction; wind speed; carbon dioxide (CO<sub>2</sub>); sound detection; humidity; precipitation; barometric pressure; multiGas (CO, CH<sub>4</sub>, NH<sub>3</sub>) and UV index sensors.

The obtained results showed that, regarding the LoRa technology, there are some losses of packets. Those losses were not caused with the poor performance of LoRa MAC protocol, but because of geographical areas that belong to the routes where there is a lack of connectivity to any of the LoRa gateways that are already installed in the city.

In the research [12] the classification of smart parking systems is presented, together with the overview of the enabling technologies and sensors. Among the communication technologies which can be used in smart parking systems LoRaWAN, Sigfox, Weightless (SIG), Ingenu, LTE-M and NB-IoT are considered. The conclusion is that in the case of large-scale smart parking applications where low latency is necessary, NB-IoT and LTE-M are probably the best options.

The design and implementation of a wireless sensor network based on the LoRa protocol is presented in [13]. Sensor nodes have embedded sensors for temperature, humidity, luminance, carbon monoxide, methane, alcohol and smoke detection. The collected data are transmitted to a base station (gateway) using LoRa. Further, collected data are forwarded and uploaded to the cloud using GPRS technology.

According to [14] it can be concluded that among other targeted technologies, LoRa can meet the needs and requirements of the common smart metering applications (gas, water, electricity, and garbage), civil engineering and

road infrastructure monitoring (e.g. tunnels, bridges, and buildings), environment conditions (pollution and climate, tracking of vehicles (e.g. cars, bicycles, and motorcycles), as well as for monitoring the inhabitants, etc. Also, the findings of the research suggest that, considering typical end device densities, a single LoRa network may cover an area of few kilometers in an urban zone and up to 30 km in a suburban zone.

The smart lighting application is described in [15]. The scenario includes around 3,000 light poles and represents flexible and modular implementation of a public lighting infrastructure. In the same research, the smart-building testbed is investigated. In the case of using LoRa in real urban scenarios, results show that a proper parameter setting is needed to cover large urban areas in order to keep packet losses at satisfactory levels. The performance tests show that maximum coverage in a dense urban environment is within 1–2 km, which is well below the 15 km claimed by LoRa manufacturers and vendors. For the research purposes one gateway is used and it is placed at a height of 71 m. Because of such good position of gateway (receiver) it is expected that the coverage could be even lower when conditions are worse. Additionally, this paper showed the importance of tuning spreading factor adopted by the transmitter, in order to maximize the packet success rate in point-to-multipoint communications. For better coverage of entire district the deployment of multiple LoRa gateways is desirable.

For the example of using LoRaWAN in smart grids we can use [16].

The research described in [2] deals with variety of data sources that are created with the emergence of smart city applications. The common technique for handling multiple data sources is data fusion. This work introduces a multi-perspective classification of the data fusion to evaluate the smart city applications. Besides the data fusion classification, this paper gives very good Smart city applications overview.

#### IV. LoRa TECHNOLOGY PROPAGATION ANALYTICS

Smart City environments are in a large extent based on wireless technology and according to [17, 18], the radio propagation conditions and their statistical characteristics seriously affect the operation of wireless communication systems as well as their performance. So, in the process of planning of Smart City nodes deployment it is crucial to understand the characteristics of wireless communication channels. Three factors that make great impact on wireless channel are path loss, shadowing, and multipath fading. Path loss represents the decay of signal power as it propagates through space. Path loss may be due to many effects, such as free-space loss, refraction, diffraction, reflection, aperture-medium coupling loss, and absorption.

The following formula is used for calculation of expected received signal level or Received Signal Strength Indication (RSSI).

$$P_{rx} = P_{tx} + G_{tx} - L_{tx} - L_{pl} - L_m + G_{rx} - L_{rx} \quad (1)$$

In presented formula  $P_{rx}$  represents received power (dBm),  $P_{tx}$  represents transmitter output power (dBm),  $G_{tx}$  is transmitter antenna gain (dBi),  $L_{tx}$  is transmitter losses

(coax, connectors...) (dB),  $L_{pl}$  is propagation loss or path loss (dB),  $L_m$  is miscellaneous losses (fading margin, body loss, polarization mismatch, other losses...) (dB),  $G_{rx}$  is receiver antenna gain (dBi) and  $L_{rx}$  is receiver losses (coax, connectors...) (dB).

Since  $L_{rx}$ ,  $L_{tx}$  and  $L_m$  can be very small and because of that irrelevant to accuracy of calculating RSSI, following formula can be reduced to:

$$P_{rx} = P_{tx} + G_{tx} + G_{rx} - L_{pl} \quad (2)$$

The parameter  $L_{pl}$  can be calculated by the number of propagation models such as: Okumura-Hata, COST231, Stanford University Interim (SUI), Ericsson 9999, ECC-33, Winner II, Egli, etc. [18, 19, 20]. In the following text some of the most applicable models such as Ericsson 9999, ECC-33, Okumura-Hata and Lee will be presented and used to analyze their accuracy with LoRa field measurements.

##### A. Okumura-Hata model

Okumura-Hata propagation model is one of the most widely used models and in the same time it represents the base for development of numerous other models. Model is initially created by Okumura and expanded by Masaharu Hata. Model has variants for urban and suburban areas. [18, 19, 20]. The following parameters of propagation and environment parameters are included in model: antenna heights and frequency, sub-urban, free-space or hill areas, diffraction losses in hilly areas and seaside and lakeside areas etc.

Hata defined propagation formulae (3), with the addition of correction parameters.

$$L_{50}(urban) = 69.55 + 26.16 \log f_c - 13.82 \log h_b + 44.9 - 6.55 \log h_m \log d - a(h_m) \text{ dB} \quad (3)$$

The parameters are as follows:

- $f_c$  - frequency in MHz in range between 150 MHz and 1,500 MHz,
- $h_b$  - effective transmitter antenna height in meters, in range between 30m to 200m,
- $h_m$  - effective transmitter antenna height in meters, in range between 1m to 10m,
- $d$  - distance between a transmitter and a receiver in km, in range between 1km to 20km
- $a(h_m)$  - correction factor for effective antenna height as a function of dimension of covered area.

Correction factor depends of the environment and for large cities is calculated as follows:

$$a(h_m) = 8.29 [\log(1.54h_m)]^2 - 1.1, f_c \leq 300 \text{ MHz} \quad (4)$$

$$a(h_m) = 3.2 [\log(11.75h_m)]^2 - 4.97, f_c \geq 300 \text{ MHz} \quad (5)$$

Correction factor for small and medium cities is:

$$a(h_m) = [1.1 \log(f_c) - 0.7]h_m - [1.56 \log(f_c) - 0.8] \quad (6)$$

Path loss in sub-urban areas is calculated with:

$$L_{50} = L_{50}(urban) - 2 \left( \log \left( \frac{f_c}{28} \right) \right)^2 - 5.4 \text{ [dB]} \quad (7)$$

And in rural areas with:

$$L_{50} = L_{50}(\text{urban}) - 4.78(\log f_c)^2 + 18.33 \log f_c - 40.94 \text{ [dB]} \quad (8)$$

Okumura-Hata model presents a great opportunity when used with LoRa and other sub-Gigahertz technologies, but cannot be applied to 2,4GHz technologies such as ZigBee. Okumura-Hata model is later expanded with the COST-231 model, to be applicable for frequencies between 1,500MHz to 2,000MHz. It will not be discussed in this paper since the wireless technologies we are discussing do not operate in this frequency range.

#### B. Ericsson 9999 Model

Ericsson 9999 model is a variant of Hata model designed in Ericsson. Also this model has several variants depending on the area type [19, 22,23]. The model has following formula:

$$PL[\text{dB}] = a_0 + a_1 \cdot \log_{10}(d) + a_2 \log_{10}(h_b) + a_3 \cdot \log_{10}(h_b) \cdot \log_{10}(d) - 3.2 \cdot (\log_{10}(11,75 \cdot h_m))^2 + g(f) \quad (9)$$

where  $a_0$ ,  $a_1$ ,  $a_2$  and  $a_3$  parameters depends on the environment (urban, suburban, rural). Their values are presented in Table I and  $g(f)$  is calculated as:

$$g(f) = 44,49 \cdot \log(f) - 4,78(\log(f))^2 \quad (10)$$

Table I.

Parameter values for Ericsson 9999 propagation model

Area	$a_0$	$a_1$	$a_3$	$a_4$
Urban	36,2	30,2	12,0	0,1
Sub-urban	43,20*	68,93*	12,0	0,1
Rural	45,95	100,6*	12,0	0,1

\*Parameter values for  $a_0$  and  $a_1$  for sub-urban and rural areas are based on Least Square (LS) method used in [24].

#### C. Lee Propagation Model

The Lee model was originally developed for use at 900MHz band [20]. Propagation path loss is calculated with following formulae depending on the environment:

$$L_p = 96.92 + 20.0 \log_{10} d + 10 n \log_{10} \left( \frac{f}{900} \right) - \alpha_0 \quad (11)$$

for free space

$$L_p = 82.16 + 43.5 \log_{10} d + 10 n \log_{10} \left( \frac{f}{900} \right) - \alpha_0 \quad (12)$$

for open area

$$L_p = 99.86 + 38.4 \log_{10} d + 10 n \log_{10} \left( \frac{f}{900} \right) - \alpha_0 \quad (13)$$

for suburban area

$$L_p = 108.49 + 35.8 \log_{10} d + 10 n \log_{10} \left( \frac{f}{900} \right) - \alpha_0 \quad (14)$$

for Philadelphia

$$L_p = 101.20 + 43.1 \log_{10} d + 10 n \log_{10} \left( \frac{f}{900} \right) - \alpha_0 \quad (15)$$

for Newark

$$L_p = 123.77 + 30.5 \log_{10} d + 10 n \log_{10} \left( \frac{f}{900} \right) - \alpha_0 \quad (16)$$

for Tokyo

Further,  $\alpha_0$  is calculated by following formula:

$$\alpha_0 = \alpha_1 \cdot \alpha_2 \cdot \alpha_3 \cdot \alpha_4 \cdot \alpha_5 \quad (17)$$

where  $\alpha_1$  is base antenna height correction factor;  $\alpha_2$  is mobile antenna height correction factor;  $\alpha_3$  is mobile antenna gain correction factor;  $\alpha_4$  is base antenna gain correction factor and  $\alpha_5$  is frequency adjustment factor.

#### D. ECC-33 model

ECC-33 [27] is designed to be applicable for frequencies and European urban areas not suited for Okumura-Hata and its extension models such as COST-231. According to this model path loss is defined as:

$$PL = A_{fs} + A_{bm} - G_b - G_r \quad (18)$$

Where  $A_{fs}$ ,  $A_{bs}$ ,  $G_b$  and  $G_r$ , represents free space attenuation, the basic median path loss, base station height gain factor and terminal height gain factor.

$$A_{fs} = 92.4 + 20 \cdot \log_{10}(d) + 20 \cdot \log_{10}(f) \quad (19)$$

$$A_{bm} = 20.41 + 9.83 \cdot \log_{10}(d) + 7.894 \cdot \log_{10}(f) + 9.56 [\log_{10}(f)]^2 \quad (20)$$

$$G_{bm} = \log_{10}(h_b/200) \{13.958 + 5.8 [\log_{10}(d)]^2\} \quad (21)$$

For medium city environments  $G_r$  is:

$$G_r = [42.47 + 13.7 \log_{10}(f)] [\log_{10}(h_r) - 0.585] \quad (22)$$

For large city environment  $G_r$  is:

$$G_r = 0.759 \cdot h_r + 1.862 \quad (23)$$

The rest of parameters  $f$ ,  $d$ ,  $h_b$  and  $h_m$  are the same as in other models.

## V. RESULTS AND DISCUSSION

For the purpose of analyses LoRa performances, the results from the field measurements from three different sources are used. The accuracy of model calculations is tested with real field RSSI data. All four presented models are used. First source was [18] and it is marked as S1 in Table II. This research is made in Zrenjanin, Serbia in 2017 at 17 measurement locations. The second source is [25] and in Table II it is marked as S2. The LoRa field measurements are conducted in Offenburg, Germany in 2014.

The last source [26] is marked as S3 in Table II. The 4 outdoor locations are used in this research. The measurements are also made at 4 indoor locations, but those locations are removed from the data sample, because of different environment and possibility that different environment will have negative impact on research results. The plan is to include those 4 indoor locations in next phases of the research.

For the following analyses the Octave script is used. The research used a model calculated RSSI signal values and compared these values with measured ones. Calculated values using Okumura-Hata model for 868MHz frequency communication for field data for S3 (Dortmund) in different environments are shown in Fig. 1. The four different environments are: large cities, small/medium cities, sub-urban and rural environment. The

propagation loss prediction is given for the distance range from 0 to 9 km.

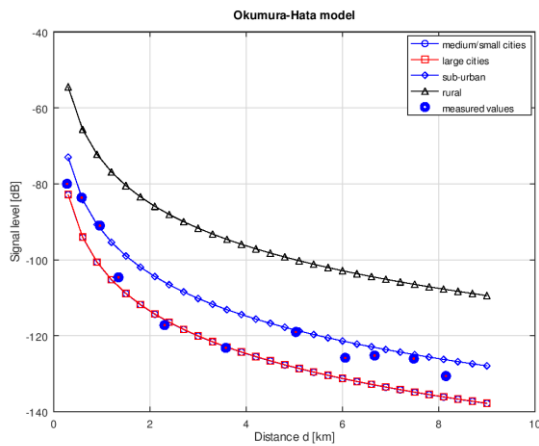

Fig. 1 Okumura-Hata model for S3 source

Calculated values using ECC-33 model for 868MHz frequency communication for field data for S1 (Zrenjanin) are shown in Fig. 2. for medium and large cities.

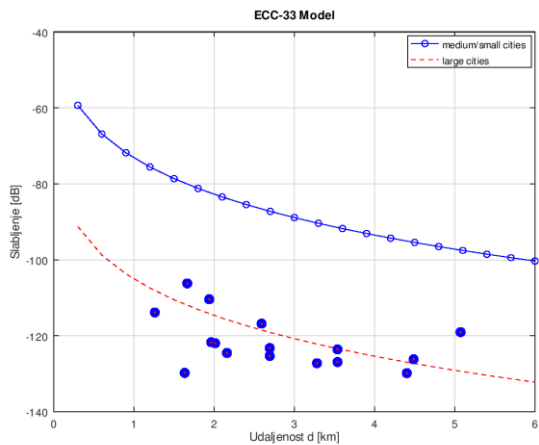

Fig. 1 ECC-33 model for S1 source

Root mean square error (RMSE) is used for the analyses of model accuracy. The results are presented in Table II. In this table 4 propagation models and their variants are compared for three scenarios. Total number of models is 15.

Table II.  
 Radio propagation model accuracy

Model	Area	Source	RSME(dBm)
Lee	Philadelphia	S1	15.0949
Lee	Newark	S1	19.5495
Lee	Tokyo	S1	6.71731
Lee	Suburban	S1	22.5351
Lee	Rural	S1	33.9622
Lee	Free Space	S1	42.1714
Ericsson9999	Urban	S1	9.3216
Ericsson9999	Suburban	S1	21.013
Ericsson9999	Rural	S1	35.122
ECC-33	Urban – large cities	S1	10.362
ECC-33	Urban – medium / small	S1	37.360
Okumura-Hata	Large cities	S1	11.252
Okumura-Hata	Medium-small cities	S1	11.216
Okumura-Hata	Suburban	S1	18.853
Okumura-Hata	Rural	S1	36.194
Lee	Philadelphia	S2	11.046

Lee	Newark	S2	7.8718
Lee	Tokyo	S2	23.967
Lee	Suburban	S2	4.9770
Lee	Rural	S2	14.096
Lee	Free Space	S2	11.460
Ericsson9999	Urban	S2	7.6692
Ericsson9999	Suburban	S2	15.904
Ericsson9999	Rural	S2	29.493
ECC-33	Urban – large cities	S2	9.0767
ECC-33	Urban – medium / small	S2	24.540
Okumura-Hata	Large cities	S2	6.7887
Okumura-Hata	Medium-small cities	S2	6.8364
Okumura-Hata	suburban cities	S2	6.0251
Okumura-Hata	Rural cities	S2	23.292
Lee	Philadelphia	S3	8.1046
Lee	Newark	S3	8.2822
Lee	Tokyo	S3	16.291
Lee	Suburban	S3	9.8747
Lee	Rural	S3	22.501
Lee	Free Space	S3	19.886
Ericsson9999	Urban	S3	16.368
Ericsson9999	Suburban	S3	27.186
Ericsson9999	Rural	S3	40.510
ECC-33	Urban – large cities	S3	8.2935
ECC-33	Urban – medium / small	S3	35.009
Okumura-Hata	Large cities	S3	8.0782
Okumura-Hata	Medium-small cities	S3	8.0690
Okumura-Hata	suburban cities	S3	13.696
Okumura-Hata	Rural cities	S3	30.692

## VI. CONCLUSION

The radio propagation model analyses results and RMSE calculations show that for the source S1 following models are the most accurate: Lee Tokyo (6.71731 dBm), Ericsson 9999 Urban (9.3216dBm) ECC-33 Urban – large cities (10.362dBm), Okumura-Hata Large cities (11.252dBm) and Okumura-Hata Medium-small cities (11.216dBm).

For the S2 source, Lee Newark (7.8718dBm), Lee Suburban (4.9770dBm), Ericsson9999 Urban (7.6692dBm), ECC-33 Urban – large cities (9.0767dBm), Okumura-Hata Large cities (6.7887dBm), Okumura-Hata Medium-small cities (6.8364dBm) and Okumura-Hata suburban cities (6.0251 dBm) are the most accurate models.

Finally, for S3 the source, Lee Philadelphia (8.1046dBm), Lee Newark (8.2822dBm), Lee Suburban (9.8747 dBm), ECC-33 Urban – large cities (8.2935dBm), Okumura-Hata Large cities (8.0782 dBm) and Okumura-Hata Medium-small cities (8.0690dBm) have highest accuracy.

Generally, for all three sources all four models, with at list one variant of model, seem to be sufficiently accurate. This fact leads to the conclusion that all models can be used for estimation of signal strength in LoRa networks. Additionally, this analyses show that LoRa technology implementation and deployment can be planned with high accuracy. Further research should be done in order to make these models more accurate.

Based on the experience of other researchers presented in Section III.A it can be concluded that LoRa technology is efficient up to 3km with higher, and up to 6 km with lower data rates. The range and performance heavily depends on environmental conditions and configuration.

The conclusion is that in the case of large-applications where low latency is necessary, NB-IoT and LTE-M are probably the best options comparing to LoRa, but the later is applicable as well.

Based on the experience of other researchers presented in Section III.B it can be concluded that LoRa technology can be used in smart parking, smart metering applications (gas, water, electricity, and garbage), civil engineering and road infrastructure monitoring (e.g. tunnels, bridges, and buildings), environment conditions (pollution and climate, tracking of vehicles (e.g. cars, bicycles, and motorcycles), as well as for monitoring the city inhabitants. All this findings justify usage of LoRa technology in Smart City applications.

#### ACKNOWLEDGMENT

Ministry of Education, Science and Technological Development of the Republic of Serbia, supports this research under the project "The development of software tools for business process analysis and improvement", project number TR32044, 2011-2019

#### REFERENCES

- [1] Carol L. Stimmel, *Building Smart Cities: Analytics, ICT, and Design Thinking*, 1st Ed., Auerbach Publications, August 13, Boston, USA, 2015.
- [2] Billy Pik Lik Lau, Sumudu Hasala Marakkalage, Yuren Zhou, Naveed Ul Hassan, Chau Yuen, Meng Zhang, U-Xuan Tan, *A survey of data fusion in smart city applications*, *Information Fusion*, Vol. 52, 2019, pp 357-374, <https://doi.org/10.1016/j.inffus.2019.05.004>
- [3] D. Dobrilović, "Networking Technologies for Smart Cities: An Overview", *Interdisciplinary Description of Complex Systems*, Vol.16, No. 3-A, pp. 408-416, 2018. [Online]. <https://doi.org/10.7906/indescs.16.3.13>
- [4] N. Jovalekic, V. Drndarevic, E. Pietrosevoli, I. Zennaro, "Experimental Study of LoRa Transmission over Seawater", *Sensors (Basel)*, 2018 Aug 29;18(9):2853. doi: 10.3390/s18092853. PMID: 30158501; PMCID: PMC6163321
- [5] Ramon Sanchez-Iborra, Jesus Sanchez-Gomez, Juan Ballesta-Viñas, Maria-Dolores Cano, and Antonio F. Skarmeta, "Performance Evaluation of LoRa Considering Scenario Conditions", *Sensors (Basel)*. 2018 Mar; 18(3): 772., Published online 2018 Mar 3. doi: 10.3390/s18030772
- [6] J. Sanchez-Gomez, R. Sanchez-Iborra and A. Skarmeta, "Transmission Technologies Comparison for IoT Communications in Smart-Cities," *GLOBECOM 2017 - 2017 IEEE Global Communications Conference*, Singapore, 2017, pp. 1-6., doi: 10.1109/GLOCOM.2017.8254530
- [7] Kais Mekki, Eddy Bajic, Frederic Chaxel, Fernand Meyer, A comparative study of LPWAN technologies for large-scale IoT deployment, *ICT Express*, Vol. 5, Issue 1, 2019, pp 1-7, <https://doi.org/10.1016/j.icte.2017.12.005>.
- [8] Cattani, M.; Boano, C.A.; Römer, K. An Experimental Evaluation of the Reliability of LoRa Long-Range Low-Power Wireless Communication. *J. Sens. Actuator Netw.* 2017, 6(2), 7. <https://doi.org/10.3390/jsan6020007>
- [9] M. Loriot, A. Aljer and I. Shahrour, "Analysis of the use of LoRaWan technology in a large-scale smart city demonstrator," *2017 Sensors Networks Smart and Emerging Technologies (SENSET)*, Beirut, 2017, pp. 1-4., doi: 10.1109/SENSET.2017.8125011
- [10] M. Centenaro, L. Vangelista, A. Zanella and M. Zorzi, "Long-range communications in unlicensed bands: the rising stars in the IoT and smart city scenarios," in *IEEE Wireless Communications*, vol. 23, no. 5, pp. 60-67, October 2016. doi: 10.1109/MWC.2016.7721743
- [11] Almeida R, Oliveira R, Luís M, Senna C, Sargento S. "A Multi-Technology Communication Platform for Urban Mobile Sensing". *Sensors (Basel)*. 2018 Apr; 12;18(4). pii: E1184. doi: 10.3390/s18041184. PubMed PMID: 29649175; PubMed, Central PMCID: PMC5948508.
- [12] Fadi Al-Turjman, Arman Malekloo, Smart parking in IoT-enabled cities: A survey, *Sustainable Cities and Society*, Vol. 49, 2019, 101608, <https://doi.org/10.1016/j.scs.2019.101608>.
- [13] K. Tzortzakis, K. Papafotis and P. P. Sotiriadis, "Wireless self powered environmental monitoring system for smart cities based on LoRa," *2017 Panhellenic Conference on Electronics and Telecommunications (PACET)*, Xanthi, 2017, pp. 1-4., doi: 10.1109/PACET.2017.8259970
- [14] Juha Petäjäjärvi, Konstantin Mikhaylov, Marko Pettissalo, Janne Janhunen, Jari Iinatt, Performance of a low-power wide-area network based on LoRa technology: Doppler robustness, scalability, and coverage, *Vol. 13 issue: 3*, Article first published online: March 17, 2017; Issue published: March 1, 2017
- [15] Pasolini G, Buratti C, Feltrin L, Zabini F, De Castro C, Verdone R, Andrisano O, Smart City Pilot Projects Using LoRa and IEEE802.15.4 Technologies, *Sensors (Basel)*. 2018 Apr 6;18(4). pii: E1118. doi: 10.3390/s18041118.
- [16] Lain-Chyr Hwang, Chao-Shun Chen, Te-Tien Ku, Wei-Cheng Shyu, A bridge between the smart grid and the Internet of Things: Theoretical and practical roles of LoRa, *International Journal of Electrical Power & Energy Systems*, Vol. 113, 2019, pp 971-981, <https://doi.org/10.1016/j.ijepes.2019.06.001>.
- [17] Lee, B. G., Park, D., & Seo, H. (2009). *Wireless communications resource management*. Singapore: John Wiley & Sons (Asia) Pte Ltd.
- [18] D. Dobrilović, M. Malić, D. Malić, S. Sladojević, Analyses and Optimization of Lee Propagation Model for LoRa 868MHz Network Deployments in Urban Areas, *Journal of Engineering Management and Competitiveness (JEMC)*, Vol. 7, No. 1, pp 55-62, 2017.
- [19] Theodore S. Rappaport, *Wireless Communications: Principles and Practice (2nd Edition)*, Pearson Education, 2002.
- [20] John S. Seybold, *Introduction to RF propagation*, John Wiley & Sons, Inc., New Jersey, USA, 2005.
- [21] J. D. Parsons, *Mobile Radio Propagation Channel*, John Wiley & Sons Ltd., 2ed, New York, USA, 2000.
- [22] J. Milanovic, S. Rimac-Drlje and K. Bejuk, "Comparison of Propagation Model Accuracy for WiMAX on 3.5GHz", *14th IEEE International Conference on Electronic Circuits and Systems, Morocco*, (2007), pp. 111-114. 2007.
- [23] Chandan Kumar Jha, Reshu Jain, Literature Survey on Various Outdoor Propagation Model for Fixed Wireless Network, *International Journal of Science and Research (IJSR)*, Vol. 3 Issue 8, August 2014.
- [24] Simic I. Igor, Stanic I., and Zrnic B., "Minimax LS Algorithm for Automatic Propagation Model Tuning," *Proceeding of the 9th Telecommunications Forum (TELFOR 2001)*, Belgrade, Serbia, 2001.
- [25] M. Aref and A. Sikora, "Free space range measurements with Semtech Lora™ technology," *2014 2nd International Symposium on Wireless Systems within the Conferences on Intelligent Data Acquisition and Advanced Computing Systems*, Offenburg, 2014, pp. 19-23. doi: 10.1109/IDAACS-SWS.2014.6954616
- [26] P. Jörke, S. Böcker, F. Liedmann and C. Wietfeld, "Urban channel models for smart city IoT-networks based on empirical measurements of LoRa-links at 433 and 868 MHz," *2017 IEEE 28th Annual International Symposium on Personal, Indoor, and Mobile Radio Communications (PIMRC)*, Montreal, QC, 2017, pp. 1-6. doi: 10.1109/PIMRC.2017.8292708
- [27] V. S. Abhayawardhana, I. J. Wassell, D. Crosby, M. P. Sellars and M. G. Brown, "Comparison of empirical propagation path loss models for fixed wireless access systems," *2005 IEEE 61st Vehicular Technology Conference*, Stockholm, 2005, pp. 73-77 Vol. 1., doi: 10.1109/VETECS.2005.1543252

# Qualitative Research on Software Engineering Industrial Practice: Lessons Learned from Previous Studies

Ž. Stojanov, J. Stojanov and D. Dobrilović

University of Novi Sad, Technical Faculty "Mihajlo Pupin", Zrenjanin, Serbia  
zeljko.stojanov@uns.ac.rs, jelena.stojanov@uns.ac.rs, dalibor.dobrilovic@uns.ac.rs

**Abstract - Inquiry of software engineering industrial practice requires skilled researchers that know enough about the field practice and research methods. A deeper and more complete understanding of the practice can be achieved by using qualitative research methods, which make it possible to determine how and why something happened in the practice. However, implementation of qualitative methods is not so easy for researchers with engineering background, and requires learning from seminal books and from own experience. Common way of learning from own experience is by analyzing past studies or projects, and identify lessons learned. This paper presents lessons learned from four qualitative studies conducted in software industry in last ten years. Based on the identified lessons, potential improvements for further qualitative studies are proposed. Further research directions based on described lessons learned are also outlined.**

## I. INTRODUCTION

Qualitative research methods originate in social science where they are used to assist in understanding people and their actions in specific context [1]. They are regularly used in education, psychology, social work, health science and management for over 50 years. The popularity of qualitative methods is result of their ability to adequately understand, describe and explain complex phenomena related to people behavior. According to Silverman [2], "the particular strength of qualitative research, for both researchers and practitioners, is its ability to focus on actual practice in situ, looking at how organizations are routinely enacted". Qualitative research is focused on qualities of an entity and on processes, and meanings that cannot be measured and presented with quantitative terms such as amount, intensity and frequency [3]. This approach assumes complete involvement of researcher in an observed context, which results with interpreted or constructed view of reality.

Qualitative research is usually seen as a broad approach for studying social phenomena by using multiple methods of inquiry. According to Marshall and Rossman [1], the main characteristics of qualitative research are: it is placed in a real naturalistic world, it uses multiple interactive and humanistic methods, it is focused on specific context, it is emergent, rather than preconfigured or prescribed, and it is interpretative.

People give meaning to their experience, circumstances and situations, objects and actions in their living context, which is in the focus of qualitative research [4]. Therefore, the main aim of qualitative researcher is to extract meaning from data collected in observed context. Data in qualitative research are text and words, rather than numbers. Qualitative research can be treated as intellectual and creative, but also rigorous craft that is usually learned and improved during use in the practice. The key elements of qualitative research are inductive reasoning and inference, which enable developing propositions, hypotheses, and theories from empirical evidence from the real context [5].

Qualitative studies are based on variety of empirical materials such as case studies, personal experience, introspection, life story, interview, observational texts, historical texts, and interactional and visual texts [3]. These materials describe individual behavior or meaning people give to activities and objects in an observed context. Transformation of this material in a single written text, or a collection of texts through transcription enables researchers to perform data analysis activities [6]. Transcription of raw empirical data and analysis of transcribed text should preserve original perspectives of people involved in a qualitative study.

Qualitative research use one or more different approaches, the choice of which depends on the research objectives. Miles et al. [7] described several different qualitative research genres or approaches used in qualitative studies. These approaches range from traditional ones such as ethnography, grounded theory, phenomenology, case study, thematic analysis, and content analysis to more progressive approaches such as poetic inquiry, narrative inquiry, ethno-drama or auto-ethnography. Regardless of the used approach the common data analysis techniques are [7]: assigning codes or themes to text segments, sorting and shifting through coded material to identify similar phrases and common sequences, isolating patterns, commonalities and differences and use them in the next wave of data collection, noting reflections and remarks in journals or memos, incrementally elaborating a set of propositions and generalizations that cover empirical material, comparing and discussing study findings with existing body of knowledge.

Software engineering researchers and practitioners adopted qualitative research methods in 1990s when it was recognized the importance of human and organizational factors (non-technical issues) for progress of software engineering practice [8]. Qualitative empirical studies have been organized to inquiry non-technical issues in software engineering practice, as well as intersections between technical and non-technical issues. Software engineering practice assumes people that solve real problems in real situations, which mean that it is necessary to conduct studies in the real settings by using the most appropriate methods for collecting field data [9]. Majority of these techniques are classified as first degree methods that involve active participation of software engineers, such as: interviews, practice observation, brainstorming, questionnaires, action research, etc. These techniques have origin in social science. However, since qualitative methods are borrowed from social sciences, it is necessary to understand them (origins, epistemology and ontology) before implementing them in software engineering empirical research on practice [10]. Successful implementation assumes selecting the most suitable methods, learning from relevant literature, and adapting methods to the specifics of the practice. In addition, the main objects of data analysis in qualitative research are words and unstructured text, which assumes that researchers should understand interpretation of words and construct reality from them [11].

Learning from experience and projects is important for industrial practice, but also for academic research which should be tightly related to real problems in the practice [12]. Lessons learned from research projects should help researchers from academia to improve their work by proposing more profound research objectives [13], which will lead to conducting more relevant research for software industry. This is especially important for researchers with engineering background that use qualitative methods because methods origin in social science and requires additional endeavor to learn and implement them in engineering practice.

Wide use of qualitative research methods for inquiring software engineering practice leads to the need to systematize knowledge about previous projects and draw lessons for structuring further research and introducing subjects on empirical research in software engineering education. Based on these observations, the objective of this paper is to identify and elaborate lessons learned from four qualitative studies conducted within the project dedicated to process improvement in software industry, and to propose recommendations for further qualitative studies. The paper is structured as follows. The next section presents related work on lessons learned importance for software engineering research and practice. The third section shortly outlines for qualitative studies, followed with discussion of lessons learned. The last section contains concluding remarks and further research directions.

## II. RELATED WORK

Learning as a social activity embedded in a given context naturally occurs in organizations which tend to improve their current practice based on experiences from

past projects [14]. Learning between projects depend on project types, teams that work on projects, and social interaction within organization in which projects are organized. According to Holzmann [15], knowledge transfer, which is essential for learning in organizations, occurs at different levels: team, project, organization, and the industry. However, lessons learned have not been commonly used, which prevents or puts constraints at achieving any benefits from lessons learned [16], or simply prevents learning from mistakes [17] and failures [18].

Due to increased complexity of software engineering practice, which is performed in variety of socio-technical settings, and recognition of the importance of empirical research for the practice, discussion of lessons learned gain attention in software engineering research community. Based on results from an empirical study on factors contributing to success of software projects, Mohagheghi and Jorgensen [19] suggested that lessons learned are tightly connected to success factors and helps in overcoming challenges. Some of the studies on lessons learned in software engineering are presented below in this section.

Global requirements engineering brings several challenges to software professionals, teams and organizations, which requires practical advises to effectively manage them [20]. Identified challenges are: knowledge acquisition and sharing, aligning processes and tools, and effective communication and coordination. For outlined challenges, Damian proposed the following advises based on lessons from the practice [20]: defining a clear organization structure with communicating responsibilities, establishing peer-to-peer links at all management, project, and team levels across all distributed sites, synchronizing inter-organizational processes with frequent iterations and deliveries, establishing cultural liaisons, maintaining open communication lines, and frequent informing and monitoring of progress. The author also calls for other researchers and practitioners to report their experience and lessons from the practice.

Adolph et al. [21] presented lessons learned from grounded theory study aimed at understanding how software methods are used in software development. The authors clearly stated motivation for inquiring the use of methods in software development (developers do not believe that methods address their needs in the practice), outlined essentials of grounded theory methodology, shortly presented their study, and summarized their lessons from the study. Lessons relates to using specific version of grounded theory, basic concepts of grounded theory such as constant comparative method and the core category, sampling method and ensuring that developed theory is real grounded theory.

Vanya et al. [22] described the lessons learned on effective support to software architects aimed at improving their system decomposition. The support process had been applied to a large industrial software system. Lessons learned were extracted as incidents from events log during the execution of case studies. The lessons are grouped in three categories: (1) Knowing the

process (Know thy process, Involve both architects and developers), (2) Knowing the data (Set the right abstraction level, Processing the raw data takes time), and (3) Frequent feedback loops with architects and developers (Reduce data early, Architects need to understand the computations, Multiple simple measures are better than a single complex measure, Architects' concerns vary, Couplings should be traceable to the raw data, Do not rely on the developers' first impressions).

Member checking is a technique used in qualitative research for increasing accuracy and validity of research findings by letting participants to reflect on researchers' interpretations and research findings [23]. However, only a small number of qualitative studies in software engineering reported use of member checking [24]. Based on literature review and personal experience from industrial case study Santos et al. [24] discussed the following lessons learned in member checking process: results validation, self-reflection of researchers, feedback to participants, self-reflection of participants, strength of evidence, different perspectives, and reaching closure.

### III. LEARNING FROM PREVIOUS STUDIES

This section presents a short overview of qualitative research studies conducted in last nine years as a part of the project "The development of software tools for business process analysis and improvement" funded by Ministry of Education, Science and Technological Development, Republic of Serbia. The research includes software engineering areas such as human actor in software requirements engineering, software change request process, process assessment and improvement in software maintenance, and knowledge management related to software maintenance. Summary of lessons learned during project implementation is presented.

The idea of using qualitative methods for inquiring software engineering practice arose during the first author's work on PhD dissertation, where qualitative methods were used for analyzing students experiences with software maintenance services in computer laboratory [25][26]. Qualitative methods were adopted due to their suitability for inquiring human, social and organizational issues in software engineering practice [27][28], which was recognized during preparation of the project.

#### A. Review of previous studies

The first qualitative study with participants from software industry was organized to identify characteristics of software change request process in very small software companies [29][30]. The study was organized as a part of the first author PhD research, but results were also used for structuring the project aimed at assessing and improving business processes (see the initial part of this section). Coding proposed in constructivist grounded theory [31] was used for the analysis of collected data. The core category is *Software change request process*, and its properties are identified characteristics of change request process in practice. The findings of this study indicate that there is a need for assessing and improving software maintenance practice in small software

companies, which was used as one of the ideas for proposing the project aimed at assessing and improving business processes (software change request process is one of the most important business processes in software companies).

The next qualitative study was software maintenance process assessment study organized in a local micro software company. The study was implemented within the project "The development of software tools for business process analysis and improvement". Software maintenance assessment was the first phase in the project, aimed at identifying potential improvements of software maintenance practice in the selected software company. Process assessment is based on the real state in the company, active participation of the company employees, frequent feedback during the assessment, and variety of data sources with both qualitative and quantitative data [32]. The main data analysis technique used for identifying process improvement proposals was inductive thematic analysis [33]. Improvement proposals were identified as the main themes in unstructured text collected by using interviews with programmers, practice observation and transcribed records of working sessions in the company. Four improvement proposals were identified, while only one was implemented in the company and documented as a technical solution.

Knowledge management activities naturally occur during software process assessment, because process assessment enables an organization to learn from the practice and systematize existing knowledge [34]. This led to organization of the third qualitative study aimed at identifying and systematizing knowledge in the selected company. Knowledge management activities were implemented in parallel with the process assessment activities, and later structured as a lightweight inductive method for knowledge identification and systematization [35]. Knowledge about software maintenance practice was organized as a thematic framework [36], which contains the themes organized in the following areas: human factor, organizational issues and business policy, and maintenance process. The same qualitative data used in software process assessment were used for this study, while inductive thematic analysis [37] was used for developing knowledge framework.

The last qualitative study in the project was organized to explore human factor issues in software requirements elicitation and specification activities. The study involved 14 software developers, from which data were collected by using semi-structured in-depth interviews. The participants work as software developers in indigenous software companies, foreign large software companies, or as freelancers. Data analysis was performed by using inductive thematic analysis method proposed by Braun and Clarke [37], while more detailed organization of identified themes was aided with thematic networks [38]. Data analysis enabled development of two thematic networks with findings of qualitative data analysis. The first thematic network contains software developers experience in problem solving activities during requirements elicitation and specification [39], while the second one contains developers' perceptions of soft skills that are necessary in software requirements activities [40].



### *B. Lessons learned*

Based on experience from described studies, we have learned several lessons on using qualitative research methods for inquiring social and human aspects of software engineering practice. These lessons are:

- There are dozens of methodologies and approaches in qualitative research, so it is important to be aware of them and their characteristics before selecting the most appropriate ones for the current study. Presented studies used grounded theory (the first study) and inductive thematic analysis (other three studies) because there are a lot of books and published studies describing them, which made it easier to learn and master them.
- It is important to select methods based on team experience and knowledge of research methods in order to facilitate study execution and to get valid findings. For example, since inductive thematic analysis is easier to implement than several other qualitative methods (e.g. grounded theory or ethnography), this method is selected for a study that involve a novice and inexperienced researcher [39][40].
- Full support of organizations participating in research is essential for success of research study and for validity of findings. This implies a complete commitment from management, which enables access to all necessary resources - people, documents, digital repositories, etc. The most important is to get access to the most relevant people, processes, documents and other resources that will enable collecting the most usable data.
- Due to the interpretative nature of qualitative studies, validation of the findings by relevant people from organization is the best way to ensure validity of study findings. Validation of findings by management or the most experienced employees proved to be the best choice, since they are best versed in the practices and implemented processes.
- Inquiry of specific segments of practice in a real setting requires the use of different methods for collecting data, based on each specific case. The most common way for collecting data is by using semi-structured interviews, but focus groups, brainstorming sessions, practice observations or gathering relevant documents are also good choices. It is necessary to select the most suitable method for each practice segment (processes, people behavior or actions, people view of some interesting practice segments). In addition, when using multiple methods, it is important to apply them in a manner and order that provides access to the most relevant data that will contribute to construction of findings (for example, if it is determined that additional data need to be collected, the order in which the appropriate methods are applied is important).
- Mixing qualitative methods with quantitative methods [41][42] enables more comprehensive insight into software engineering practice, and this

assumes composing research team that is capable to use these diverse methods, and coordinating different data analysis threads done by different researchers. Quantitative methods were used as support data analysis activities in the second study for estimating maintenance effort [43] and ranking software maintenance processes [44].

Outlined lessons are important for learning from experience, and they make it possible to identify gaps in research and to look at potential improvements for future studies. Potential improvements for further qualitative studies are:

- Learning about philosophical stances that underpin specific qualitative methodologies in order to get better positioning of researchers towards empirical study and implement methodologies in consistent manner and with the best outcomes.
- Increase understanding of different qualitative methods for collecting and analyzing data before selecting the most suitable ones for particular cases and engaging researchers with appropriate experience for selected methods.
- Including in research team experts from different social science disciplines for better structuring and conducting research studies on specific people behavior (sociologists, psychologists, economists, etc).

As Swan stated [45], organizations that are engaged in several projects should develop practice of learning from experiences and lessons learned in previous projects. This statement can be applied in both industrial and academic settings. For academic research, lessons learned have twofold value. The first is use of lessons learned to improve future research projects, while the second one is use of lessons learned to improve teaching. The experience and lessons presented in this section are valuable for improving subjects' curricula in the fields of software engineering and information technology management.

### IV. CONCLUSIONS

Lessons learned are important tool for assessing experience from previous studies and projects, as well as for determining potential improvements for future projects. Reported lessons are of essential importance for researchers or practitioners that create them, but may be of interest to other especially for avoiding reported mistakes.

This paper presents a short overview of lessons learned after conducting four qualitative studies related to software engineering industrial practice. The main contribution of this paper is systematization of learned lessons, which form the basis that will be considered in planning future studies and improving curricula in software engineering and information technology management subjects.

Further work will be directed in the following direction. The first direction is organization of a systematic literature review of lessons learned as a segment of knowledge management practice in software

engineering. The second direction is extension of a research team with experts from social science disciplines for improving qualitative study design, findings and validity. The third research direction relates to defining the methods, processes and tools for transferring lessons learned from research projects to university education. And, the last direction relates to developing a method and a tool for systematizing lessons learned from previous projects.

#### ACKNOWLEDGMENT

Ministry of Education, Science and Technological Development, Republic of Serbia, supports this research under the project "The development of software tools for business process analysis and improvement", project number TR32044.

#### REFERENCES

- [1] C. Marshall, and G.B. Rossman, *Designing Qualitative Research* (5th Edition). Thousand Oaks, CA, USA: SAGE Publications, 2011.
- [2] D. Silverman, "Qualitative research: meanings or practices?", *Information Systems Journal*, vol. 8, no. 1, pp. 3 - 20, 1998.
- [3] N.K. Denzin, and Y.S. Lincoln, "Introduction: The discipline and practice of qualitative research". In *The SAGE Handbook of Qualitative Research* (3rd Edition), N. K. Denzin and Y.S. Lincoln (editors), pp. 1-32. Thousand Oaks, CA, USA: SAGE Publications, 2005.
- [4] S.N. Hesse-Biber, and P. Leavy, *The Practice of Qualitative Research* (2nd Edition). Thousand Oaks, CA, USA: SAGE Publications, 2011.
- [5] N.J. Fox, "Induction". In *The SAGE Encyclopedia of Qualitative Research Methods*, L.M. Given (editor), . pp. 429-430. Thousand Oaks, CA, USA: SAGE Publications, 2008.
- [6] D.E. Polkinghorne, "Language and Meaning: Data Collection in Qualitative Research", *Journal of Counseling Psychology*, vol. 52, no. 2, pp. 137-145, 2005.
- [7] M.B. Miles, A.M. Huberman, and J. Saldaña. *Qualitative Data Analysis: A Methods Sourcebook* (3rd Edition). Thousand Oaks, CA, USA: SAGE Publications. 2013.
- [8] T. Dybå, R. Prikladnicki, K. Rönkkö, C. Seaman, and J. Sillito, "Qualitative research in software engineering", *Empirical Software Engineering*, vol. 16, no. 4, pp. 425-429, 2011.
- [9] T.C. Lethbridge, S.E. Sim, and J. Singer, "Studying Software Engineers: Data Collection Techniques for Software Field Studies", *Empirical Software Engineering*, vol. 10, no. 3, pp. 311-341, 2005.
- [10] S.E. Sim, J. Singer, and M-A. Storey, "Beg, Borrow, or Steal: Using Multidisciplinary Approaches in Empirical Software Engineering Research", *Empirical Software Engineering*, vol. 6, no. 1, pp. 85-93, 2001.
- [11] K. Rönkkö, "Interpretation, interaction and reality construction in software engineering: An explanatory model", *Information and Software Technology*, vol. 49, no. 6, pp. 682-693, 2007.
- [12] V. Garousi, K. Petersen, and B. Ozkan, "Challenges and best practices in industry-academia collaborations in software engineering: A systematic literature review", *Information and Software Technology*, vol. 79, pp. 106-127, 2016.
- [13] L.C. Briand, "Useful software engineering research - leading a double-agent life", In *Proceedings of the 27th IEEE International Conference on Software Maintenance (ICSM)*, pp. 2-2. Williamsburg, VI, USA, 2011.
- [14] A. Hartmann, and A. Dorée, "Learning between projects: More than sending messages in bottles", *International Journal of Project Management*, vol. 33, no. 2, pp. 341-351, 2015.
- [15] V. Holzmann, "A meta-analysis of brokering knowledge in project management", *International Journal of Project Management*, vol. 31, no. 1, pp. 2-13, 2013.
- [16] L. Rhodes, and R. Dawson, "Lessons Learned from Lessons Learned", *Knowledge and Process Management*, vol. 20, no. 3, pp. 154-160, 2013.
- [17] K. Jugdev, "Learning from Lessons Learned: Project Management Research Program", *American Journal of Economics and Business Administration*, vol. 4, no. 1, pp. 13-22, 2012.
- [18] S. Ellis, and I. Davidi, "After-Event Reviews: Drawing Lessons From Successful and Failed Experience" *Journal of Applied Psychology*, vol. 90, no. 5, pp. 857-871, 2005.
- [19] P. Mohagheghi, and M. Jorgensen, "What Contributes to the Success of IT Projects? Success Factors, Challenges and Lessons Learned from an Empirical Study of Software Projects in the Norwegian Public Sector", In *proceedings of the IEEE/ACM 39th International Conference on Software Engineering Companion*, pp. 371-373. Buenos Aires, Argentina, 2017.
- [20] D. Damian, "Stakeholders in Global Requirements Engineering: Lessons Learned from Practice", *IEEE Software*, vol. 24, no. 2, pp. 21-27, 2007.
- [21] S. Adolph, W. Hall, and P. Kruchten, "A methodological leg to stand on: lessons learned using grounded theory to study software development", In *Proceedings of the 2008 conference of the center for advanced studies on collaborative research: meeting of minds (CASCON '08)*, pp. 166-178. Richmond Hill, Ontario, Canada, 2008.
- [22] A. Vanya, S. Klusener, R. Premraj, and H. van Vliet, "Supporting software architects to improve their software system's decomposition – lessons learned", *Journal of Software: Evolution and Process*, vol. 25, no. 3, pp. 219-232, 2013.
- [23] V.N. Anney, "Ensuring the Quality of the Findings of Qualitative Research: Looking at Trustworthiness Criteria", *Journal of Emerging Trends in Educational Research and Policy Studies*, vol. 5, no. 2, pp. 272-281, 2014.
- [24] R.E.S. Santos, C.V.C. Magalhães, and F.Q.B. da Silva, "Member checking in software engineering research: lessons learned from an industrial case study", In *Proceedings of the 11th ACM/IEEE International Symposium on Empirical Software Engineering and Measurement (ESEM '17)*, pp.187-192. Markham, Ontario, Canada, 2017.
- [25] Z. Stojanov, D. Dobrilovic and B. Perisic, "Integrating software change request services into virtual laboratory environment: Empirical evaluation", *Computer Applications in Engineering Education*, vol. 22, no. 1, pp. 63-71, 2014.
- [26] Z. Stojanov and D. Dobrilovic, "Qualitative Evaluation of Software Maintenance Services Integrated in a Virtual Learning Environment", *International Journal of Engineering Education*, vol. 32, no. 2(A), pp. 790-803. 2016.
- [27] C. B. Seaman, "Qualitative methods in empirical studies of software engineering", *IEEE Transactions on Software Engineering*, vol. 25, no. 4, pp.557-572, 1999.
- [28] Y. Dittrich, M. John, J. Singer, and B. Tessem, "For the Special issue on Qualitative Software Engineering Research", *Information and Software Technology*, vol. 49, no. 6, pp. 531-539, 2007.
- [29] Z. Stojanov, D. Dobrilovic, and V. Jevtic, "Identifying properties of software change request process: Qualitative investigation in very small software companies", In *Proceedings of the 9th IEEE International Symposium on Intelligent Systems and Informatics (SYSI 2011)*, pp. 47-52. Subotica, Serbia. 2011.
- [30] Z. Stojanov, "Using Qualitative Research to Explore Automation Level of Software Change Request Process: A Study on Very Small Software Companies", *Scientific Bulletin of The "Politehnica" University of Timișoara, Transactions on Automatic Control and Computer Science*, vol. 57, no. 1, pp. 31-40, 2012.
- [31] K. Charmaz, *Constructing grounded theory: A practical guide through qualitative analysis*, (1st edition). London, UK: SAGE Publications 2006.
- [32] Z. Stojanov, A. Zarkov, and I. Berkovic, "Lightweight method for Maintenance Process Assessment based on Frequent Feedback - LMPAF2", Technical report. Technical faculty "Mihajlo Pupin" Zrenjanin, University of Novi Sad, Serbia. 2014. [in Serbian]
- [33] Z. Stojanov, and J. Stojanov, "Exploring software maintenance process characteristics by using inductive thematic analysis", In

**International conference on Applied Internet and Information Technologies  
October 3-4, 2019, Zrenjanin, Republic of Serbia**

---

- Proceedings of the 6th International Conference on Applied Internet and Information Technologies (AIIT2016), pp. 9-17. Bitola, Macedonia. 2016.
- [34] Z. Stojanov, J. Stojanov, and D. Dobrilovic, "Knowledge Discovery and Systematization through Thematic Analysis in Software Process Assessment Project", In proceedings of the IEEE 13th International Symposium on Intelligent Systems and Informatics (SISY 2015), pp. 25-30. Subotica, Serbia. 2015.
- [35] Z. Stojanov, D. Dobrilovic, and A. Zarkov, "Lightweight inductive method for Knowledge Identification and Systematization - LIM4KIS". Technical report. Technical faculty "Mihajlo Pupin" Zrenjanin, University of Novi Sad, Serbia. 2015. [in Serbian]
- [36] Z. Stojanov (2019) "Thematic knowledge framework on human factor in software maintenance practice: A study in a micro software company", *Journal of Software Engineering & Intelligent Systems*, vol. 4, no. 1, pp. 41-57. 2019.
- [37] V. Braun, and V. Clarke, "Using thematic analysis in psychology". *Qualitative Research in Psychology*, vol. 3, no. 2, pp. 77-101, 2006.
- [38] J. Attride-Stirling, "Thematic networks: an analytic tool for qualitative research", *Qualitative Research*, vol. 1, no. 3, pp. 385-405, 2002.
- [39] T. Zoric, and Z. Stojanov, "Problem solving in software requirements elicitation and specification: Preliminary results from a qualitative study". In Proceedings of the 7th International conference on Applied Internet and Information Technologies (AIIT2017), pp. 258-266. Zrenjanin, Serbia. 2017.
- [40] T. Zoric, and Z. Stojanov, Software developers' perceptions of soft skills in software requirements engineering. *Journal of Engineering Management and Competitiveness (JEMC)*, vol. 8, no. 1, pp. 54-64. 2018.
- [41] A. Bryman, "Integrating quantitative and qualitative research: how is it done?", *Qualitative Research*, vol. 6, no. 1, pp. 97-113, 2006.
- [42] A. Tashakkori, and Charles Teddlie, *SAGE Handbook of Mixed Methods in Social & Behavioral Research (2nd Edition)*. Thousand Oaks, CA, USA: SAGE Publications. 2010.
- [43] Z. Stojanov, D. Dobrilovic, J. Stojanov, and V. Jevtic, "Estimating Software Maintenance Effort by Analyzing Historical Data in a Very Small Software Company", *Scientific Bulletin of The "Politehnica" University of Timișoara, Transactions on Automatic Control and Computer Science*, vol. 58, no. 2, pp. 131-138, 2013.
- [44] Z. Stojanov, V. Brtko, and D. Dobrilovic, "Ranking Software Maintenance Processes in a Small Software Company in the Context of Software Process Improvement", *Scientific Bulletin of The "Politehnica" University of Timișoara, Transactions on Automatic Control and Computer Science*, vol. 59, no. 2, pp. 183-192, 2014.
- [45] J. Swan, H. Scarbrough, and S. Newell, "Why don't (or do) organizations learn from projects?", *Management Learning*, vol. 41, no. 3, pp. 325-344, 2010.

# Machine Reinforcement Learning with OpenAI Gym

S. Simić\*, V. Brtka\*, V. Jovović\*\*, I. Berković\* and V. Ognjenović\*

\*University of Novi Sad, Technical Faculty “Mihajlo Pupin”, Zrenjanin, Republic of Serbia

\*\*American University of Malta, Malta

srdjansimic@gmail.com, vbrtka@tfzr.uns.ac.rs, vjovovic@columbiacollege.ca, berkovic@tfzr.uns.ac.rs,  
visnjao@tfzr.uns.ac.rs

**Abstract** - The paper investigates OpenAI Gym platform and its use in testing of machine learning strategies. Virtual inverted pendulum is chosen as a testing ground. Three different machine learning and one trivial nonmachine learning strategies are compared. This platform is useful for education as well as for production testing of algorithms that are not mission critical.

## I. INTRODUCTION

The topic that this paper covers is testing of artificial intelligence strategies. In order to have comparable results it is necessary to be able to repeat tests and capture results from different approaches and algorithms. OpenAI Gym is a platform dedicated for reinforcement learning research. It is created by OpenAI, a company that was founded by Elon Musk, Sam Altman and other investors with the mission to ensure that AGI (artificial general intelligence) benefits all of humanity[1]. Currently there are more than 900 environments that can be chosen for a testing ground. Some are simple, but some are highly sophisticated and complex, like the 3D spider model that can be thought how to walk and how to interact with its environment as show in Fig. 1.

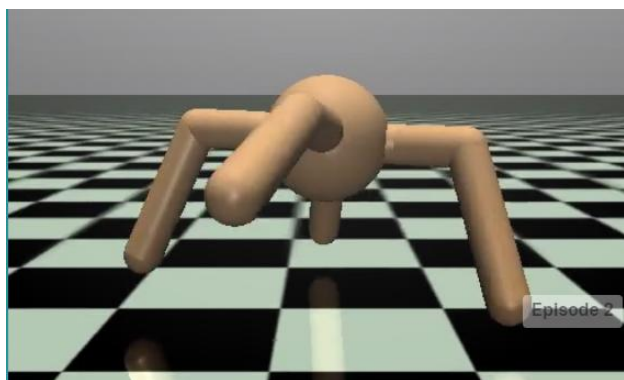

Figure 1.3D spider model

### A. Reinforcement learning

Reinforcement learning (RL) is an area of artificial intelligence (AI), strictly speaking, of machine learning. A simple explanation how a reinforcement learning algorithm work is the following. There are two participants, one is an agent that controls the testing object, and the other is an environment in which the agent

is operating. Agent (our software algorithm) receives form the environment information about the current state of our object, thenit chooses an action that is to be taken. In the end, the environment returns new state of the object with additional information about success of failure (reward). This interaction is shown in Fig. 2.

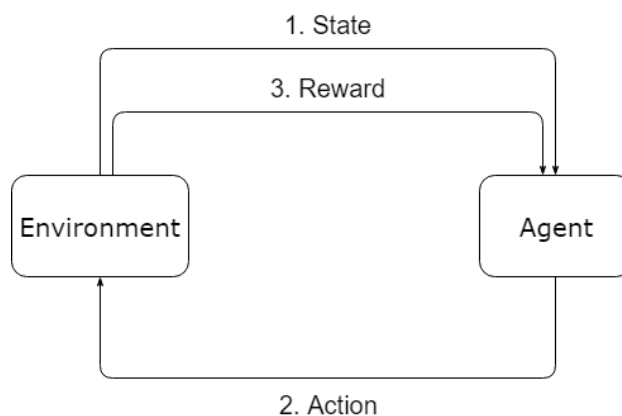

Figure 2.Reinforcement learning cycle

This simple cycle enables our algorithms to learn to play games without knowing a single rule, unlike the traditionalAI solutions for games like chess. In those instances, it is required first to teach the algorithm all the rules of the game. Then, using some algorithm for state space search process, the program would find the optimal next step to take (like A\* algorithm [2]). All that is needed for RL to work is to receive rewards (positive or negative when the action was not optimal).

## II. INVERTED PENDULUM

The environment that was chosen is inverted pendulum, or CartPole as it is called in OpenAI Gym. This is very common testing ground and it is made of a pole that has its center of mass above the pivot point that is on a moving cart. The cart can go left or right, and the pole can also fall to the left or to the right side. When the pole is in ideal vertical position, the system is in the state of unstable equilibrium. Even the smallest action will result in the pole falling. There are two ways to keep this from not happening. One is with the use of some sort of automated control (like PID controller[3]), and the other is to use a AI algorithm, specifically RL algorithm. For an

example, we can simulate this experiment by trying to balance a pencil on our palm.

Mathematical function that describes the movement of such a system is following and shown on Fig. 3:

$$\frac{d^2\theta}{dt^2} = \frac{g}{l} \sin(\theta) \quad (1)$$

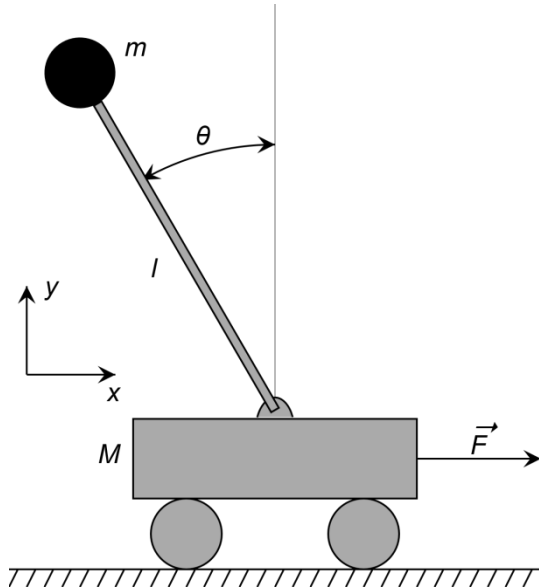

Figure 3. Inverted pendulum[4]

In (1)  $g$  is gravitational acceleration. From (1) we deduce that the angular acceleration is directly proportional to sinus of the pole angle. In OpenAI Gym, we can tell our agent only to move the cart to the left or right and using inertia, move the pole to the opposite direction, thus balancing it. There are several constraints:

- The cart is moving on ideally flat surface, without friction.
- Impact factor of the air is neglected.
- Friction does not exist in the pivot point where the pole is connected to the cart
- The action with which we can interact is only left and right and it is always with the same intensity and duration.
- The action must be taken in every step (there cannot be “do nothing” action).

There are game rules for every environment. For CartPole those are:

- For every successful step (that is the step in which the pole did not fall), the reward is one positive point.
- The game is won when the agent reaches 200 point.
- The no-return point, in which the environment assumes that there cannot be any further successful steps, is when the pole angle is more than 24 degrees.

- If the cart moves out from the screen, left or right, the game is stopped.

### III. STRATEGIES

A strategy is the main and most important part of the algorithm. It is used to choose, upon receiving state information from the environment, what action to take. In the example of inverted pendulum, state of environment includes following:

- Position of the cart on X axis.
- Speed of the cart along X axis.
- Pole angle.
- Angular speed of the pole.

This paper will show four different strategies.

#### A. Common sense

This is the simplest strategy. It is defined as follows: Push the cart to the same side to which the pole is falling. This behavior is logical, and it should yield good results.

#### B. Cross entropy loss function

This strategy creates binary classifier that is using binary cross-entropy loss function:

$$H(p, q) = -y \cdot \log(p) - (1 - y) \cdot \log(1 - p) \quad (2)$$

Using this loss function has some advantages, like:

- It is simple to use, does not require complex code, and for many smaller projects it is accurate enough.
- It has good speed of convergence for environments in which the rewards are often receive.

The idea behind this strategy is that we would generate random actions, then we would choose top good once and train the network with those examples by minimizing cross entropy loss function.

#### C. Gradient descent

This strategy uses gradient descent and TensorFlow[5] to find minimum of loss function. It is like the simple cross entropy strategy but does not need us to filter good or bad examples on which to train the algorithm.

#### D. Deep Q-Network

Deep Q-Network (DQN) strategy implementation relies on PyTorch AgentNet (PTAN), extension of PyTorch framework[6] and it is a variant of Q-Learning algorithm. This solution relies on replay buffer. That buffer is populated with previous examples and is used for training. There are several reasons for using this approach, and some of them are:

- Increase in programming speed. Developers can concentrate on building strategies, and not worry about noncritical code.
- Less bugs. Since the framework is tested, there are less chances for bugs.

This example of Q-Learning algorithm has one big advantage over the other solutions. It understands and implements the need to experiment in the initial phase of the training process, when the algorithm and the network are not yet trained enough. Later, it chooses experimentation less and exploitation more. This is done by using special selector function, epsilon greedy action selector[7]. The programmer does not need to implement the whole algorithm that will decide when to explore and when not to, that is all done in the framework.

#### IV. USING OPENAI GYM

In order to use OpenAI Gym platform, first it is needed to create the environment, then reset it, and finally create a loop in which the actions would be called. This is illustrated in the following code:

```
(1) import gym
(2) env = gym.make('CartPole-v0')
(3) state = env.reset()
(4) done = False
(5) while not done:
(6)     state, reward, done, _ = \
        env.step(env.action_space.sample())
```

Description of code per lines is as follows:

1. Importing Gym package.
2. Creating a new environment and assigning it to variable env.
3. Resetting environment, which means setting cart to the position that is near the center and the pole to the near vertical state.
4. Setting initial state of done variable so the while loop can be executed at least once.
5. Creating while loop.
6. Calling step function of environment, which takes a single parameter named action. That action in the case of CartPole can be either 0 or 1 – left or right). This function returns four values. The first, state, is the next state of the object, after action on action passed as a function parameter. The second value, reward, is the number of good points received in that step. For our example it is always one for each successful iteration of the while loop. The third value, done, is set to true when the iteration is not successful. The last value, which in our example is not received, is the info value for various informational purposes. Function sample that was passed as a parameter returns random action for our environment, which here is random number zero or one.

This is all that is needed for a simple use of OpenAI Gym. All other calculations are done in the framework, so programmer does not need to worry about them. Also, this

code is compatible with all types of environments, only the size of state and action differs. In CartPole scenario the state is an array of four values:

```
[Position, Speed, Angle, AngularSpeed]
```

What is left to be written is a scenario function that would decide what action is to be taken, based on the data in state variable.

#### V. TESTS

##### A. Common sense scenario

In this scenario the selector function is as follows:

```
def cs_scenario(state):
    pos, speed, angle, angle_sp = stanje
    if angle > 0:
        action = 1
    elif angle < 0:
        action = 0
    else:
        action = env.action_space.sample()
    return action
```

In our tests, after 1000 episodes, the maximum reward gathered was 115, and the average was 43.58. The distribution of rewards over episodes is as shown in Fig.4. On the x axis is the reward count and on the y axis is the number of episodes that reached that reward.

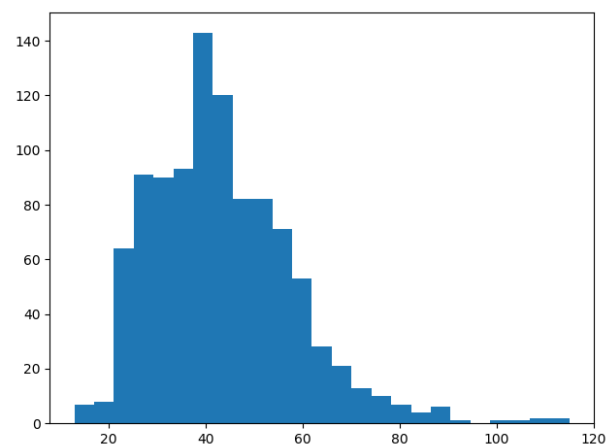

Figure 4. Histogram for common sense strategy

##### B. Cross entropy strategy

This test will use PyTorch package. The main difference between PyTorch and TensorFlow is in the way the neural network graph is created; for the first approach the graph is created dynamically and can be modified during execution and for the second one it is statically created before calculations are started. This means that any change requires to restart the whole process.

First the neural network is created using the function Sequential from nn class and it is assigned to variable net:

```
net = nn.Sequential(
    nn.Linear(4, 128),
```

```

nn.ReLU(),
nn.Linear(128, 128),
nn.ReLU(),
nn.Linear(128, 2)
)

```

The function Linear creates fully connected layer that has, in the second line, 4 inputs and 128 outputs. Then, rectified linear unit (ReLU) is used as an activation function. The next layer has 128 inputs and 128 outputs and ReLU activation function also. Finally, the last layer has 128 inputs and 2 outputs (one for each action). There is not activation function for the last layer since the framework adds automatically SoftMax activation function in the process of training. Later, when the network is used for exploitation, one SoftMax function must be used like in the code that follows:

```

sm = nn.Softmax(dim=1)
action = sm(net(state))

```

The algorithm for this strategy is the following:

1. Initialize network parameters using random values
2. Generate a batch of episodes and select only the good once. This can be done using percentile approach [8].
3. For network training input values set states of good episodes and for target output values set matching actions of those states.
4. Train network minimizing cross entropy loss function.
5. If the average value of rewards is not satisfactory, go to step 2.

Since this strategy will be much better it will reach goal and reward of 200 more often than the first one. This is the reason why it would make more sense to measure number of successful episode batcher and not the single episodes. In the following Fig.5, it is shown the number of batches of 100 episodes, where the average number of rewards is more than 195. On the x axis is the average number of episodes in the batch that has the reward of more than 195 and on the y axis is the number of those batches.

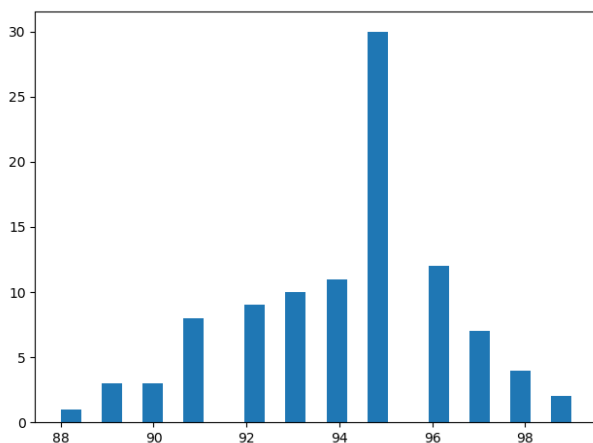

Figure 5. Success of batches of 100 episodes

The average reward for all episodes was 179.16.

### C. Gradient descent strategy

This test will use TensorFlow approach. The creation of neural network is similar as in the previous example, only different functions are used. As an activation function in the last layer, the Sigmoid function is used:

```

logits = tf.layers.dense(hiddenlayer2, 2)
output = tf.nn.sigmoid(logits)

```

The average reward for a test of 1000 episodes was 108.68 and the distribution was as shown in Fig. 6.

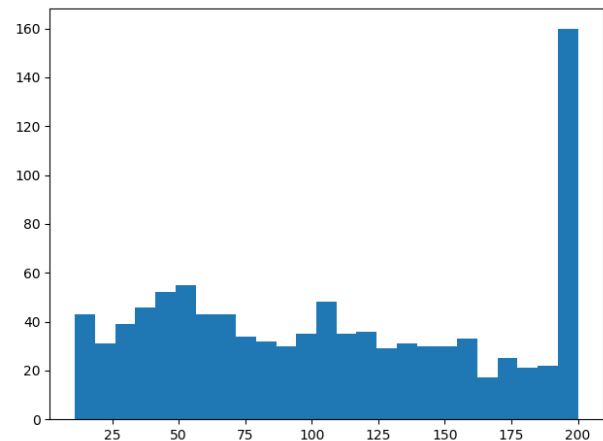

Figure 6. Histogram for gradient descent

### D. Deep Q-Network strategy

This test will use PTAN library. This library helps programmer by encapsulating the whole process of generation of training data in a single function. That function extracts good data and follow exploration-exploitation ratio mentioned earlier. All that is done in EpsilonGreedyActionSelector function that is used as follows:

```

selector =
ptan.actions.EpsilonGreedyActionSelector(epsilon=1.0)

agent = ptan.agent.DQNAgent(net, selector)

exp_source =
ptan.experience.ExperienceSourceFirstLast(env, agent, gamma=GAMMA)

replay_buffer =
ptan.experience.ExperienceReplayBuffer(exp_source, REPLAY_BUFFER)

```

Selector function, that is created in the first line is set to use epsilon greedy algorithm from value set to 1.0. That selector function is now assigned to an PTAN agent of type DQN (Deep QNet). After that, agent is connected with environment so we can create experience source (exp\_source) which is used to create a batch of data set in replay\_buffer. Calling function populate we now create training data:

```
replay_buffer.populate(1)
```

That experience is used for training of our neural network. The average reward in this test was 195.30 and the histogram is show in Fig. 7.

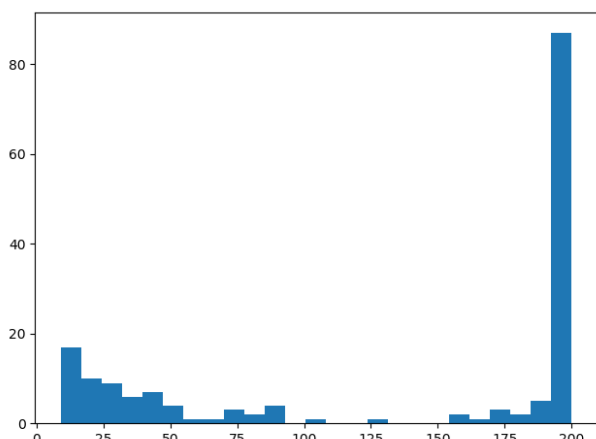

Figure 7. Histogram for Deep Q-Net strategy

## VI. COMPARISON

The results can be summarized in the following table:

Table 1 Testing results

<i>Strategy</i>	<i>Maximal reward reached...</i>	<i>... in iteration number</i>	<i>Average reward</i>
Common sense	115	957	43.58
Cross entropy	200	83	179.16
Gradient descent	200	100	108.68
Deep Q-Network	200	68	195.30

We can conclude from these results that some approaches are better, and some need more fine tuning. One fact that was discovered is very interesting. Common sense strategy did not yield full 200 reward, not in a single episode, even though it seems to be the most logical one. The reason for this can be found in physical restrictions of our environment. The friction is ignored, and there cannot be any difference between our actions. It is always the same, only difference is the direction. So, these limits put upon our algorithms new goals that cannot be solved with a simple push that is the result

of a single state of the environment. In order to perform better, a larger number of steps must be considered, and sometimes an illogical action has to be taken.

## VII. CONCLUSION

The paper describes how OpenAI Gym platform can be used for education and comparison of different artificial intelligence algorithms. We compared four different approaches, one that is static and always returns action that is in direct connection to the current state of the environment and three AI algorithms. Also, we showed that different frameworks can be successfully tested on OpenAI Gym platform. Furthermore, we learned that physical limits have to be considered since this platform is not indented for real life applications in robotics but is best suited for education and algorithm development.

## ACKNOWLEDGMENT

Ministry of Education, Science and Technological Development, Republic of Serbia financially supported this research, under the project number TR32044: "The development of software tools for business process analysis and improvement".

## REFERENCES

- [1] OpenAI, "OpenAI," [Online]. Available: <https://www.openai.com/>.
- [2] S. Simić, V. Brtka, V. Ognjenović, I. Berković and E. Brtka, "A\* Search Algorithm and Comparison of Heuristics," in *Conference of Information Technology and Development of Education - ITRO 2018*, Zrenjanin, 2018.
- [3] R. Sbresny, A. Getler, N. Felker and C. Frederickson, "Implementation of an Inverted Pendulum PID Control System Using a Stepper Motor," 2016.
- [4] Krishnavedala, "Inverted pendulum," [Online]. Available: [https://en.wikipedia.org/wiki/Inverted\\_pendulum](https://en.wikipedia.org/wiki/Inverted_pendulum).
- [5] A. Fandango, *Mastering TensorFlow 1.x*, Birmingham: Packt Publishing Ltd., 2018.
- [6] M. Lapan, „PyTorch Agent Net: reinforcement learning toolkit for pytorch,“ [Na mreži]. Available: <https://github.com/Shmuma/ptan>. [Poslednji pristup 06 2019].
- [7] M. Tokic, "Adaptive  $\epsilon$ -greedy Exploration in Reinforcement Learning Based on Value Differences," in *KI 2010: Advances in Artificial Intelligence*, Karlsruhe, 2010.
- [8] J. Frost, "Percentiles: Interpretations and Calculations," [Online]. Available: <https://statisticsbyjim.com/basics/percentiles/>.



# Data Science Tools Comparison

V. Ognjenovic\*, M. Jovanovic \*\*, V. Brtka\* and I. Berkovic\*

\*University of Novi Sad, Technical Faculty "Mihajlo Pupin", Zrenjanin, Serbia

\*\* University of Niš, Faculty of Electronic Engineering, Niš, Serbia

{visnjao, vbrtka, berkovic}@tfzr.uns.ac.rs, martin.jovanovic@elfak.ni.ac.rs

**Abstract** - The paper presents some basic tools for data analysis. The classification of the tools by type of programming knowledge is given. The some data science tools for the business users are compared by their extensions with basic data science tools for programmers. The possibilities of statistical data analysis, prediction and deep learning capabilities are explored.

## I. INTRODUCTION

In the past several years, the term data science became a buzzword. As written in [1] data science is a concept to unify statistics, data analysis, machine learning and their related methods in order to understand and analyze actual phenomena with data. More than that, data science became a part of business analytics, business intelligence and predictive analytics.

Some of the theories used in data science are:

- Statistics
- Linear Algebra
- Probability
- Econometrics
- Artificial Intelligence
- Game Theory

Appropriate software has been developed for such a large number of theories. Data science tools can be of two types: one for those who have programming knowledge and another for the business users.

This paper's structure consists of several sections. Tools for the business users and Tools for programmers give brief overview some popular tools. Section Extensions showing data science tools for business that having Python and R extensions. Final section is Comparison and conclusion.

## II. TOOLS FOR THE BUSINESS USERS

Some of the most popular data science tools for those who don't have programming knowledge are:

### A. Rapid Miner

RapidMiner is a data science software platform that provides an integrated environment for data preparation, machine learning, deep learning, text mining, and predictive analytics. Products are [2]:

- RapidMiner Studio - visual workflow designer for the entire analytics team,
- RapidMiner Auto Model - create predictive models using automated machine learning and data science best practices,
- RapidMiner Turbo Prep - blend, wrangle, and cleanse data with intuitive data preparation,
- RapidMiner Server - share and re-use predictive models, automate processes, and deploy models into production,
- RapidMiner Radoop - eliminate the complexity of data science on Hadoop and Spark.

RapidMiner is a Leader in the 2019 Gartner Magic Quadrant for Data Science and Machine Learning Platforms for the sixth year in a row [3].



Figure 1. Magic Quadrant for Data Science and Machine Learning Platforms (from [3])

### B. Alteryx

The software designed to make advanced analytics accessible is divided into four main products as a part of an analytics platform [4]:

- Alteryx Connect - discover, prioritize, and analyze all relevant information in organization,

- Alteryx Designer - logistic regressions and models with a full suite of advanced analytic tools,
- Alteryx Promote - developing, deploying, and managing real-time decision APIs,
- Alteryx Server - provides a gallery for users to share their work, a scheduling engine to automate data loads, version control and master data management features, and it even allows non Alteryx users to join the fun by enabling users to execute workflows and analytic apps directly from their web browser.

Alteryx was named a leader in the 2018 Magic Quadrant for Data Science and Machine Learning Platforms [3].

### C. Knime

Open source KNIME Analytics Platform for creating data science and commercial KNIME Server for productionizing data science:

- Knime Analytics Platform is a data analytics, reporting and integration platform, which integrates various components for machine learning and data mining through its modular data pipelining concept [5],
- Knime Server for productionizing data science brings complex data science to business analysts with the Knime WebPortal [6].

Knime analytics provides [7]:

- Classification and Predictive Modelling
- Regressions
- Clustering
- Scoring
- Optimization
- XGBoost
- Deep Learning
- Active Learning
- Time Series
- Statistics
- H2O Machine Learning
- Preprocessing
- PMML
- Meta Learning

### D. IBM SPSS

The IBM SPSS software platform offers advanced statistical analysis, a vast library of machine-learning algorithms, text analysis, open-source extensibility, integration with big data and deployment into applications [8]:

- IBM SPSS Statistics - the world's leading statistical software, designed to solve business and research problems,
- IBM SPSS Modeler - a graphical data science and predictive analytics platform,
- IBM SPSS Collaboration and Deployment Services - enables the deployment and sharing of predictive analytics across the enterprise,
- IBM SPSS Analytic Server - enables IBM SPSS Modeler to use big data as a source for predictive modeling,
- IBM SPSS Predictive Analytics Enterprise - features descriptive and predictive analytics, data preparation and automation, and it provides analytics for structured and unstructured data from any source,
- IBM SPSS Amos - a powerful structural equation modeling software helping support your research and theories by extending standard multivariate analysis methods, including regression, factor analysis, correlation, and analysis of variance.

### E. Summary

Based on [2] - [8], table 1 presents the capabilities of the previous software:

TABLE I. SUMMARY

Software	Software capabilities		
	<i>Statistical data analysis</i>	<i>Prediction</i>	<i>Deep learning</i>
RapidMiner	enabled	enabled	enabled
Alteryx	enabled	enabled	partially enabled
KNIME	enabled	enabled	enabled
IBM SPSS	enabled	enabled	partially enabled
	<b>enabled</b>	<b>enabled</b>	<b>partially enabled</b>

## III. TOOLS FOR PROGRAMMERS

Some of the most popular data science tools for those who have programming knowledge are:

### A. Python

The most popular and easy to use tools for data analytics is Python. According to the Stack Overflow survey of 2018, Python is the most popular programming language in the world and is also known as the most suitable language for data science tools and applications. It supports structured programming, object-oriented programming as well as the functional programming language and others [9]

The Python programming language is well suited for machine learning. It has a huge array of well supported packages that make coding simpler and reduce development time. Machine learning, deep learning and artificial intelligence are extremely well catered for by

several Python packages: scikit-learn, TensorFlow, Keras, PyTorch [10].

## B. R

R is a language and environment for statistical computing and graphics. It provides a wide variety of statistical (linear and nonlinear modelling, classical statistical tests, time-series analysis, classification, clustering) and graphical techniques, and is highly extensible. R includes:

- an effective data handling and storage facility,
- a suite of operators for calculations on arrays, in particular matrices,
- a large, coherent, integrated collection of intermediate tools for data analysis,
- graphical facilities for data analysis and display either on-screen or on hardcopy, and
- a well-developed, simple and effective programming language which includes conditionals, loops, user-defined recursive functions and input and output facilities [11].

## C. Excel

With a variety of powerful features such as form creation, PivotTable, VBA, etc. Excel's system for not big data is so large that no analytics tool can surpass it. But, working with really big data in Excel is not possible.

PyXLL, the Python Excel Add-In embeds Python in Excel, allowing us to extend Excel with Python and work with big data. PyXLL makes Python a productive, flexible back-end for Excel worksheets, and allows uses the familiar Excel user interface to interact with other parts of information infrastructure [12]:

Likewise, tools BERT is designed to support running R functions from Excel spreadsheet cells. In Excel terms, it's for writing User-Defined Functions in R [13].

## IV. EXTENSIONS

Data science tools for business have Python and R extensions:

### A. Tools for the business users - Python

RapidMiner – Python. The Python scripting extension integrates RapidMiner with the Python and allows embedding Python code into RapidMiner processes. [14]

Alteryx – Python. With the 2018.3 version of Alteryx came the Python Jupyter Notebook Tool, which means that Jupyter notebooks are now being used directly in Alteryx. This integration allows to seamlessly running Python code as a part of Alteryx workflow [15].

Knime – Python. The KNIME Python Integration makes use of an existing Python, which is installed alongside KNIME Analytics Platform. As the KNIME Python Integration depends on certain Python packages, the Python installation needs to have these packages installed [16]. Figure 2 presents KNIME Python

Preferences page. Here can be set the path to the executable script that launches Python environment [17].

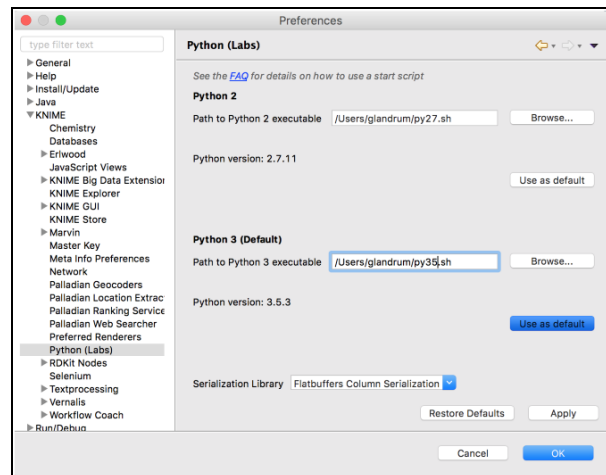

Figure 2. Setting up the KNIME Python extension

IBM SPSS – Python. The IBM SPSS Statistics - Integration Plug-in for Python is included with IBM SPSS Statistics - Essentials for Python, which is installed by default with IBM SPSS Statistics product. Essentials for Python also includes Python version 2.7 on all supported operating systems and a set of extension commands that are implemented in Python that provide capabilities beyond what is available with built-in SPSS Statistics procedures [18].

### B. Tools for the business users - R

RapidMiner – R. RapidMiner and R - are connected. Arbitrary R models and scripts can be directly integrated into the RapidMiner analysis processes. The R perspective offers the known R console together with the great plotting facilities of R. All variables and R scripts can be organized in the RapidMiner Repository [19]. The figure 3 shows the integration of RapidMiner and R [20].

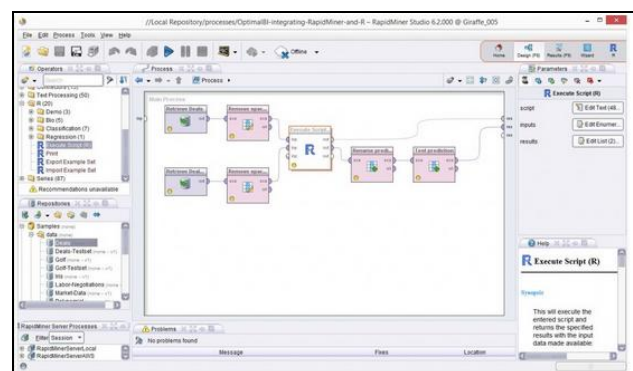

Figure 3. Integrated RapidMiner and R (from [20])

Alteryx – R. Alteryx Analytics provides deep integration of R statistics and predictive language, offering a way to bridge the worlds of ease of use and sophisticated predictive analytics [21].

Knime – R. there are many different types of data integration software Knime – R. The R-server allows to other software to execute R-code. Knime-scripting

includes scripting extensions for KNIME to integrate R scripts [22].

IBM SPSS – R. IBM SPSS Statistics - Essentials for R includes the IBM SPSS Statistics - Integration Plug-in for R and a set of extension commands that are implemented in R that provide capabilities beyond what is available with built-in SPSS Statistics procedures [18].

## V. COMPARISON AND CONCLUSION

Data science software for business users and data science software for developers is closely linked. It is shown in the paper that connectivity is greatest in the field of statistical data analysis and prediction. The deep learning area is largely reserved for data science software for developers.

In praxis, companies that currently invest in data science are more profitable than their competitors. It's not just about statistical data analysis, but about predicting new opportunities based on data in the systems. This is why basic data science tools for business have Python and R extensions.

## ACKNOWLEDGMENT

Ministry of Education, Science and Technological Development, Republic of Serbia financially supported this research, under the project number TR32044: "The development of software tools for business process analysis and improvement".

## REFERENCES

- [1] Ch. Hayashi, "What is Data Science? Fundamental Concepts and a Heuristic Example", Data Science, Classification, and Related Methods. Studies in Classification, Data Analysis, and Knowledge Organization. Springer Japan. pp. 40–51, 1998.
- [2] RapidMiner: Lightning Fast Data Science Platform for Teams, <https://rapidminer.com/>
- [3] C. Idoine, P. Krensky, E. Brethenoux, A. Linden, "Magic Quadrant for Data Science and Machine Learning Platforms", <https://www.gartner.com/doc/reprints?id=1-65WC001&ct=190128&st=sb>, 2019.
- [4] Alteryx: Self-Service Data Analytics Platform, <https://www.alteryx.com>
- [5] Knime Analytics Platform, <https://www.knime.com/knime-analytics-platform>
- [6] Knime Server, <https://www.knime.com/knime-server>
- [7] Analytics | KNIME, <https://www.knime.com/nodeguide/analytics>
- [8] IBM SPSS software, <https://www.ibm.com › spss-statistics-software>
- [9] How Python Is Used In Data Science?, <https://irishtechnews.ie/how-python-is-used-in-data-science/amp/>
- [10] An online community for showcasing R & Python tutorials, <https://datascienceplus.com>
- [11] The R Project for Statistical Computing, <https://www.r-project.org>
- [12] PyXLL User Guide, <https://www.pyxll.com/docs/pyxll.pdf>
- [13] BERT | Basic Excel R Toolkit, <https://bert-toolkit.com>
- [14] RapidMiner Marketplace, <https://marketplace.rapidminer.com>
- [15] The Python Tool In Alteryx, Inviso, <https://inviso.dk/blog/post/the-python-tool-in-alteryx>
- [16] KNIME Python Integration Installation Guide, [https://docs.knime.com/2018-12/python\\_installation\\_guide/index.html](https://docs.knime.com/2018-12/python_installation_guide/index.html)
- [17] Setting up the KNIME Python extension. Revisited for Python 3.0 and 2.0, <https://www.knime.com/blog/setting-up-the-knime-python-extension-revisited-for-python-30-and-20>
- [18] How to Get Integration Plug-Ins – IBM, [https://www.ibm.com/support/knowledgecenter/en/SSLVMB\\_22.0.0/com.ibm.spss.statistics.help/spss/base/faq\\_plugins.htm](https://www.ibm.com/support/knowledgecenter/en/SSLVMB_22.0.0/com.ibm.spss.statistics.help/spss/base/faq_plugins.htm)
- [19] RapidMiner Marketplace, <https://marketplace.rapidminer.com>
- [20] When one tool is not enough: integrating RapidMiner and R, <https://optimalbi.com/blog/2015/03/05/when-one-tool-is-not-enough-integrating-rapidminer-and-r/>
- [21] Big Data Analytics with R | Alteryx, <https://www.alteryx.com/big-data-analytics-r>
- [22] Connecting to R Server - Scripting - KNIME Community Forum, <https://forum.knime.com/t/connecting-to-r-server/13347>

# Security Issues in Applying Web Services within Business Applications: a Case Study

L.Perišić, Lj. Kazi and G. Gecin

University of Novi Sad, Technical Faculty „Mihajlo Pupin“, Zrenjanin, Republic of Serbia  
lidija.perisic82@gmail.com, ljubica.kazi@gmail.com, gorancecin@gmail.com

**Abstract** – This paper describes the application of security aspects of web services within business applications. Like any software or web application, web services are also prone to security threats related to authentication, availability and integrity, so that new techniques and methods in the field of Web service security and data protection and existing implemented solutions will be described. In addition, a special web service has been created, which shows how to authenticate and authorize calls to perform operations and how to access resources.

## I. INTRODUCTION

Web services provide a framework for the development, integration and interoperability of distributed software applications. The widespread adoption of web service technologies in business applications will depend of building highly reliable services. Web services promise huge benefits in terms of productivity, efficiency and accuracy. While offering benefits, web services pose daunting challenges in terms of security. Also, they can expose data, applications and systems to various threats. Web services are built on multiple technologies that work together with the development of standards, to ensure security and the ability to work independently.

## II. WEB SERVICES

A Web service is an interface that describes a collection of operations that are network-accessible through standardized XML messaging. A Web service is described using a standard, formal XML notion, called its service description. The web service includes all the details necessary to interact with the service, including message formats, transport protocols, and location. The interface hides the implementation details of the services, allowing it to be used independently of the hardware or software platform on which it is implemented and also independent of the programming language in which it is written. This allows web services-based applications to be loosely coupled, component-oriented, cross-technology implementations. Web services can be used alone or with other web services to perform complex aggregation or a business transaction. [4]

A web service is an interface positioned between an application code and a user of that code. It acts as an abstraction layer, separating the platform and programming-language-specific details of how the application code is actually invoked. This standardized

layer means that any language that supports the web service can access the application's functionality [3].

Today, it has become common for businesses to connect their business systems with relevant applications in other businesses and to open up some of their business to the community and make it available to the general public.

“Cisco Systems Interconnects Its Suppliers into One System,” this powerful company that focuses its business on the Internet, has achieved enviable business success by integrating its business systems with those of its key manufacturing partners. [7]

Insurance companies are accelerating the process of quoting a new insurance policy by using the services of other companies, including the credit bureau, which the company has contracted to provide these services for a certain part of the business. In order to introduce a new quotation process, the company has designed a web-enabled system that is interoperable with the IT application in the credit bureau. The application works perfectly, even though it extends beyond the borders of multiple separate companies. [7]

### A. Web services architecture

The Web Services architecture is based upon the interactions between three roles: service provider, service registry and service requestor. The interactions involve publish, find and bind operations. Together, these roles and operations act upon the Web Services artifacts: the web service software module and its description. In a typical scenario, a service provider hosts a network-accessible software module (an implementation of a Web service). The service provider defines a service description for the Web service and publishes it to a service requestor or service registry. The service requestor uses a find operation to retrieve the service description locally or from the service registry and uses the service description to bind with the service provider and invoke or interact with the Web service implementation. [4] [3]

From a business perspective, the service provider is the owner of the service. From an architectural perspective, this is a platform that hosts access to the service. A service requestor from a business perspective is a business that requires certain functions to be satisfied; from an architectural perspective, it is an application that is looking for and invoking or initiating an interaction with the service. A service

registry is a searchable registry of service descriptions where service providers publish their service descriptions. [4]

For a web service to be available, service description needs to be published so that the service requestor can find it. In the find operation, the service requestor retrieves a service description directly or queries the service registry for the type of service required. Finally, the service must be invoked - the bind operation service requestor invokes or it initiates an interaction with the service at runtime using the binding details in the service description to locate, contact and invoke the service [4].

Figure 1 illustrates the web service architecture

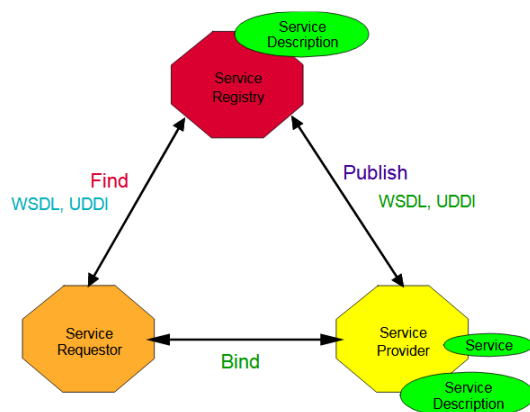

Figure 1. The web services architecture [4]

### III. WEB SERVICE SECURITY

The client-server processing model specific to the first network applications has been transformed into a service-based model. The role of web services is to share data and access various services, providing users with a unique public interface. They are organized in a service-oriented architecture, are XML based, and use SOAP as a protocol for exchanging data between applications through dynamic and ad hoc connections.

Web services provide a framework for the development, integration and interoperability of distributed software applications. The widespread adoption of web service technologies in mission-critical business applications will depend on the feasibility of building highly reliable services. The main benefits of web services are related to flexibility and versatility, as they support different architectures and are platform and model independent.

Many authors and security experts believe that web service attacks are likely to be similar to web application attacks, but more sophisticated. The problem is that XML messages contain textual information that describes them. Attackers get more detailed information through WSDL files and UDDI entries. Web services require security that offers consistency. Openness of web services contradicts

security, on the other hand contributes to simple and easy implementation and drastic cost reduction. [1]

The biggest threats that web services face are:

- Message alteration - An attacker can insert, delete or modify information in a message with the purpose to deceive the receiver.
- Loss of confidentiality - The information from a message is revealed by an unauthorized person,
- Falsified message - The attacker falsifies the original messages so that the recipient believes they come from trusted senders,
- Man in the middle - Appears when a third party appears in the communication between the sender and the recipient. Two participants are not aware if the message has not been attacked, allowing attackers to view and/or modify messages,
- Reply of message - send messages that have already been sent,
- Denial of Service - The attacker causes the system to consume resources disproportionately so that valid requirements cannot be met. [2]

All software applications, including web services, must meet performance, cost, usability and security requirements. Web service security provides the following security services: authentication, authorization, auditing, confidentiality, integrity and availability. Several organizations, including W3C, OASIS, Liberty Appliance, have compiled a database of several web service security standards and techniques:

- SSL (Secure Socket Layer) and TLS (Transport Layer Security) are security protocols that provide protection for SOAP messages at the communication level.
- XML Encryption and XML Signature are the basic standards that determine how to encrypt and sign XML data using various supported encryption and signature algorithms.
- WS-Security and WS-Secure Conversation defines how XML signatures and XML encryption and SOAP message security credentials are used, ensuring the authenticity, integrity and confidentiality of messages. The WS-Security standard supports tokens for security mechanisms, such as Kerberos and X.509 certificates.
- WS-Reliability and WS-Reliable Messaging are the basic standards for the reliability of messages sent over a public network. They focus on the message delivery guarantee and define the protocols necessary to ensure that messages are not rejected.
- SAML (Security Assertion Markup Language), is an XML-based standard for the exchange of authorization and authentication messages

between service providers and requesters of services or security domains. SAML solves the single sign-on problem by using security tokens.

- Extensible Access Control Markup Language (XACML) and XACMLProfile for web services offer security policies and access rights to Web services and other resources.
- XML Key Management Standard (XKMS), defines the standard service, interfaces and protocols for managing cryptographic keys.
- WS-Trust defines extensions that are based on WS-Security for requesting and issuing security tokens.
- Security Management Standard, defines how to manage credentials using digital certificates and PKIs.
- Identity Management, defines how to manage user identity, providing access control to resources. [2] [13][14][15][16]

#### IV. WEB SERVICES SECURITY IN BUSINESS APPLICATIONS

What the web has done to interact with the program and the users, the web services are ready to do to interact between the programs. Web services enable companies to reduce e-commerce costs, implement solutions faster, and open up new opportunities. The key is a common model of communication between programs, based on existing and emerging standards such as HTTP, XML, SOAP, WSDL and UDDI.

The spread of the idea of distributed data processing and sharing of functionality with other organizations has led to the accelerated development of the Web. No longer are organizations focused only on developing their own applications to grow their business, but opening up some of their business to the community and making it accessible to the general public. However, sharing functionality also means sharing its shortcomings, that is, the security weaknesses of a service have an impact on the business of the organizations that use the service. The increasing use of web services in business increases the need for more specific security methodologies.

Web services allow applications to integrate faster, easier and less costly. Integration takes place at a higher level in the protocol set, based on messages that are more focused on the semantics of the service and less on the semantics of the network protocol, thus enabling the integration of business functions. These features are ideal for connecting business functions across the web between businesses and within businesses. They provide a unified programming model such that application integration inside and outside the enterprise can be done using a common approach, using a common infrastructure. [4]

##### A. WS-BPEL

Web Services Business Process Execution Language WS-BPEL is a language for executing business processes. The processes in WS-BPEL are based on the use of web services. Business processes can be described in two ways. Executive business processes, model the actual behavior of participants in business interaction. Abstract business processes are partially specified processes that are not intended to be executed, may hide some of the specific operational details required. WS-BPEL provides a language for specifying executable and abstract business processes. This extends the web service interaction model and enables business transaction support. WS-BPEL defines an interoperable integration model that should facilitate the expansion of automated process integration in the B2B (business-to-business) model. [10]

WS-BPEL is XML based and defines a model and means for describing process behavior and enables process execution, consisting of web service invoke. The BPEL language provides a description of business process behavior as a series of activities, including their branches, that are involved in the process, while activities are represented by web services. [8]

WS-BPEL defines a model and a grammar for describing the behavior of a business process based on interactions between the process and its partners. The interaction with each partner occurs through Web Service interfaces, and the structure of the relationship at the interface level is encapsulated in what is called a partnerLink. The WS-BPEL process defines how multiple service interactions with these partners are coordinated to achieve a business goal, as well as the state and the logic necessary for this coordination. [10]

The goal of web services effort is to achieve interoperability between applications using web standards. Web services use a loosely coupled integration model to allow flexible integration of heterogeneous systems in a variety of domains, including business-to-consumer integration, business-to-business and enterprise application integrations. System integration requires more than the ability to conduct simple interactions using standard protocols. The full potential of web services as an integration platform will only be achieved when applications and business processes are able to integrate their complex interactions by using standard process integration model. [10]

It is crucial to control access to BPEL processes and to the web services they use. Preventing unauthorized users from breaking into system is required to protect both the integrity of processes and the personal information of customers.[9]

Security implementation is achieved through:

- *WS-Security* provides a mechanism for adding three levels of security to simple object access

protocol (SOAP) messages. These security levels are as follows: Authentication tokens – used for passing user name and password information, as well as X.509 certificates, within the SOAP message headers; XML encryption – used for message confidentiality; XML digital signatures – used for message integrity, source and origin validation, and non repudiation.

- *Authentication* is the process of proving the identity of a user.
- *Authorization* is the evaluation of security constraints to send a message or make a request. Authorization uses specific criteria to determine whether to permit the request.
- *Encryption and decryption*- Encryption is the practice of encoding (encrypting) data in such a way that only an intended recipient can decode (decrypt) and read the data.
- *Secure Socket Layer (SSL)* is a standard for the secure transmission of documents over the Internet using HTTP/S (secure HTTP). SSL uses digital signatures to prevent data from being compromised.
- *Digital signature*(for integrity and non-repudiation) - A digital signature is a code attached to an electronic document that reliably identifies the author or sender, and verifies that the document has not been compromised.
- *BPEL Security Extension* are designed for BPEL developers to improve security, allow them to create custom security. Extensions are technical and include various technologies used to call the process (for example, SOAP and HTTP). [96]

## V. EXISTING SOLUTIONS

The National Bank of Serbia publishes some of its data to the public through a set of appropriate public web services. In this way, the public has access to data held by the National Bank of Serbia, using consistent programming interfaces, based on adopted international standards. [11]

With the web services system, the National Bank of Serbia enables legal entities to automate access to the information offered and use it in their information systems in a way that best suits their needs.

Web service implementation consists of the following steps: creating a web service client based on the WSDL service specification, implementation of program code, which allows calling service methods.

When creating a client web service, an AuthenticationHeader class will be generated, which contains the following properties: UserName, Password, LicenseID. These parameters serve to

authenticate and authorize users when calling a service and are obtained from the National Bank of Serbia upon membership. When calling service methods, you must pass instances of the AuthenticationHeader class with the parameters set. Listing 1 shows all the steps required to implement an authentication mechanism on a web service client. The specific code depends on the technology in which the web service client is deployed. [12]

*Listing 1*

```
// instantiating the AutehenticationHeader class
and assigning values to the parameters
AuthenticationHeaderauthHeader=new AuthenticationHeader
();
authHeader.UserName="*****";
authHeader.Password="*****";
authHeader.LicenceID="00000000-0000-0000-0000-
000000000000";

//passing the AuthenticationHeader instance to the
class
serviceClient.AuthenticationHeader=authHeader;

// calling web service method
serviceClient.GetCurrentExchangeRate(1);
```

## VI. A CASE STUDY

### A. Description of Business Context

An example that shows the implementation of security techniques in web services, is a distribution center, that is, a web service call in an online ordering application. The web service is designed to show the warehouses where the goods are in stock for a specific commodity code, and based on the returned result of the web service call, select the warehouse closest to the delivery point. The goal of the APP is to choose the closest delivery location to reduce shipping costs.

Figure 3 illustrates the result of a web service call in an application.

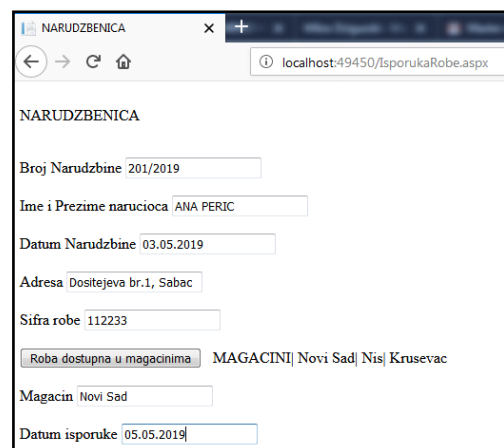

Figure2.The result of web service call in an application



### B. Security aspects of web service implementation in a web application

The security aspects of implementing web services in an application are accomplished by adding a security layer in the SOAP header. The credentials in the SOAP header define the special element used to pass the username and password to the web service, which are used for authentication. When calling a web service, the credentials must be provided to the calling service.

Listing 2 shows class AuthHeader, which is a SoapHeader type class that lets pass in username and password when the web service is called. Then, UserName and Password variables are defined. They are used to store the username and password values that are passed to the web service.

Listing 2.

```
public class AuthHeader : SoapHeader
{
    public string UserName;
    public string Password;
}
```

Listing 3 shows the SOAP credential header, UserName and Password.

Listing 3.

```
POST /WSStanjeRobePoMagacinima.asmx HTTP/1.1
Host: localhost
Content-Type: text/xml; charset=utf-8
Content-Length: length
SOAPAction:
"http://tempuri.org/StanjeZalihaRobe"
<?xml version="1.0" encoding="utf-8"?>
<soap:Envelope xmlns:xsi="http://www.w3.org/2001/XMLSchema-instance"
xmlns:xsd="http://www.w3.org/2001/XMLSchema"
xmlns:soap="http://schemas.xmlsoap.org/soap/envelope/">
<soap:Header>
<AuthHeader xmlns="http://tempuri.org/">
<UserName>string</UserName>
<Password>string</Password>
</AuthHeader>
</soap:Header>
<soap:Body>
<StanjeZalihaRobe xmlns="http://tempuri.org/"
>
<SifraRobe>string</SifraRobe>
</StanjeZalihaRobe>
</soap:Body>
</soap:Envelope>
```

If an incorrect parameter, username or password is entered, authentication will not be possible and the user will receive a message that he or she is not authorized to use the service, as shown in Figure 4.

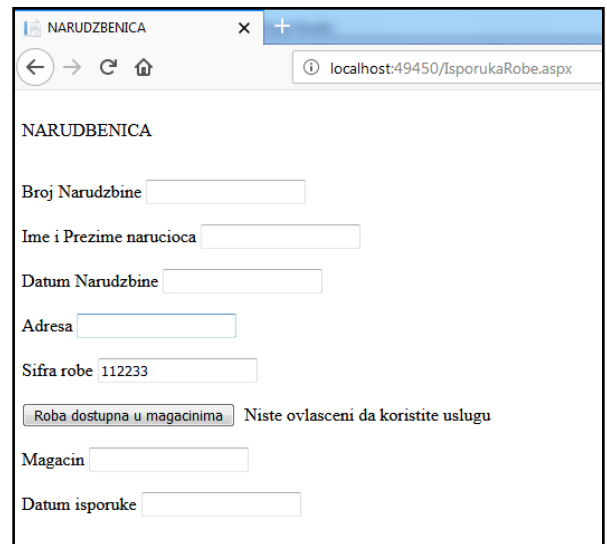

Figure3 Error message

## VII. CONCLUSION

This paper describes the security aspects, techniques, and methods of deploying web services within business applications. Specific security techniques and methods are also provided to ensure the secure implementation of web services in business applications and to secure the distribution of data. Through concrete examples, it has been shown that modern web application development technologies enable interaction with web services and application of security elements. Further research related to the security of web service deployment in business applications could relate to new security methods and techniques, as well as the implementation of security tokens, encryption methods and electronic certificates, as well as web service security testing tools and methods that are not realized in this paper.

## REFERENCES

- [1] E. Moradian, A. Hakansson: *Possible attacks on XML Web Services*, International Journal of Computer Science and Network Security IJCSNS, Vol. 6, No. 1B, January 2006, available at: [https://www.researchgate.net/publication/241442248\\_Possible\\_attacks\\_on\\_XML\\_Web\\_Services](https://www.researchgate.net/publication/241442248_Possible_attacks_on_XML_Web_Services)
- [2] S. Dumitra, B. Vasilciuc: *Securing Web Services using Service Token Security*, Journal of Mobile, Embedded and Distributed Systems, vol.VI, No. 2, 2014, ISSN 2067-4074 available at: [http://www.jmeds.eu/index.php/jmeds/article/view/Securing\\_Web\\_Services\\_using\\_Service\\_Token\\_Security/pdf\\_7](http://www.jmeds.eu/index.php/jmeds/article/view/Securing_Web_Services_using_Service_Token_Security/pdf_7)
- [3] P. Kulchenko, D. Tidwell, J. Snell: *Programming Web Services with SOAP*, O'Reilly, February 2009. available at: <https://www.oreilly.com/library/view/programming-web-services/0596000952/ch01.html>
- [4] H. Kreger: *Web Service Conceptual Architecture (WSCA 1.0)*, IBM, May 2001, available at: <https://www.csd.uoc.gr/~hy565/docs/pdfs/papers/wsca.pdf>
- [5] *Service-oriented architecture, Introduction to SOA*, IBM knowledge center, [https://www.ibm.com/support/knowledgecenter/en/SSMQ79\\_9.5.1/com.ibm.epl.pg.doc/topics/peg1\\_serv\\_overview.html](https://www.ibm.com/support/knowledgecenter/en/SSMQ79_9.5.1/com.ibm.epl.pg.doc/topics/peg1_serv_overview.html) accessed: 10.05.2019

- [6] E. Ort: Service-Oriented Architecture and Web Services: Concepts, Technologies, and Tools, Oracle technology network, April 2005, available at: <https://www.oracle.com/technetwork/articles/javase/wsprotocols-136863.html> accessed: 14.05.2019
- [7] Creating web applications, XML and web services (In Serbian: Kreiranje Web aplikacija, XML i web servisi), lecture notes, Faculty of Mechanical sciences, University of Nis, Serbia available at: [http://ttl.masfak.ni.ac.rs/21IT/Predavanje\\_4\\_INTERNET\\_WEB\\_aplikacije.pdf](http://ttl.masfak.ni.ac.rs/21IT/Predavanje_4_INTERNET_WEB_aplikacije.pdf) accessed: 13.05.2019
- [8] WS-BPEL (Web Services Business Process Execution Language), Management Mania, available at: <https://managementmania.com/en/ws-bpel-web-services-business-process-execution-language> accessed: 26.05.2019
- [9] Oracle BPEL Process Manager Security, Oracle BPEL Process Manager Administrator's guide, available at: [https://docs.oracle.com/cd/E12483\\_01/integrate.1013/b28982/security.htm](https://docs.oracle.com/cd/E12483_01/integrate.1013/b28982/security.htm) accessed: 27.05.2019
- [10] Web Services Business Process Execution Language Version 2.0., OASIS Standard 11 April 2007, available at: <http://docs.oasis-open.org/wsbpel/2.0/wsbpel-v2.0.html> accessed: 26.05.2019
- [11] Web services of National Bank of Serbia portal, available at: <https://www.nbs.rs/internet/cirilica/16/index.html> accessed: 01.06.2019
- [12] System of web services at National Bank of Serbia, technical documentation, available at: <https://webservices.nbs.rs/CommunicationOfficeSiteDoc/SerCyr/default.html> accessed: 01.06.2019
- [13] Fusion Middleware Security and Administrator's Guide for Web Services, Oracle Help Center, available at: [https://docs.oracle.com/cd/E17904\\_01/web.1111/b32511/standards.htm#WSSEC1117](https://docs.oracle.com/cd/E17904_01/web.1111/b32511/standards.htm#WSSEC1117) accessed: 18.05.2019
- [14] XML encryption, IBM, available at: [https://www.ibm.com/support/knowledgecenter/en/SSAW57\\_8.5.5/com.ibm.websphere.nd.multiplatform.doc/ae/cwbs\\_encryptv6.html](https://www.ibm.com/support/knowledgecenter/en/SSAW57_8.5.5/com.ibm.websphere.nd.multiplatform.doc/ae/cwbs_encryptv6.html) accessed: 21.05.2019
- [15] WS-Security (Web Services security), IBM, available at: [https://www.ibm.com/support/knowledgecenter/en/SSMKH10.0.0/com.ibm.etools.mft.doc/ac55630\\_.html](https://www.ibm.com/support/knowledgecenter/en/SSMKH10.0.0/com.ibm.etools.mft.doc/ac55630_.html) accessed: 25.05.2019
- [16] What is SAML and How Does it Work, VARONIS, available at: <https://www.varonis.com/blog/what-is-saml/> accessed: 25.05.2019

# Design and Analysis of DC Motor Using Softver Tool MATLAB Simulink

V. Šinik\*, Ž. Despotović\*\* and D. Dobrilović\*

\*University of Novi Sad, Technical Faculty "Mihajlo Pupin", Zrenjanin, Serbia

\*\*Institute "Mihajlo Pupin", Belgrade, Serbia

sinik.vladimir@gmail.com, boban@iee.org, dalibor.dobrilovic@gmail.com

**Abstract** - Many industrial applications require high performance rotating electric drives. A proposed DC drive have a precise speed control, stable operation in complete range of speed and good transient behavior with smooth and step less control. In this paper, modeling of a DC motor is performed by using generalized equation in MATLAB. The speed control of the DC motor was realized using a PID controller.

**Key words:** PID controller, DC motor, MATLAB representation

## I. INTRODUCTION

A DC motor is an electromechanical energy converter which converts electrical energy into mechanical energy. It is often used as an actuator in control systems.

The DC motor acts as an energy conversion actuator that converts electrical energy (of source) into mechanical energy (for load). These motors are extensively applied for robotic manipulations, cutting tools, electrical tractions, etc. The torque-speed characteristics of DC motors are most compatible with most mechanical loads. Hence DC motors are always a good ground for advanced control algorithm. The control characteristics of these motors have resulted to their immense use and hence control of their speed is required. Speed of a DC motor depends on supply voltage, armature resistance and field flux produced by the field current. The methods to control speed of these motors are armature voltage control, armature resistance control and field flux control [1].

The parameters of the PID controller  $K_p$ ,  $K_i$ , and  $K_d$  (or  $K_p$ ,  $T_i$  and  $T_d$ ) can be manipulated to produce various response curves from a given process as we will see later. [2].

## II. MODELING AND BLOCK DIAGRAMS OF A DC MOTOR

As The DC motor model is implemented by mathematical expression. This implemented model is analysed by techniques of time domain and frequency domain analysis in MATLAB simulation.

### A. Physical System

Figure 1 depicts the electrical circuit and free body of a closed loop system of DC motor.

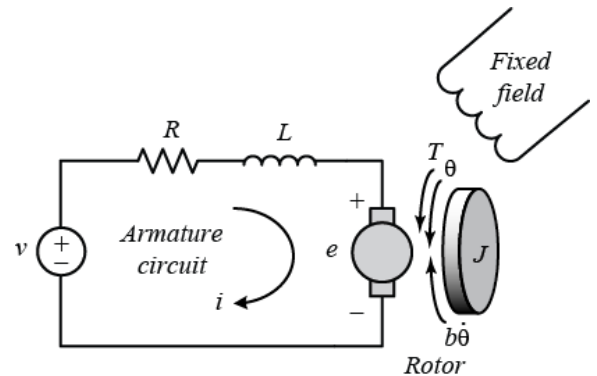

Figure 1. Free body diagram of armature of a DC motor [3]

The basic equations of a DC motor (electric part) are obtained from Maxwell's electromagnetic theory. For this example, we will assume that the input of the system is the voltage source ( $V$ ) applied to the motor's armature, while the output is the rotational speed of the shaft  $d(\theta)/dt$ . The rotor and shaft are assumed to be rigid. We further assume a viscous friction model, that is, the friction torque is proportional to shaft angular velocity.

### B. State Space Modelling

For continuous linear time invariant (LTI) systems, the standard state-space representation is given below:

$$\begin{aligned}\dot{\bar{x}} &= A\bar{x} + B \cdot u \\ y &= C\bar{x} + D \cdot u\end{aligned}\quad (1)$$

where  $\mathbf{x}$  is the vector of state variables ( $n \times 1$ ),  $\dot{\mathbf{x}}$  is the time derivative of state vector ( $n \times 1$ ),  $\mathbf{u}$  is the input or control vector ( $p \times 1$ ),  $\mathbf{y}$  is the output vector ( $q \times 1$ ),  $\mathbf{A}$  is the system matrix ( $n \times n$ ),  $\mathbf{B}$  is the input matrix ( $n \times p$ ),  $\mathbf{C}$  is the output matrix ( $q \times n$ ),  $\mathbf{D}$  is the feedforward matrix ( $q \times p$ ) [4].

The output equation, is necessary because often there are state variables which are not directly observed or are otherwise not of interest. The output matrix,  $\mathbf{C}$ , is used to specify which state variables (or combinations thereof) are available for use by the controller. Also often there is no direct feedforward in which case  $\mathbf{D}$  is the zero matrix

In general, the torque generated by a DC motor is proportional to the armature current and the strength of the magnetic field. In this example we will assume that the

magnetic field is constant and, therefore, that the motor torque is proportional to only the armature current  $i$  by a constant factor  $Kt$  as shown in the equation below. This is referred to as an armature-controlled motor

$$T = K_t i \quad (2)$$

The back emf,  $e$ , is proportional to the angular velocity of the shaft by a constant factor  $Ke$

$$e = K_e \dot{\theta} \quad (3)$$

In SI units, the motor torque and back emf constants are equal, that is,  $Kt = Ke$ ; therefore, we will use  $K$  to represent both the motor torque constant and the back emf constant.

From the figure above, we can derive the following governing equations based on Newton's 2nd law and Kirchhoff's voltage law

$$J \ddot{\theta} + b \dot{\theta} = Ki \quad (4)$$

$$L \frac{di}{dt} + Ri = V - K \dot{\theta} \quad (5)$$

where  $J$  stands for moment of inertia,  $b$  stands for friction coefficient,  $L$  is armature inductance,  $R$  stands for armature resistance,  $V$  stands for input voltage,  $K$  stands for electromotive force constant, stands for angular acceleration [4]. In state-space form, the governing equations above can be expressed by choosing the rotational speed and electric current as the state variables. Again the armature voltage is treated as the input and the rotational speed is chosen as the output.

$$\frac{d}{dt} \begin{bmatrix} \dot{\theta} \\ i \end{bmatrix} = \begin{bmatrix} -\frac{b}{J} & \frac{K}{J} \\ -\frac{K}{L} & -\frac{R}{L} \end{bmatrix} \begin{bmatrix} \dot{\theta} \\ i \end{bmatrix} + \begin{bmatrix} 0 \\ \frac{1}{L} \end{bmatrix} V \quad (6)$$

$$y = \begin{bmatrix} 1 & 0 \end{bmatrix} \begin{bmatrix} \dot{\theta} \\ i \end{bmatrix} \quad (7)$$

where

$$A = \begin{bmatrix} -\frac{b}{J} & \frac{K}{J} \\ -\frac{K}{L} & -\frac{R}{L} \end{bmatrix}, B = \begin{bmatrix} 0 \\ \frac{1}{L} \end{bmatrix}, C = \begin{bmatrix} 1 & 0 \end{bmatrix}, D = 0 \quad (8)$$

### C. Laplace Transform Expression

LTI systems have the extremely important property that if the input to the system is sinusoidal, then the output will also be sinusoidal at the same frequency but in general with different magnitude and phase. These magnitude and phase differences as a function of frequency are known as the frequency response of the system.

Using the Laplace transform, it is possible to convert a system's time-domain representation into a frequency-domain output/input representation, known as the transfer function. In so doing, it also transforms the governing differential equation into an algebraic equation which is often easier to analyze.

Applying the Laplace transform, the above modeling equations can be expressed in terms of the Laplace variable  $s$ .

$$s(Js + b)\theta(s) = KI(s) \quad (9)$$

$$(Ls + R)I(s) = V(s) - Ks\theta(s) \quad (10)$$

Here  $s$  is the Laplace operator,  $\theta(s)$  represents angular displacement in  $s$  domain. From Equation (10)  $I(s)$  is given as:

$$I(s) = \frac{V(s) - Ks\theta(s)}{R + sL} \quad (11)$$

The substituted in Equation (9) to obtain:

$$Js^2(\theta)s + bs\theta(s) = K \frac{V(s) - Ks\theta(s)}{R + sL} \quad (12)$$

We arrive at the following open-loop transfer function by eliminating  $I(s)$  between the two above equations, where the rotational speed is considered the output and the armature voltage is considered the input.

$$W_v(s) = \frac{\omega(s)}{V(s)} = \frac{K}{(Js + b)(Ls + R) + K^2} \quad (13)$$

From Equation (12), the transfer function (the ratio of  $\theta(s)$  to voltage  $V(s)$ ) is:

$$W_\theta(s) = \frac{\theta(s)}{V(s)} = \frac{K}{s((Js + b)(Ls + R) + K^2)} \quad (14)$$

This Laplace Equation for the DC motor is implemented by the block diagram in Figure 2.

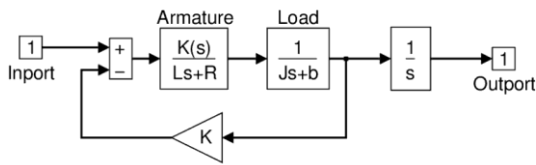

Figure 2. Modeled block diagram of a DC motor

### III. ANALYSIS OF DC MOTOR IN MATLAB

#### A. MATLAB Representation

In this paper, the dynamic modeling of DC motor is implemented using Laplace transform expression. The transfer function from Laplace transform expressions is put into MATLAB m-file by defining the polynomial. The transfer function is put in MATLAB using Voltage as input and velocity and angle as output.

##### 1) Time-Domain Responses

Here the step response, impulse response and maps zero and pole of the modeled DC motor is depicted from Figure 3 to 4.

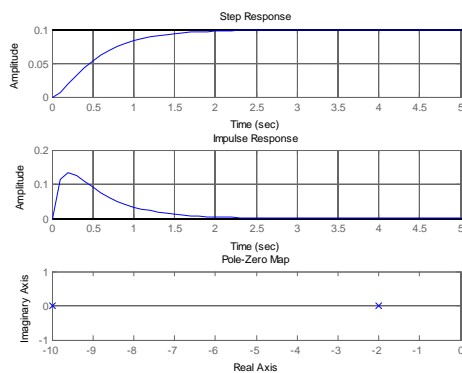

Figure 3. Step response, impulse response and maps zero and pole of the transfer function  $W_v(s)$

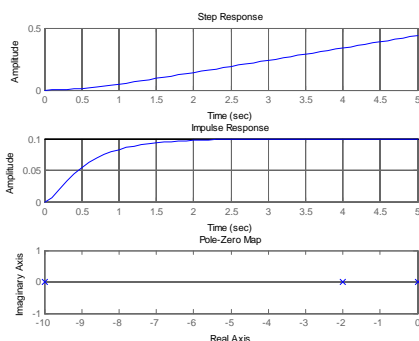

Figure 4. Step response, impulse response and maps zero and pole of the transfer function  $W_o(s)$

#### 2) Frequency-Domain Responses

##### a) Drawing the original Bode plot

The main idea of frequency-based design is to use the Bode plot of the open-loop transfer function to estimate the closed-loop response. Adding a controller to the system changes the open-loop Bode plot, thereby changing the closed-loop response. It is our goal to design the controller to shape the open-loop Bode plot in such a way that the closed-loop system behaves in a desired manner. Let's first draw the Bode plot for the original open-loop plant transfer function. Bode response of the transfer function  $W_v(s)$  and  $W_o(s)$  give on Figure 5. and Figure 6.

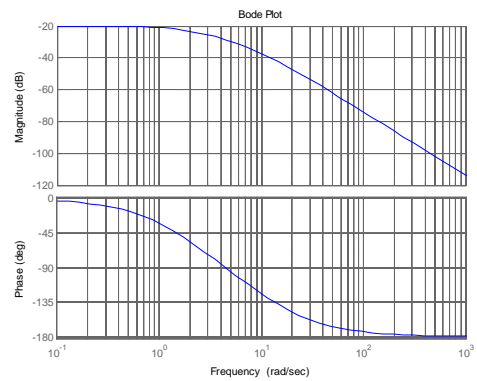

Figure 5. Bode response of the transfer function  $W_v(s)$

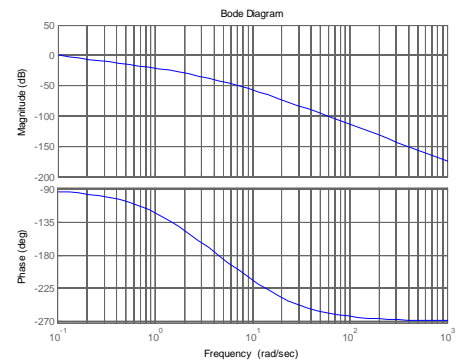

Figure 6. Bode response of the transfer function  $W_o(s)$

##### b) Adding proportional gain

From the Bode plot above, it appears that the gain margin and phase margin of this system are currently infinite which indicates the system is robust and has minimal overshoot. The problem with this is that the phase margin is infinite because the magnitude plot is below 0 dB at all frequencies. This indicates that the system will have trouble tracking various reference signals without excessive error. Therefore, we would like to increase the gain of the system while still achieving enough phase margin [4].

A phase margin of 60 degrees is generally sufficient for stability margin. From the above Bode plot, this phase margin is achieved for a crossover frequency of approximately 10 rad/sec. The gain needed to raise the magnitude plot so that the gain crossover frequency occurs at 10 rad/sec appears to be approximately 40 dB. The exact phase and gain of the Bode plot at a given frequency can be determined by clicking on the graph at the corresponding frequency. The bode command, invoked with left-hand arguments, can also be used to provide the exact phase and magnitude at 10 rad/sec as shown below. With command [mag,phase,w] we going mag = 0.0139, phase = -123.6835, w = 10

Therefore, the exact phase margin for a gain crossover frequency of 10 rad/sec is  $180 - 123.7 = 56.3$  degrees. Since the exact magnitude at this frequency is  $20 \log 0.0139 = -37.1$  dB, 37.1 dB of gain must be added to the system. Otherwise stated, a proportional gain of  $1/0.0139 = 72$  will achieve an open-loop gain of 1 at 10 rad/sec. Add the following commands to your m-file to observe the effect of this proportional controller on the system. In this case, we use the margin command instead of the bode command in order to explicitly see the new gain and phase margins and crossover frequencies [4].

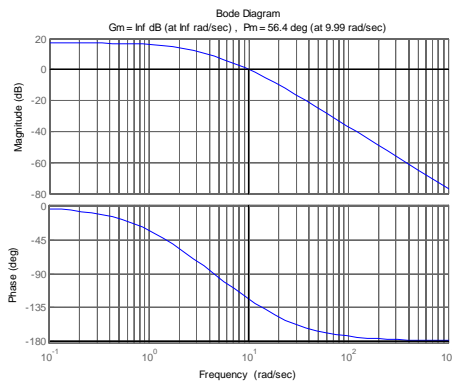

Figure 7. The exact phase and magnitude at 10 rad/sec

*c) Plotting the closed-loop response and adding a lag compensator*

From the plot above we see that the resulting phase margin and gain crossover frequency are as we expected. Let's see what the closed-loop response look like.

Note that the settling time is fast enough, but the overshoot and the steady-state error are too high. The overshoot can be reduced by decreasing the gain in order to achieve a larger phase margin, but this would cause the steady-state error to become even larger. A lag compensator could be helpful here in that it can decrease the gain crossover frequency in order to increase the phase margin without decreasing the system's DC gain.

Consider the following lag compensator:

$$C(s) = \frac{(s + 1)}{(s + 0.01)} \quad (15)$$

This lag compensator has a DC gain of  $1/0.01 = 100$  which means it will increase the system's static position error constant by a factor of 100 and will reduce the steady-state error associated with the system's closed-loop step response. In fact, it allows us to reduce the proportional gain of 72 used earlier, while still meeting the requirement on steady-state error. We will employ a gain of 45. Furthermore, since the corner frequencies of the pole and zero are a decade or more below the current gain crossover frequency of 10 rad/sec, the phase lag contributed by the compensator shouldn't adversely affect performance much [4].

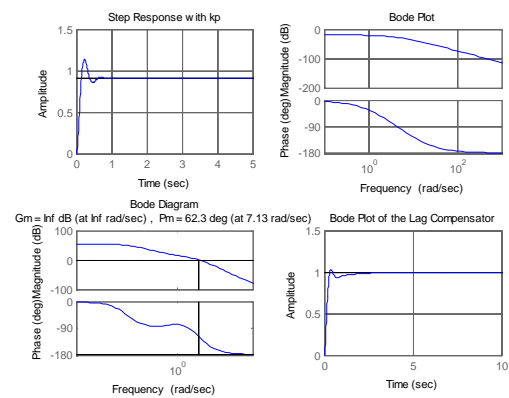

Figure 8. (1)Plotting the closed-loop response, (2)adding proportional gain, (3)Bode plot of the lag compensator (4) step response with lag compensator

Inspection of the above demonstrates that all of the given requirements are now met when the lag compensator described above is employed.

**B. PID controller Design**

PID controllers are commonly used to regulate the time-domain behavior of many different types of dynamic plants. These controllers are extremely popular because they can usually provide good closed-loop response characteristics, can be tuned using relatively simple design rules, and are easy to construct using either analog or digital components. Consider the feedback system architecture that is shown in Figure 9. where it can be assumed that the plant is a DC motor whose speed must be accurately regulated.

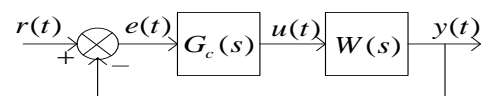

Figure 9. Feedback system architecture

The PID controller is placed in the forward path, so that its output becomes the voltage applied to the motor's armature the feedback signal is a velocity, measured by a tachometer .the output velocity signal  $y(t)$  is summed with a reference or command signal  $r(t)$  to form the error signal  $e(t)$ . Finally, the error signal is the input to the PID controller. Before examining the input-output relationships and design methods for the PID controller, it is helpful to review typical characteristics observed for the velocity response of a DC motor to a step voltage input. Different characteristics of the motor response (steady-state error, peak overshoot, rise time, settling time, etc) are controlled by selection of the three gains of the PID controller. This is discussed in detail below the PID controller is defined by the following relationship between the controller input  $e(t)$  and the controller output  $u(t)$  that is applied to the motor armature:

$$u(t) = K_p e(t) + K_i \int e(t) dt + K_d \frac{de}{dt} \quad (16)$$

Taking the Laplace transform of this equation gives the transfer function  $G_C(s)$ :

$$G_C(s) = \frac{U(s)}{E(s)} = K_p + \frac{K_i}{s} + K_d s = \frac{K_d s^2 + K_p s + K_i}{s} \quad (17)$$

The block diagram of PID controller with closed loop is depicted in Figure 10.

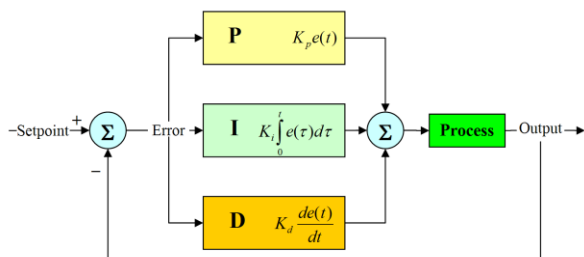

Figure 10. Block diagram of closed loop PID controller

Here,  $U$  = controller output,  $E$  = controller input,  $K_p$ = proportional gain,  $K_i$ = integral gain,  $K_d$ = derivative gain

First, let's take a look at how the PID controller works in a closed-loop system using the schematic shown on Figure 9. The variable  $e(t)$  represents the tracking error, the difference between the desired input value  $r(t)$  and the actual output  $y(t)$  .This error signal  $e(t)$  will be sent to the PID controller, and the controller computes both the derivative and the integral of this error signal. The control signal  $u(t)$  to the plant is equal to the proportional gain ( $K_p$ ) times the magnitude of the error plus the integral gain ( $K_i$ ) times the integral of the error plus the derivative gain ( $K_d$ ) times the derivative of the error.

This control signal  $u(t)$  is sent to the plant, and the new output  $y(t)$  is obtained. The new output  $y(t)$  is then fed back

and compared to the reference to find the new error signal  $e(t)$ . The controller takes this new error signal and computes its derivative and its integral again, ad infinitum.

A proportional controller ( $K_p$ ) will have the effect of reducing the rise time and will reduce but never eliminate the steady-state error. An integral control ( $K_i$ ) will have the effect of eliminating the steady-state error for a constant or step input, but it may make the transient response slower. A derivative control ( $K_d$ ) will have the effect of increasing the stability of the system, reducing the overshoot, and improving the transient response.

The effects of each of controller parameters, ( $K_p$ ) , ( $K_d$ ) , and ( $K_i$ ) on a closed-loop system are summarized in the table below.

Table 1. Influence of controller parameters

CI Response	Rise time	Overshoot	Settling time	S-S Error
$K_p$	Decrease	Increase	Small Change	Decrease
$K_i$	Decrease	Increase	Increase	Eliminate
$K_d$	Small Change	Decrease	Decrease	No Change

Note that these correlations may not be exactly accurate, because  $K_p$ ,  $K_i$ , and  $K_d$  are dependent on each other. In fact, changing one of these variables can change the effect of the other two. For this reason, the table should only be used as a reference when you are determining the values for  $K_p$ ,  $K_i$ , and  $K_d$ .

The goal of this problem is to show you how each of  $K_p$ ,  $K_i$ , and  $K_d$  contributes to obtain : fast rise time, minimum overshoot, no steady-state error.

### 1) Open-Loop Step Response

Let's first view the open-loop step response.

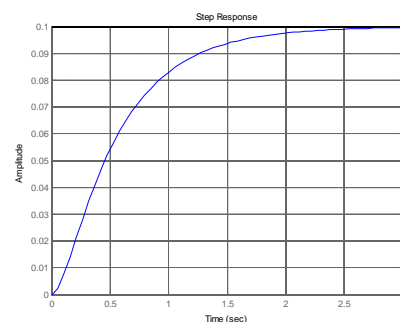

Figure 11. Open-loop step response. of DC motor

The DC gain of the plant transfer function is 1/10, so 0.1 is the final value of the output to an unit step input. This corresponds to the steady-state error of 0.90, quite large indeed. Furthermore, the rise time is about one second, and the settling time is about 3 seconds. Let's design a controller that will reduce the rise time, reduce the settling time, and eliminate the steady-state error.

### 2) Proportional Control

From the table shown above, we see that the proportional controller ( $K_p$ ) reduces the rise time, increases the overshoot, and reduces the steady-state error.

Let's first try using a proportional controller with a gains  $K_{p1} = 100$ ,  $K_{p2} = 200$ ,  $K_{p3} = 50$ ,  $K_{p4} = 10$ ; so we set  $K_i=0$ ,  $K_d=0$ , the corresponding plots was gathered in Figure 12:

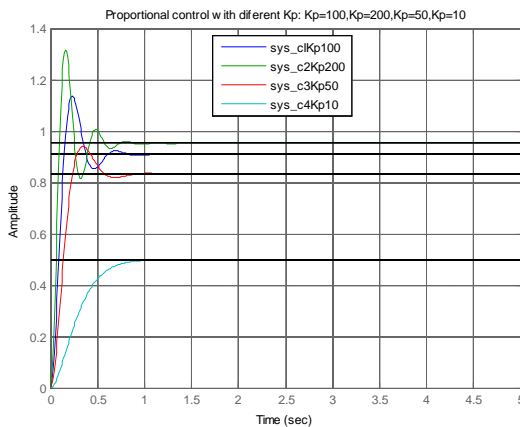

Figure 12. Closed loop response with different values of  $K_p$

From the plot above we see that both the steady-state error and the overshoot are too large. Recall from the Table 1 page that increasing the proportional gain  $K_p$  will reduce the steady-state error. However, also recall that increasing  $K_p$  often results in increased overshoot, therefore, it appears that not all of the design requirements can be met with a simple proportional controller. A little experimentation verifies what we anticipated, a proportional controller is insufficient for meeting the given design requirements; derivative and/or integral terms must be added to the controller.

### 3) Proportional-integral-derivative control (PID)

Recall from the Table 1 page adding an integral term will eliminate the steady-state error to a step reference and a derivative term will often reduce the overshoot. Let's try a PID controller with small  $K_i$  and  $K_d$ .

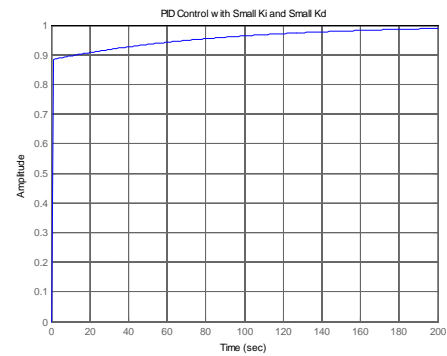

Figure 13. PID Control with Small  $K_i$  and Small  $K_d$

Inspection of the above indicates that the steady-state error does indeed go to zero for a step input. However, the time it takes to reach steady-state is far larger than the required settling time of 2 seconds.

In this case, the long tail on the step response graph is due to the fact that the integral gain is small and, therefore, it takes a long time for the integral action to build up and eliminate the steady-state error. This process can be sped up by increasing the value of  $K_i$ .

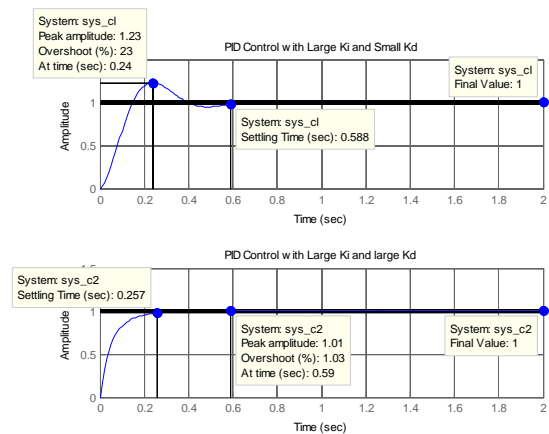

Figure 14. a) PID Control with Large  $K_i$  and Small  $K_d$ , b) PID Control with Large  $K_i$  and large  $K_d$

As expected, the steady-state error is now eliminated much more quickly than before. However, the large  $K_i$  has greatly increased the overshoot (Figure 14 a). Let's increase  $K_d$  in an attempt to reduce the overshoot. As we had hoped, the increased  $K_d$  reduced the resulting overshoot (Figure 14 b). Now we know that if we use a PID controller with  $K_p = 100$ ,  $K_i = 200$ , and  $K_d = 10$ , all of our design requirements will be satisfied.

## IV. CONCLUSION

This paper presents DC motor modeling using generalized equation in MATLAB simulation and to analysis the



performance of this modeled DC motor using PID controller. Here the time domain analysis for both step and impulse signal is discussed. The frequency domain analysis is made by bode plot. From the results we know that the proportional controller ( $K_p$ ) will have the effect of reducing the rise time and will reduce; but never eliminate the steady-state error, an integral control ( $K_i$ ) will have the effect of eliminating the steady-state error, but it may make the transient response worse .a derivative control ( $K_d$ ) will have the effect of increasing the stability of the system, reducing the overshoot, and improving the transient response.

#### REFERENCES

- [1] Pratyusha Biswas Deb, Oindrila Saha, Sajan Saha, Shaon Paul, Dynamic Model Analysis of a DC Motor in MATLAB, International Journal of Scientific & Engineering Research, Volume 8, Issue 3, March-2017 57 ISSN 2229-5518, <http://www.ijser.org>
- [2] Fatiha Loucif , DC motor speed control using pid controller, Department of Electrical Engineering and information, Hunan University, ChangSha, Hunan, China, June 2-5, 2005, KINTEX, Gyeonggi-Do, Korea
- [3] <http://ctms.engin.umich.edu/CTMS/index.php?example=MotorSpeed&section=SystemModeling>, DC Motor Speed: System Modeling
- [4] <http://ctms.engin.umich.edu/CTMS/index.php?example=Introduction&section=SystemModeling>, Control Tutorials for MATLAB & Simulink

# Improved Methods for Control Voltage Inverters. Analysis and Simulations Using the SIMCAD Software Tool

V. Šinik\*, Ž. Janda\*\* and B. Jovanović\*\*

\* University of Novi Sad, Technical Faculty "Mihajlo Pupin", Zrenjanin, Serbia

\*\*EE institute "Nikola Tesla" – Belgrade, Koste Glavinića 8A, 11000 Belgrade, Serbia

sinik.vladimir@gmail.com, janda@ieent.org, blagota.jovanovic@ieent.org

**Abstract** - Pulse width modulation is an important method of the technique of control of power converters. The modulating function contains information regarding the desired waveform, whereas the signal carrier contains information concerning the switching frequency. In this paper we propose an AC power supply with sliding-mode control. It is characterized by both outstanding performance and simple structure. As known, sliding-mode control offers several advantages: stability even for large supply and load variations, robustness, good dynamic response, simple implementation. Application of inverter current control using dual current mode is presented. Dual current mode modulator has excellent static and dynamic characteristics.

**Key words:** inverter, sliding mode, dual current mode

## I. INTRODUCTION

The DC / AC converter - inverter is part of a system of uninterruptible power supply (UPS) that converts direct current from a rechargeable battery to an alternating voltage of mostly sinusoidal shape. The amplitude and frequency of the output voltage should remain approximately constant over the permissible range of change in input voltage and load. Depending on the power of the consumer, single phase (Fig.1) and three phase (Fig.2) inverters are used. Each inverter in the broadest sense consists of an energy part and a control regulation structure.

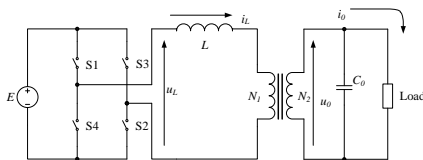

Figure 1. The power circuit of the single phase voltage inverter

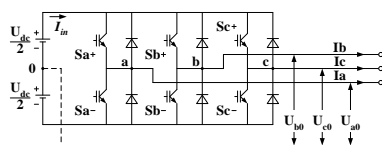

Figure 2. The power circuit of the three phase voltage inverter

Each converter (Fig.1), (Fig.2) has: control structure, power electronics components, energy storage elements, EMI filter, output filter and heat removal system (Fig.3).

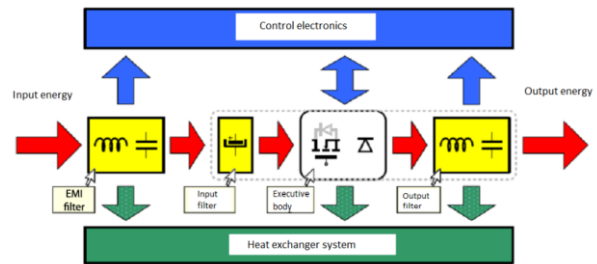

Figure 3. Elements of switching converters

In all UPS inverters the goal is to maintain the desired output voltage waveform over all loading conditions and transients. In the past, sine wave inverters relied on open loop feedforward control to produce the shape of the waveform, while a relatively slow output voltage rms feedback loop regulated the magnitude.

While this type of controller could maintain a desired steady-state rms output voltage, their response to step changes in load were noticeably slow (several cycles of the output waveform), and harmonic loads could greatly distort their output voltage waveform. Today, supply sensitive electronic equipment is pushing the demand for UPS inverters that can deliver "clean" power over all types of loading.

In recent decades, several "instantaneous" controllers have been developed that actively control the inverter's output over the entire waveform. In high quality power supplies, the use of separate single phase units even for multi phase systems is quite common. This allows accurate control of output waveforms in any loading conditions, including unbalanced loads.

## II. INVERTER CONTROL OF THE PULSE WIDTH METHOD

Pulse width modulation (PWM) is an important method of the technique of control of power converters. At the current technological level, three areas within the

pulse width modulation possesses certain autonomy as regards the accomplished solutions. These are: switching strategy of pulse width modulation, concerned with generation of edges of switching pulses, range of regulation of amplitude of the fundamental harmonic of inverter output voltage, and degree of harmonic distortions of inverter output voltage and current [1].

The modulating function contains information regarding the desired waveform, whereas the signal carrier contains information concerning the switching frequency. Pulse edges of a modulated signal are determined by crossings of the modulating function and signal carrier, which makes the basis of all analogue implementations of the modulating function methods involving natural sampling. Signal at the output of a pulse width modulator defines the switching function of the inverter branch which controls the on-state of the switch within the branch. Synthesis of the AC voltage at inverter's output, regulation of the amplitude and frequency, are accomplished by the switching actions in inverter branches.

The basic PWM method is related to the mode of determination of pulse edges. Determination of pulse edges based on crossing of the modulating and carrying signals belongs to the group of natural sampling techniques [1].

The basic shortcoming of the natural sampling technique is tied to the transcendental relation which connects the angles determining pulse edges and modulating function. This aggravated the application of natural sampling technique in digital and microprocessor systems applying PWM methods.

#### A. Natural sampling method

In the natural sampling method, signal edges are determined by crossings of the reference and carrier signals. The leading edge corresponds to the crossing point after which the reference signal becomes higher than the carrier signal. The trailing edge is determined in an analogous way. Fig.4 shows the synthesis of the output voltage of a half-bridge inverter applying the modulating function method and natural sampling.

Due to difficulties in precise generation of complex functions by analogue means and precise determination of crossing points with the carrier signal, the natural sampling method is limited to the sinusoidal modulating signal and triangular carrier signal

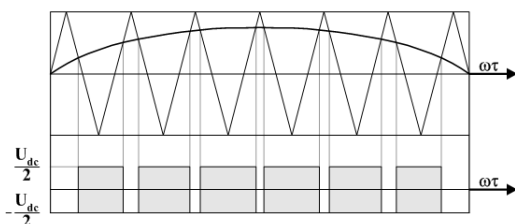

Figure 4. Synthesis of the output voltage of a half-bridge inverter by applying the modulating function method and natural sampling

The basic shortcoming of the natural sampling technique is tied to the transcendental relation which connects the angles determining pulse edges and modulating function. This aggravated the application of natural sampling technique in digital and microprocessor systems applying PWM methods

#### B. Regular sampling method

In the regular sampling method the reference signal is discretized and the pulse edges are determined by comparing the carrier signal with the reference signal modified in this way, which implies a digital realization of the method. Therefore, the regular sampling method has the advantage that microprocessor control is possible compared to the natural sampling method where the pulse edges should be determined by iterative solution of the transcendental equation obtained from the condition for crossing of the reference and carrier (triangular) signals. Fig.5 presents the synthesis of the output voltage of a half-bridge inverter by applying the modulating function method and regular sampling.

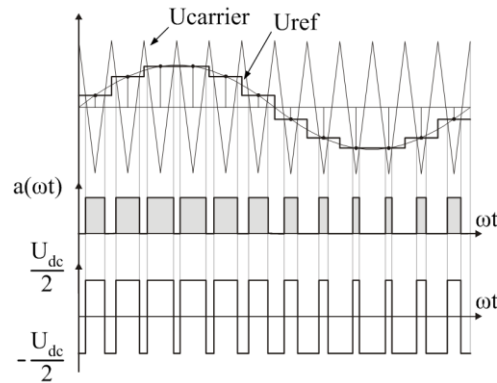

Figure 5. Synthesis of the output voltage of a half-bridge inverter by applying the modulating function method and regular sampling

Regular sampling method is the basic solution for digital realization of the modulating function method. The regular sampling method is considerably more flexible since the modulating function is specified at discrete points, thus it is possible to calculate its values in advance and interpret them by means of digital words [1].

### III. SLIDING MODE INVERTER CONTROL

The enhanced sliding mode control is proposed and applied in the case of output voltage control of the single phase voltage inverter. The fundamentals of the proposed control method are outlined in [2-3]. The power circuit under consideration is shown in Fig. 1. The main drawback of the control method introduced in [2] is the existence of the steady state voltage error between the reference voltage and output voltage, for the case of sinusoidal reference voltage. To overcome this, it is necessary to enhance the sliding mode equation. The main goal in sliding mode control is how to choose the sliding mode equation in order to achieve the exponential decay of the output voltage error.

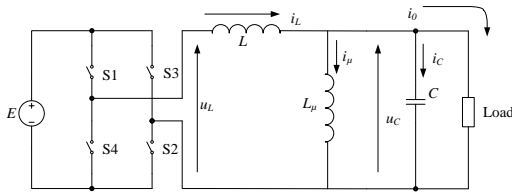

Figure 6. The equivalent power circuit of the single phase voltage inverter [4]

It includes a bridge inverter feeding the insulating transformer. The output filter is made up by smoothing inductor  $L$  and output capacitor  $C$ . The latter also has the purpose of decoupling the load high-frequency components, and to partially compensate for reactive components of the load, which is often inductive. Thus, output capacitor  $C$  is usually sized for 30-35% of the power supply rating.

High accuracy of voltage waveform and of its amplitude is called for, even in the presence of distorting loads and in wide range of load power factors. The ability to withstand overload and short circuit conditions is considered a common feature of these supplies. Thus, in classic control solutions, an inner current loop is often adopted, which also helps to keep the transformer saturation under control and to permit operation of several units in parallel.

System configuration is akin to that of a buck converter, with the addition of the magnetizing inductance. But, the major difference is in the operating conditions: here, the output voltage is required to vary sinusoidally so that there is no steady voltage reference.

The purpose of the sliding-mode control is to force the system status to move on a suitable surface in the state space called the sliding surface. For sliding-mode control, according to [5,6], three conditions must be satisfied: first, the state trajectories near the sliding surface must be directed toward it for both possible states of the switch (existence condition); second, the system trajectories must encounter the sliding plane irrespective of their starting point in the state space (hitting condition); third, the system motion on the sliding plane must reach a stable point corresponding to the desired voltage and current (stability condition). In this work the existence of all necessary conditions is assumed without any examination.

Sliding mode control is accomplished keeping near zero, according to a hysteretic technique, the sliding function (1),

$$s(t) = k_1 \cdot u_C + k_2 \cdot i_C + k_3 \cdot u_r \quad (1)$$

The corresponding sliding mode control circuit is shown in Fig.7, without the forth term.

Equation (2) defines a sliding surface in a two dimensional state space, thus making the equivalent first order system,

$$s(u_C, i_C) = 0 \quad (2)$$

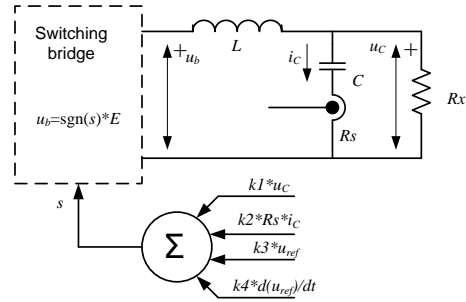

Figure 7. The equivalent control circuit of the single phase voltage inverter [4]

Taking into account that magnetizing current is much smaller than inverter current, the only care which must be taken is to prevent the transformer saturation. The magnetizing inductance can be neglected. To avoid saturation it is necessary to control the sum of the inverter output voltage  $u_C$  and the DC level of the bridge voltage  $u_L$ . On such way an accurate and reliable zero level DC voltage control is achieved.

According to [2], under assumption that reference voltage is equal to zero, the output voltage will approach the reference on an exponential way (3), where  $RS$  is the current sensor gain,

$$u_r(t) = 0 \Rightarrow u_C + R_S C \frac{du_C}{dt} = 0 \quad (3)$$

But in the case that reference voltage is sinusoidal (4) there exist a steady state error defined by equation (5)

$$u_r = A \cdot \sin(\omega t) \quad (4)$$

$$u_C + R_S C \cdot \frac{du_C}{dt} - u_r = 0 \quad (5)$$

The practical consequence of that steady state error is the existence of the phase difference between the output voltage  $u_C$  and reference voltage  $u_r$ .

To overcome that drawback it is necessary to introduce the certain modification in the sliding mode equation (1). By introducing the voltage error as defined in (6), the error equation is (7),

$$e = u_C - u_r \quad (6)$$

$$e + R_S C \cdot \frac{de}{dt} + R_S C \cdot \frac{du_r}{dt} = 0 \quad (7)$$

Again, the steady state error can be more clearly seen from equation (7).

In order to improve control, the necessary modification of sliding mode equation (1) is given as equation (8),

$$s(t) = k_1 \cdot u_C + k_2 \cdot i_C + k_3 \cdot u_r + k_4 \frac{du_r}{dt} \quad (8)$$

By introducing the derivative of the reference voltage (the fourth term in (8)) and after appropriate adjusting values of constants, the equation (9) is derived.

$$u_C + R_S C \frac{du_C}{dt} - u_r - K_x \frac{du_r}{dt} = 0 \quad (9)$$

By proper adjusting the gain of the derivative of the reference voltage (10), the first order differential equation governing voltage error is derived (11),

$$R_S C = K_x \quad (10)$$

The error voltage time constant is determined by product  $R_S C$  taken from equation (11),

$$e + R_S C \frac{de}{dt} = 0 \quad (11)$$

The error response time constant can be chosen in wide range. The main limit in the sliding mode control is the finite value of the sliding function due to hysteric control. Due to this reason the switching frequency is bounded thus limiting the error response time constant.

#### IV. SIMULATION RESULTS

For the single phase voltage inverter with enhanced sliding mode control the extensive simulation is performed. The simulating circuit for SIMCAD tool is shown in Fig.8. In Fig.9 the transient response of the voltage error on load pulse is shown.

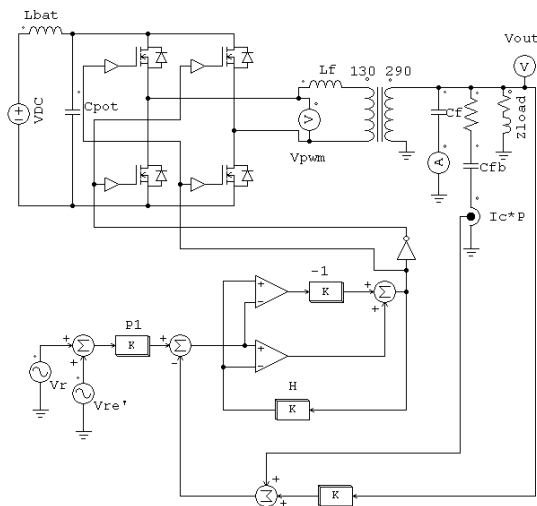

Figure 8. The simulating circuit of the enhanced sliding mode controlled voltage inverter

As it is seen in Fig.9 the voltage error has the exponential transient nature, while still exists certain small steady state error due to imperfect operation of the ideal power bridge and sliding mode control (the zero level of

sliding mode function is obtained via hysteric control, what leads to existence of small error). But, the overall error voltage is much smaller than in the classic case [1].

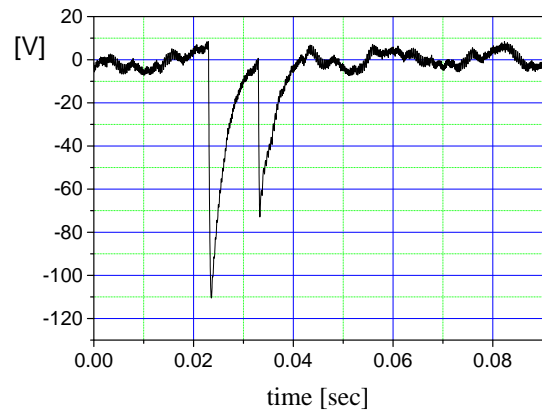

Figure 9. The voltage error in the simulated case with pulse load

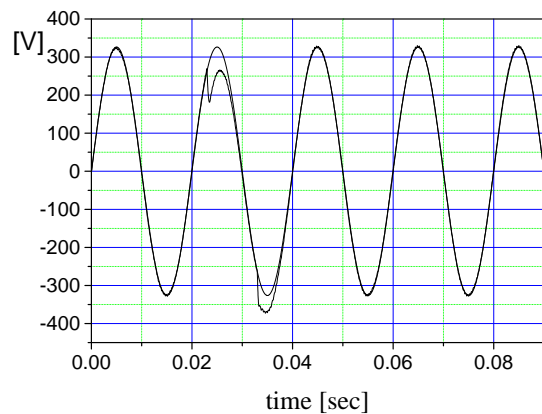

Figure 10. The reference and output voltage in the simulated case with pulse load.

In Fig.10 the simulated reference and output voltage waveforms are shown. It can be seen that a phase difference is very small. Also, due to applied load pulse there is one voltage dip at the rising edge of the load pulse. Also, there is the voltage overshoot at the falling edge of the same load pulse. Exponential nature of the voltage error is easily seen, due to parameters setting in such way to increase the error time constant, in order to make transients more obvious.

In order to compare the enhanced and classic sliding mode inverter voltage control, in Fig.11 and Fig.12 are shown output voltage and load current waveforms, recorded with inverter rated at 10 kVA loaded with step resistive load of 1.5 kW. The output voltage has regained sinusoidal waveform very fast, but there is oscillatory nature of the transient phenomenon, due to reason that condition (10) is not fulfilled. Applied sliding mode control is therefore similar to classic [2].

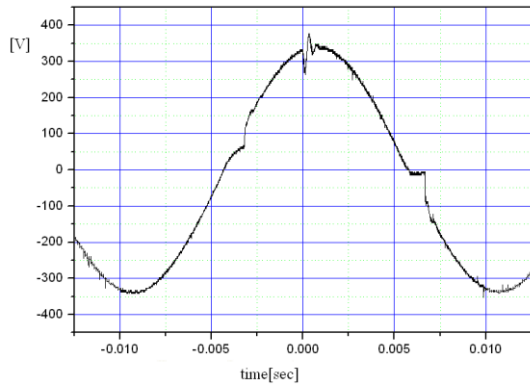

Figure 11. The recorded output voltage of 10kVA single phase inverter under the load current of Fig.12.

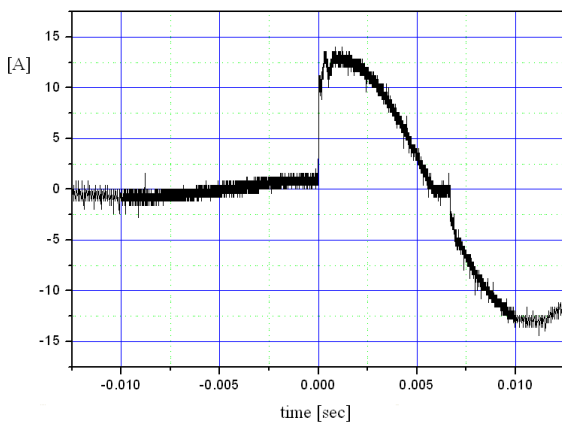

Figure 12. The recorded load current of a single phase inverter under the step of resistive load of 1.5 kW.

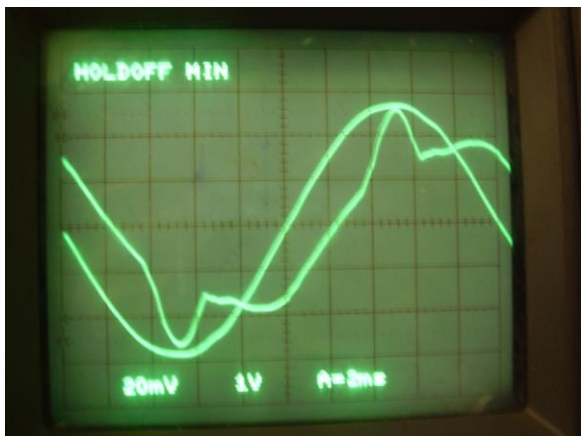

Figure 13. The recorded load current of a single phase inverter under the real load in thermal power plant TENTB. Voltage division is about 100V/div and current division is 17A/div

In Fig.13 it is shown another example of output voltage and distorted current of one inverter installed in thermal power plant Nikola Tesla B. The load is mainly composed of electromechanical relays and sophisticated modern digital protection devices. On such way the load

current is lagging and in addition there are spikes in waveform. Even under these conditions the output voltage has acceptable THD of less than 5%.

#### V. APPLICATION OF INVERTER CURRENT CONTROL USING DUAL CURRENT MODE MODULATOR

A modulator capable of automatically switching from switch-on mode to clock-pulse mode at  $D = 0.5$  (and vice versa), which enables stable control for all values of  $D$ , applicable to inverter control with all the good current control properties stored (constant switching frequency, automatic feed forward, automatic asymmetry correction, natural current limitation, simple compensation, excellent response to load changes and the ability to operate in parallel) and is called the dual current mode modulator [7]. His working principle is shown in the Fig. 14.

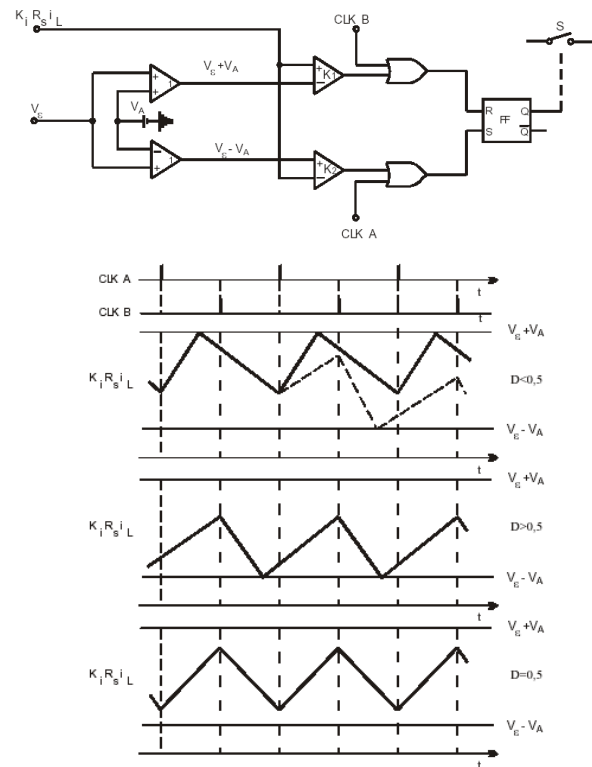

Figure 14. Schematic diagram of dual current mode modulator and three inverter modes [7].

In Fig. 14, three modes of converter operation are shown, depending on whether  $D < 0.5$ ,  $D > 0.5$  or  $D = 0.5$ .

When the slope of curve  $K_i R_s I_L$  changes (as a consequence of change  $U_{iz}/U_{ul}$ ), the modulator automatically changes mode (dashed line in the Fig. 14)

The inverter actuator is realized as a bridge of four switches (Fig. 1). The switch trigger pulses were obtained from one modulator, with the Q output RS FF being used to switch the switch in one and the other diagonal of the bridge. With this way of switching on, the bipolar pulses were obtained at the bridge exit.

Application of current control of inverters by means of so-called dual current mode modulator has remarkable dynamic characteristics. The sudden changes in load, which in the case of classical control methods cause significant leaks failures in the output voltage, are practically not felt in the converter units realized in this way (Fig. 15) [7].

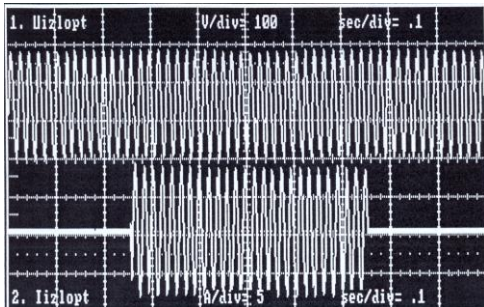

Figure 15. Effect of load change on output voltage[7]

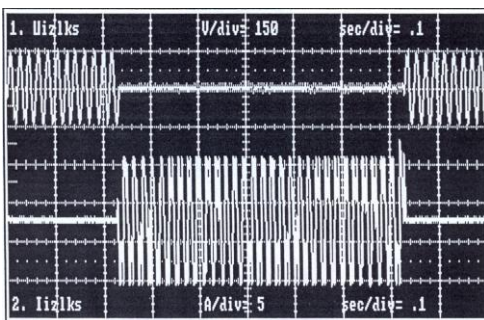

Figure 16. Output voltage and current at short circuit

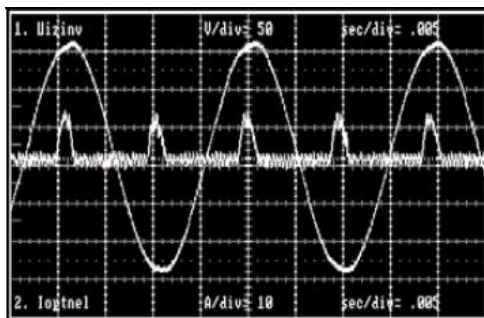

Figure 17. Inverter voltage and load current [7]

Another very important feature of electrically controlled inverters is the ability to operate at short circuit on the output (Fig. 16). Namely, the big problem of voltage sources (inverters), whether direct or alternating, is the problem of short circuit at the output due to their low internal impedance. However, if the control of the inverters is current, this control automatically translates the voltage source into a current that the short circuit at the output experiences as a natural mode of operation [7].

The output voltage of such a controlled inverter, loaded with nonlinear load, and the load current are given in Fig. 17.

It can be seen from the figure that the voltage of the inverter, loaded with a pulse current whose maximum is equal to the maximum of the rated current, is very little distorted, that is, it has a minimum THD, which is the result of the application of a very efficient control circuit.

Dual current mode modulator in addition to the UPS inverter control application, has excellent static and dynamic characteristics as well as the possibility of direct short circuit operation, extends the current control to four-quadrant converters that can be used for the realization of: reversible converters, active filters, inverters for three-phase motor control, PFC converter, DC motor control [7].

## VI. CONCLUSION

In this paper it is presented the enhanced sliding mode control of the single phase inverter output voltage. The modification of the classic sliding mode approach to the inverter voltage control is performed by introduction of the reference voltage derivative into sliding mode equation. On such way the output voltage error is exponentially approaching the zero and there is no phase difference between reference and output voltage. Such inverters can be connected to form the polyphase voltage system of greater voltage accuracy under different and/or asymmetrical load than before. Particularly prominent is the improved inverter control by the so-called. dual current mode modulators taken from the current literature, based on current control, based on output filter current control, which has all the good characteristics of current control (constant switching frequency, simple implementation, excellent static and dynamic characteristics, direct short operation capability compound).

## REFERENCES

- [1] D. Kostić, V. M. Šinik, "Approximate algorithm for determining pulse edges of a PWM inverter based on natural sampling", *Mathematical Problems in Engineering*, Hindawi Publishing Corp. (<http://www.hindawi.com>)
- [2] S.Vukosavić, "Comparative analysis of the inverter control algorithms with sinusoidal output voltage and weak voltage dependence of the load", MSc. Thesis in Serbian, Faculty of electrical engineering at Belgrade, 1987
- [3] S.Vukosavić, Ljiljana S. Perić, E.Levi, V.Vucković: "Reduction of the output impedance of PWM inverters in Uninterruptible Power Supplies", *Power Electronics Specialists Conf. PESC 1990*, pp 757-762
- [4] Ž. Janda, R. Đorđević, B. Jovanović, V. M. Šinik, "Enhanced Sliding-Mode Control of The Single Phase Voltage Source Inverter", *13. International Symposium on Power Electronics-Ee 2005*, November 2005, Novi Sad, paper No. T6-2.1, pp. (1-5).
- [5] P. Mattavelli, L. Rossetto, G. Spiazzi, P. Tenti, "General-purpose sliding-mode controller for DC/DC converter applications", *Proc. of IEEE Power Electronics Specialists Conf. (PESC)*, Seattle, June 1993, pp.609-615.
- [6] G. Spiazzi, P. Mattavelli, L. Rossetto, L. Malesani, "Application of Sliding Mode Control to Switch-Mode Power Supplies," *Journal of Circuits, Systems and Computers (JCSC)*, Vol. 5, No. 3, September 1995, pp.337-
- [7] M.Soja, S.Lubura, *Application of Current Control in DC / DC and DC / AC Converters*, V Symposium INDEL-2004. Banja Luka 2004-

# Power System Architecture for Servers Integrating Active, Passive and EMI-Filter Functions Design

V. Šinik\*, Ž. Despotović\*\*, D. Dobrilović\* and G. Gecin\*

\*University of Novi Sad, Technical Faculty "Mihajlo Pupin", Zrenjanin, Serbia

\*\*Institute "Mihajlo Pupin", Belgrade, Serbia

sinik.vladimir@gmail.com, boban@ieee.org, dalibor.dobrilovic@gmail.com, gorangecin@gmail.com

**Abstract** - At the beginning of the paper, the basis for the operation of the automatic uninterruptible power supply system is given. Power system architecture for servers with backup power based on to improve power density and efficiency on system level, are researched. Future generation servers are expected to operate with improved power architecture to achieve higher efficiency, power density, reliability and lower cost. This paper addresses the improvement of power processing technology through advanced integration of power electronics. The goal of a subsystem in a module necessitates this advanced integration, incorporating active switching stages, electromagnetic interference (EMI) filters, and electromagnetic power passives into modules by integration technology.

**Key words:** uninterruptible power supply, servers, integration technology.

## I. INTRODUCTION

UPS is the abbreviation for Uninterruptible Power Supply, and is a device which supplies power to devices for a fixed amount of time without stopping even when there are problems occurring with utility power and other power sources. In this present-day highly information-orientated society, the work tasks of many industries, including manufacturing, service and medical, operate on networks. For this reason, network system stoppages have an enormous impact on society and as such, the importance of UPS to provide these systems with a stable power supply is increasing [1].

In particular, the impact of system stoppages and malfunctions on systems which utilize computers and networks is immeasurable. UPS is essential to avoid this kind of power trouble and enable the stable operation of systems. Moreover, UPS enables power source management, such as the starting and stopping of network systems and the building of automated solutions.

When power failures such as power outages occur, computer devices such as servers and workstations may break down, leading to various problems such as the loss of important data and program malfunction. Moreover, even a momentary voltage drop on factory production lines, can result in system stoppages, defective products, and in the worst-case scenario, damage to equipment.

These issues can be avoided by installing UPS in computers, network systems, production lines, and the like and it is also possible to operate systems with stability and efficiency using the various functions of the UPS[1].

By connecting utility power to devices such as computers via a UPS, rather than directly, it is possible to supply stable power without fluctuation even if power outages or momentary voltage drops occur in utility power. By combining UPS with power source management software, it is possible to properly shutdown computers and other devices connected to UPS in the event of power outage. Moreover, when the power has been restored, the computers which were automatically stopped when the power outage occurred can be automatically started up again.

## II. OPERATING CONDITIONS OF THE SYSTEM FOR UNINTERRUPTIBLE POWER SUPPLY

Scheduled operation of turning UPS output on and off is possible once a day. (When UPS is off, computers will be automatically shut down). Fig. 1 gives an example of UPS system connection.

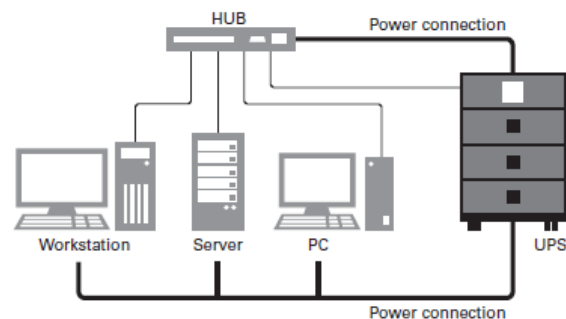

Figure 1. An example of UPS system connection [1]

UPS consists of the following circuits and the battery. In the event of a power outage or failure occurring in the AC input, the UPS continues supplying power from the batteries to the AC output.

(1) Rectifier: Circuit which converts AC power to DC power



- (2) Inverter: Circuit which converts DC power to AC power
- (3) Bypass: Circuit which directly outputs AC power
- (4) Switch: Circuit which switches between inverter output and bypass output

Figure 2 shows the basic structure of UPS.

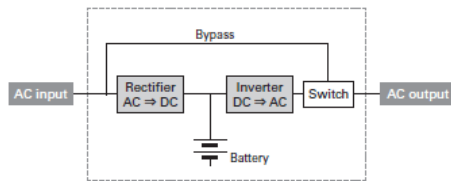

Figure 2. Basic structure of UPS [1]

A system of supplying power by converting AC input (utility power) to DC and reconvert it to stable AC by the inverter while constantly charging the batteries. Supplies power without momentary power breaks in the event of a power outage.

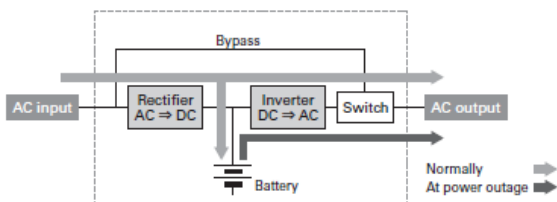

Figure 3. Online UPS

1) Standby UPS (Fig.4)

A system where, normally AC input (utility power) is output as is to connected devices and when a power outage or abnormal voltage is detected, inverter starts feeding using power from the batteries. In the event of a power outage, a few milliseconds of momentary break occurs in AC output.

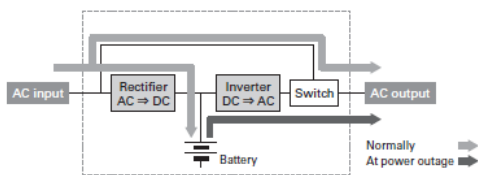

Figure 4. Standby UPS [1]

2) Parallel processing UPS (Fig.5)

While power from AC input (utility power) is supplied, the bidirectional inverter connected in parallel corrects voltage and absorbs noise. Because this is the online inverter (parallel) system, it has both high efficiency and high reliability.

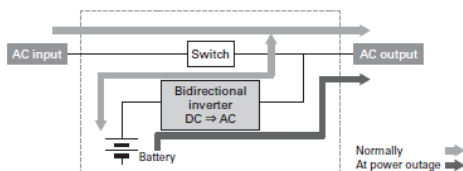

Figure 5. Parallel processing UPS

3) Hybrid UPS (Fig.6)

This system consists of three modes: double conversion mode, economy mode, and active filter mode. The UPS automatically selects the power feeding mode to best suit the power situation and load conditions. It is possible to shift between the respective modes with no momentary break in output voltage. Double conversion mode is selected when the power situation is poor and economy mode is selected when the power situation is good [1].

4) Parallel redundant operation system (Fig.7.)

Normally one unit operates in isolation, however by connecting two of the same units in parallel, it is possible to continue supplying power from one unit in the unlikely event that an error occurs on the other unit. This is referred to as the parallel redundant operation system. There will be a greater number of components than if only one UPS was used in isolation however reliability is notably improved based on the theory of a parallel system.

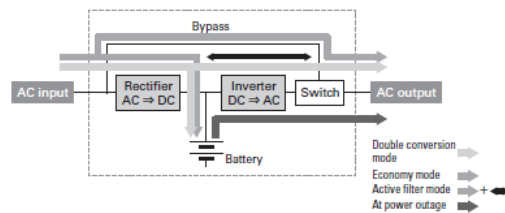

Figure 6. Hybrid UPS

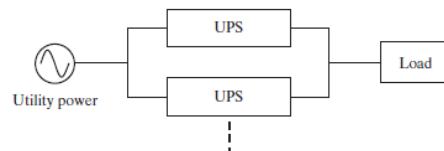

Figure 7. Parallel redundant operation system

III. EXISTING POWER ARCHITECTURE FOR COMPUTER SERVERS

Future generation servers are expected to operate with improved power architecture to achieve higher efficiency, power density, reliability and lower cost. So power system architecture, besides power converter modules, is attracted great research interest. An existing architecture of power supply for servers is shown in Fig.8. A UPS offers pre-regulated AC power from AC line or battery (through an inverter) in case the line dropout. Followed is a distributed power system (DPS) structure.

Where front-end(FE) converter consists power factor correction (PFC) converter modules, which converts the AC to 380Vdc, and isolated DC-DC converter modules, which transforms the 400Vdc to isolated 12Vdc intermediate bus (I-bus). And then several point of load (POL) converters deliver the power from the I-bus to distributed loads[2].

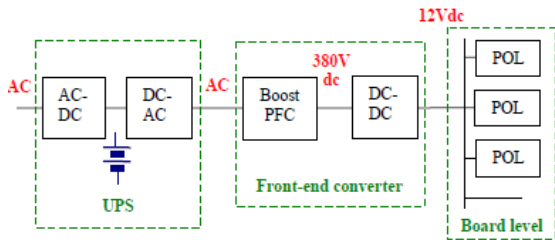

Figure 8. Existing power architecture for server [2]

In an existing power system, as shown in Fig.8, all of the UPS, FE converter and POL converters are now standard commercial products. But redundant power conversion really exists in the system.

At first, the PFC converter is designed to face wide ac input range with acceptable power factor. So the ac regulation by UPS unit is no longer necessary. Then the battery is supposed to be the backup energy, during ac line dropout, to power the server with much longer than required holdup time.

Furthermore, the dc output voltage of the battery is preferred to power the PE DC-DC converter directly than to go through the inverter and PFC converter.

As a result of power flow simplification, the UPS stage will be eliminated and the battery and FE converter will be merged with DC UPS performance, as shown in Fig.9

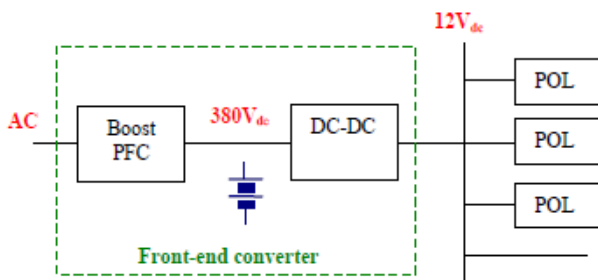

Figure 9. Simplified power system composition

From the point of POL converters, shown in Fig.8 and Fig.9, with various power level, output voltage and load specification, the universal intermediate 12Vdc bus, well regulated, is still challenged [2], [3].

#### IV. POWER ARCHITECTURES BASED ON HV DC BUS

Based on similar consideration, HV DC (high voltage DC) bus concept for server power system, as well as for telecom and data center, has been proposed and attracts great research interests [4]. It trend to build a distributed HV DC bus with lower current and higher efficiency with unwanted power conversion stages in conventional power system eliminated. The isolated DC-DC converters powered by HV DC bus are distributed on the board level[2], as illustrated in Fig.10.

On the other hand, nickel metal hydride (Ni-MH) battery, with much higher power density than conventional valve regulated lead-acid (VRLA) battery,

is expected to be engaged in server power system with cost drooping along with its wide application in hybrid power cars.

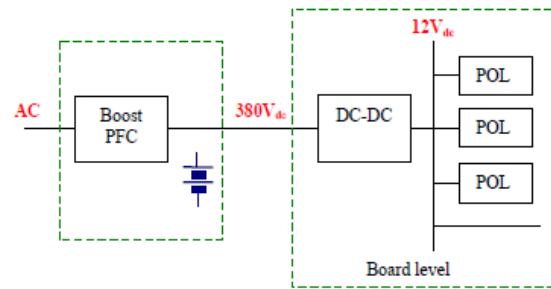

Figure 10. Power architecture with HV DC bus

It allows fast charging/discharging with high current [2]. The ways the battery cooperating with the HV DC bus will be discussed below.

#### A HV DC BUS ARCHITECTURE I

As shown in Fig.11, the battery operates with a special charger converter and discharge to the DC bus through a barrier diode, D. Known for the battery,  $V_b \text{ max}=1.25V_b \text{ rated}$ ,  $V_b \text{ min}=0.92V_b$  Then  $V_b \text{ rated}<304V$  is the guideline for design.

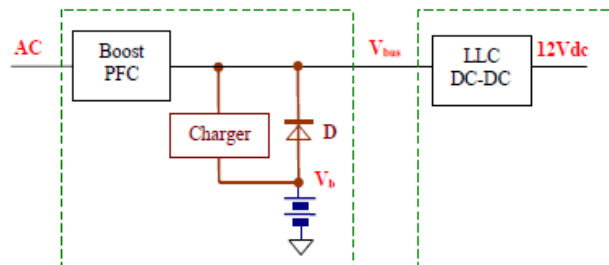

Figure 11. HV DC bus architecture I

It means the DC-DC converter will operate with an input voltage 380V, well regulated, at normal mode and a maximum voltage range from 380V to 276V at battery mode, as shown in Fig.12.

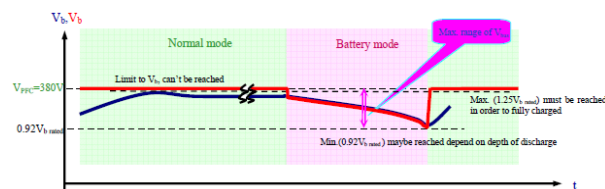

Figure 12. Operation mode and voltage [2]

#### B HV DC bus architecture II

In case fast recovery of the battery required, the power level of charging will be almost as high as discharging for the battery. A bi-directional buck-boost converter operates as a dual functional charger/discharger is preferred to ensure the HV DC bus a narrow voltage range. System diagram is given in Fig.13.

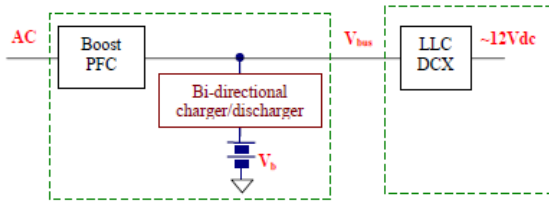

Figure 13. HV DC bus architecture II[2]

Terminal voltage of the battery, depending on numbers of the cells, is flexible with a discharger converter. The HV DC bus voltage,  $V_{bus}$ , is regulated within a narrow range. With a narrow input voltage range and followed by POL converters, the isolated step down voltage converter can be a non regulated bus converter, DCX, with higher efficiency and easier control than a DC-DC converter.

#### V. INTEGRATING ACTIVE, PASSIVE AND EMI-FILTER FUNCTIONS DESIGN

It has been argued for some time now that it is rather packaging, control, thermal management, and system integration issues that are the dominant technology barriers currently limiting the rapid growth of power conversion applications [5]. To address some of these issues, this part briefly discusses the technology advancement needed to improve the characteristics of power electronics systems, as well as the technologies being developed for integration of multi-kilowatt power electronics.

The technologies being developed will ultimately span a wide range of applications from distributed power systems to motor drives. This part also discusses results obtained from the various technologies being developed whose mission is to promote an integrated approach to power electronics systems in the form of highly integrated power electronics modules (IPEMs) [6].

#### A Integrated Switching Modules in Embedded Power

“Embedded power (EP)” refers to an integration technology, which was developed in-house for packaging power electronics switching (active) modules, incorporating multiple bare power chips, such as insulated gate bipolar transistors (IGBTs), MOSFETs, and diodes, and associated components for drive, control, and protection. Fig. 14(a) conceptually illustrates the cross section view of a power electronics module designed in this way. It consists of three layers: 1) base substrate; 2) EP stage; and 3) components, connected by solder layers.

In the structure, the EP stage—an integrated power chips component—is built on a flat ceramic frame, as shown in Fig. 14(b), with the chips embedded. The dielectric is used as an interlayer to protect the chip with defined vias on the top pads of the chips.

The metallization is for the interconnection of multiple power chips through metallurgical contact to aluminum pads on the chips through vias in the dielectric

layer; this replaces the bond wires in the conventional module, and is also used as the next-level interconnection for the attachment of associated components [layer 3 in Fig. 14(a)].

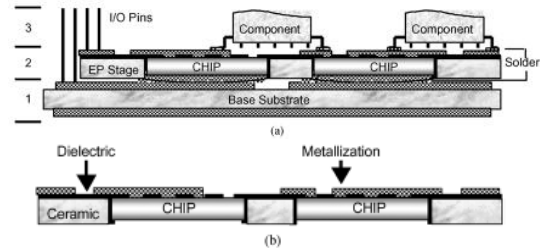

Figure 14. (a) Structural schematic of an embedded power module, (b) an integrated power chips stage [6].

Layer 1, the base substrate, can be a direct-bond copper (DBC) ceramic substrate for the bottom solder interconnects of multiple chips and also offers a thermal downward path. After stacking three layers by soldering, the structure offers several advantages, such as sandwiched bus layout, closer component attachment, shorter interconnects, and a solid construction[6].

#### B Integrated Electromagnetic Power Passive Modules

In order to integrate the electromagnetic power passive components used in power electronic converters into modules, additional technology had to be innovated. This integration technology for power passives can best be described by first considering a simple bifilar spiral winding as shown in Fig. 15(a). This structure consists of two windings (A–C and B–D), separated by a dielectric material. This resultant structure has distributed inductance and capacitance and is an electromagnetically integrated LC-resonant structure for which equivalent circuit characteristics depend on the external connections [Fig. 15(a)].

Even more complex integrated structures can be realized by adding more winding layers. This has been demonstrated with an integrated resonant transformer structure (L–L–C–T) as shown in Fig. 15(b) and (c). The necessary process flow for realizing these integrated structures are shown in Fig. 15(d) .

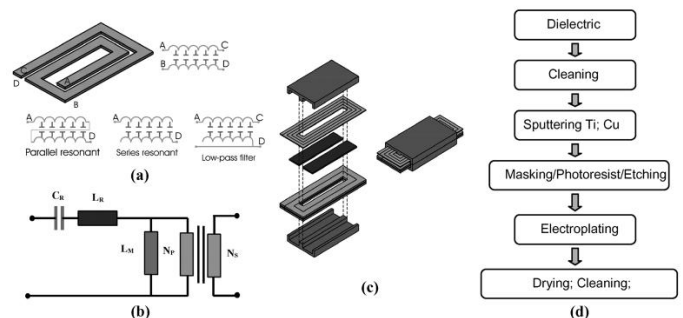

Figure 15. (a) Spiral integrated LC structure with distributed capacitance and possible external connection configurations, (b) simplified equivalent circuit, (c) exploded view, and (d) process flow.

C. Integrated EMI Filter IPEMs

Conventionally, EMI filters are implemented by using discrete components. The schematic of a typical EMI filter is shown in Fig. 16. Some problems for discrete EMI filters exist, however.

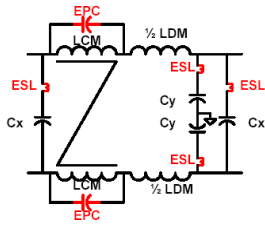

Figure 16. Schematic of a typical EMI Filter [7].

First, because of the existence of the detrimental parasitic parameters of the discrete passive components, such as the equivalent parallel capacitance (EPC) of the common mode chokes and the equivalent series inductance (ESL) of the capacitors, the effective filter frequency range is normally limited to a few megahertz. Second, the parasitic parameters caused by the filter layout will further affect the filters' high frequency performance detrimentally, so the EMI filter layout design always needs careful attention and it needs special expertise and experience. Third, the discrete EMI filter consists of a number of components. They must be processed differently and they are functionally and structurally separated.

In order to improve high frequency characteristics of integrated EMI filters, specific technologies need to be developed, which include technologies to reduce EPC, reduce ESL, and increase HF losses[6]-[7].

The cross-section of an integrated EMI filter with staggered and interleaved spiral windings is shown in Fig. 17. Only half a winding window of the planar EE core is shown in Fig. 17 to illustrate the structure. The designed preliminary integrated EMI filter has the same function as the discrete baseline filter, but higher power density, lower profile and similar or better HF attenuation.

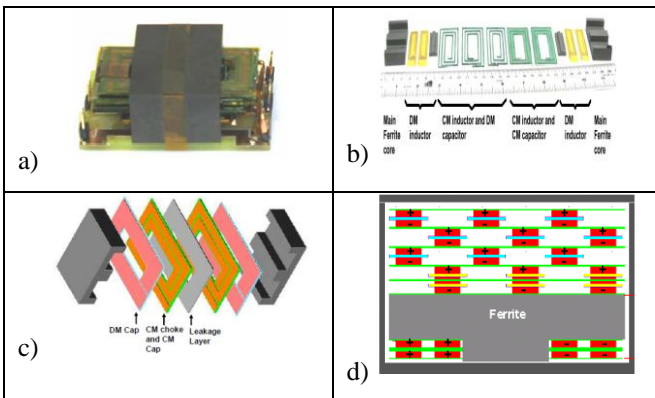

Figure 17. Integrated EMI filter structure: (a) overview, (b) exploded view cross section view of half winding window, (c) physical structure, and (d) exploded view cross section view of half winding window [7].

VI. INTEGRATED UNINTERRUPTIBLE POWER SUPPLY USED IN COMPUTER APPLICATIONS

DPS (Distributed Power System) are widely used in telecommunication and computer applications, and is the standard architecture for power distribution. The structure of a typical DPS is shown in Fig. 18. In present industry applications, discrete devices are used to construct the whole DPS system, including the power stage, associated control, sensing, and gate drivers. Since the system construction requires discrete components, it is difficult to optimize space usage and to further increase the system power density. The end objective is to integrate the functions and components for both the PFC and dc/dc converters shown in Fig. 18 With discrete device technology, the minimum structural inductances that can be achieved are defined by the individual device packages. Although these are reduced, they still generate extra non negligible switching loss at high switching frequency. To further minimize the inductance of the critical paths, the only solution is by seeking integrated approaches for power devices and components.

The realization of an integrated power electronics system requires advances in technologies, which depend upon solutions to deal with the multi-disciplinary issues in materials, electromagnetic compatibility and thermal management. The end objective is to integrate the functions and components for both the PFC and dc/dc converters shown in Fig. 18. Fig. 19 identifies the three blocks as an EMI filter IPEM, an active integrated power electronics module (active IPEM) and a passive integrated power electronics module (passive IPEM) [6]-[7].

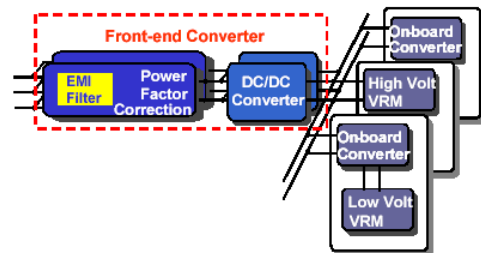

Figure 18. Distributed power system

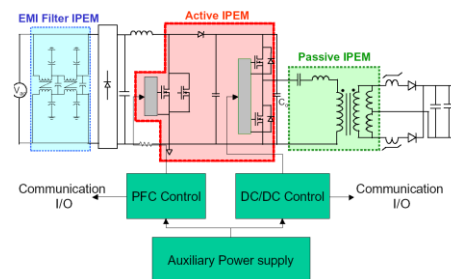

Figure 19. DPS-System with EMI Filter IPEM, PFC front-end asymmetrical half-bridge dc/dc converter (AHBC) as active IPEM and passive IPEM.

The active IPEM represents the integration of power MOSFETs and gate drivers, for both the PFC and dc/dc stage. The main goals of the overall integration are to

reduce the component count, increase power density, develop a modular approach, improve thermal management, and reduce the overall number of interconnections at the system level.

To demonstrate the benefits of the IPEM concept at the system level, two 1-kW front-end ac/dc converters were built using exactly the same topologies, one using discrete devices and the other one using IPEMs. As shown in Fig. 19, the system is constructed in two stages: PFC and dc/dc stages. The asymmetrical half bridge operating at 200 kHz was used for the dc/dc stage, since the primary side switches can easily achieve ZVS. The hardware for the two converters is shown in Fig. 20 [6].

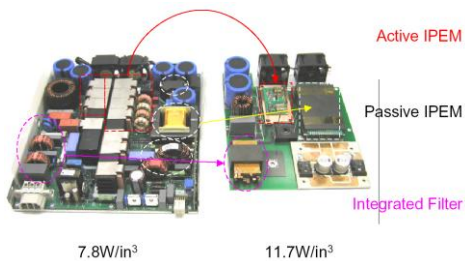

Figure 20. Comparison of the hardware of discrete and integrated DPS system: (a) discrete devices DPS and (b) IPEM-based DPS

By using integration, the density and the form factor of the active and passive devices are appreciably improved. Consequently, the system level power density of the converter improved dramatically. For the discrete approach, the power density was 7.5 W/in, while for the IPEM-based converter, the power density can be as high as 11.4 W/in with still much room for improvement.

By replacing the discrete active and passive devices, by IPEM sub-assemblies, the whole system only consists of a few modules, which is well suited to automated assembly. Not only has the system structure been improved, but the system electrical performance has been improved as well. As shown in Fig. 21, the system efficiency increases more than 2% at the high line voltage range, and more than 3% at 90V, simply by using the active and passive IPEMs.

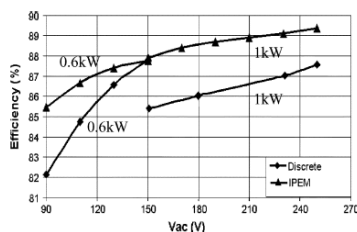

Figure 21. Efficiency comparison between IPEM and discrete approaches for DPS front-end converters.

Since the conduction loss of the active IPEM is approximately the same for the same operating conditions, the major improvement is in switching loss reduction by minimizing the structural inductances [6].

## VII. CONCLUSION

There are several alternate ways to improve system efficiency, power density and cost for the power delivering system with backup power for servers. The system can be compressed from conventional structure composed with separated UPS and distributed AC-DC power by eliminating redundant conversion stages and connecting the battery to the HV DC bus. And the characteristics of the bus depend greatly on the design of the battery charging/discharging. These novel integration and packaging technologies, in conjunction with suitable devices, sensors and integrated design tools used to exploit the physical properties of available materials. This paper has discussed some of these integration and packaging technologies and illustrated their advantages. The role of the technologies mentioned above in the IPEM concept is key to achieving high levels of integration and to enable significant growth of the power electronics industry. It is evident that further innovations will be necessary as power densities increase. The impacts of system integration via IPEMs will enable a rapid growth of power electronics applications with reduced costs and design cycles that can be compared to the impacts in computer applications.

## REFERENCES

- [1] Tetsuo Suzuki, Basic Knowledge Regarding Uninterruptible Power Supply (UPS), SANYO DENKI Technical Report No.40 November 2015
- [2] Yan Xing, Shuo Wang, Ming Xu and Fred C. Lee, Power System Architecture with Back-Up Power for Servers, Virginia Polytechnic Institute and State University, Blacksburg, VA 24061 USA
- [3] Fred C.Lee, Peter Barboa, Peng Xu, Jingdong Zhang, Bo Yang and Francisco Canales, Topologies and Design Considerations for Distributed
- [4] D. Marquet, O. Foucault, G. Kervarrec, New Flexible Powering Architecture for Integrated Service Operators, proceeding of Intelec'05, pp575-580
- [5] J. D. van Wyk and J. A. Ferreira, "Some present and future trends in power electronic converters. Proceedings," *Proc. IEEE IECON Conf.*, vol. 1, pp. 9–18, Nov. 9–13, 1992.
- [6] J. D. van Wyk, F. C. Lee, Z. Liang, R. Chen, S. Wang, and B. Lu, "Integrating active, passive and EMI-filter functions in power electronics systems: A case study of some technologies," *IEEE Trans. Power Electron.*, vol. 20, no. 3, pp. 523–536, May 2005.
- [7] Rengang Chen, Integrated EMI Filters for Switch Mode Power Supplies, Thesis of Doctor of Engineering, November, 2004, Blacksburg, VA

# Web Application for Egyptian Hieroglyphs Dictionary

Z. Kazi, O. Eskić and B. Radulović

University of Novi Sad, Technical faculty "Mihajlo Pupin", Zrenjanin, Serbia  
zoltan.kazi@gmail.com, ogiliano@hotmail.com, biljana.radulovic66@gmail.com

**Abstract** – This paper presents a web application for Egyptian hieroglyphs dictionary. It was created at Technical faculty "Mihajlo Pupin" within the subject of Information systems. Functions of this software are translating words, phrases and whole sentences from hieroglyphs form into the Serbian language words. Gardiner code was used for describing hieroglyphic characters. Hieroglyphs dictionaries that work on the Internet are also presented.

## I. INTRODUCTION

The basic idea of hieroglyphs dictionary is not only to translate individual Egyptian hieroglyphic words into Serbian language words, but also whole phrases, sentences and even complete text written by hieroglyphics. Gardiner code was used for describing hieroglyphic characters. In addition, the dictionary contains a list of the hieroglyphic characters that are used commonly and those not so commonly used, sorted by the Gardiner coding system and reduced by groups similarity. [1]

Rest of the paper is organized in following sections: 2 - a short overview of hieroglyphs dictionaries that can be found on Internet, 3 - description of our web application with basic functions, 4 - application implementation in PHP/MySQL/HTML/CSS/AJAX languages, scripts and technologies, and 5 - conclusion section.

## II. HIEROGLYPHS DICTIONARIES ON INTERNET

Dictionaries, web sites and software in this area that can be found on Internet are:

- Hieroglyphs.net [2]
- Hiéroglyphes égyptiens [3]
- Dictionnaire Rosette [4]
- Egyptian Hieroglyphs Dictionary [5]
- Lexilogos [6]

Hieroglyphs.net [2] is an English-Egyptian dictionary, with following functions: English word or phrase, transliteration, using hieroglyph code, and hieroglyph image included for each entry. Browsing through the dictionary is possible with a letter in one of the index tables (English-to-Hieroglyphs or Hieroglyphs-to-English) with section containing words beginning with that letter. Dictionary has possibility to find words that begins with matching letter or contains, does not contain, is that word,

or ends with typed letters. This web site is shown on "Figure 1".



Figure 1. Hieroglyphs.net dictionary

"Hiéroglyphes Égyptiens" is a web site on French language for translating hieroglyphs to French. It has vocabulary and various functions for translation like search for words containing given signs, training in reading words, Gardiner classification, selection of signs, main biliteres (two letters), main trilateres (three letters), elements of grammar, suffix pronouns, dependent pronouns, etc. [3]

Project Rosette manages a dictionary that includes the following works: the Faulkner/Medjat, the Kings, the Queens, the Proper Names (under construction), Titles (under construction), the book Rosette, the gods, eulogy formulas, and the Faulkner/Medjat. The French version of the dictionary is the work of the association Medjat. It uses the lexicographical list of R.O. Faulkner's Concise Dictionary of Middle Egyptian with the permission of the Griffith institute. A good part of the entries has been verified and validated (writing, transliteration, translation) from books in French. [4]

Egyptian Hieroglyphs Dictionary [5], by W. Budge is a digitalized form of a book that was written in 1920 and published in London, UK. It has an index of English words, king list, geographical list with indexes, list of hieroglyphic characters, Coptic, Persian and Semitic alphabets. Geographical names are presented in Coptic, Greek, Hebrew, Assyrian, Syrian, and Arabic.

Lexilogos is a comprehensive set of resources for the study of the languages of the world. In translating Egyptian hieroglyphs it works with Gardiner code. It has a dictionary and transliteration for more than 50 languages, including Serbian, Slovenian and Croatian. [6]

### III. DICTIONARY DESCRIPTION

The home page of this web application contains main menu and search through three tabs: Gardiner's code tab, transliteration tab and translation, as it is shown on "Figure 2".

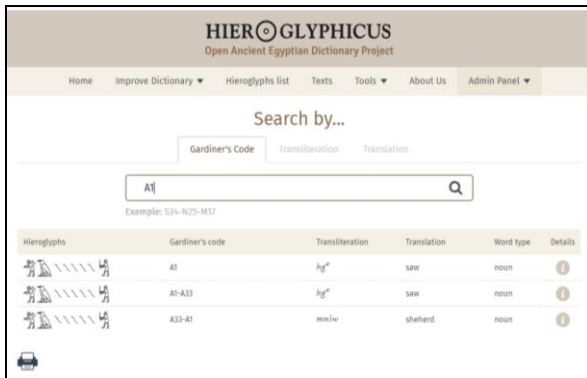

Figure 2. Dictionary main page

Central position on main page is reserved for search in these three categories. It is independent on each card. Users must first select the parameter for database searching. It can be done via the Gardiner's code tab, transliteration tab and translation (Translation tab).

The Gardiner code search is done in the format like in the following example: "A40B - M17 - M17 - Z7 - Y1 - A24 - A1 - Z2". After each part of the code that represents a single hieroglyph there is one single space character, than a minus sign (-) and a single space again. The transliteration search box contains a built-in special font. Search is done normally, typing into the search field the transliteration pronunciation of the requested word. The third way of searching is by translation. Searching through the Gardiner code or translation is not affected by large or small letters, but the search is performed by strings. After transliteration, however, the search depends on the "font size" because the combination of keys such as shift + h does not give a lot of "H" but a completely different symbol is obtained, precisely because of the special font that is present.

Part of the application for entering new words gives us the ability to enter words („Figure 3“), phrases and whole sentences. The form on page for the word input is divided into three parts.

The first option that user must enter is the Gardiner's code of the hieroglyphic words that we want to add. The hieroglyphs preview automatically displays the .svg picture of hieroglyph that we have entered, if it exists in the database. If database does not contain the image a questionnaire symbol will be displayed. After entering all the fields and submit option, the new word information is sent to the temporary database from which the

administrator checks, corrects, approves or deletes the sent word.

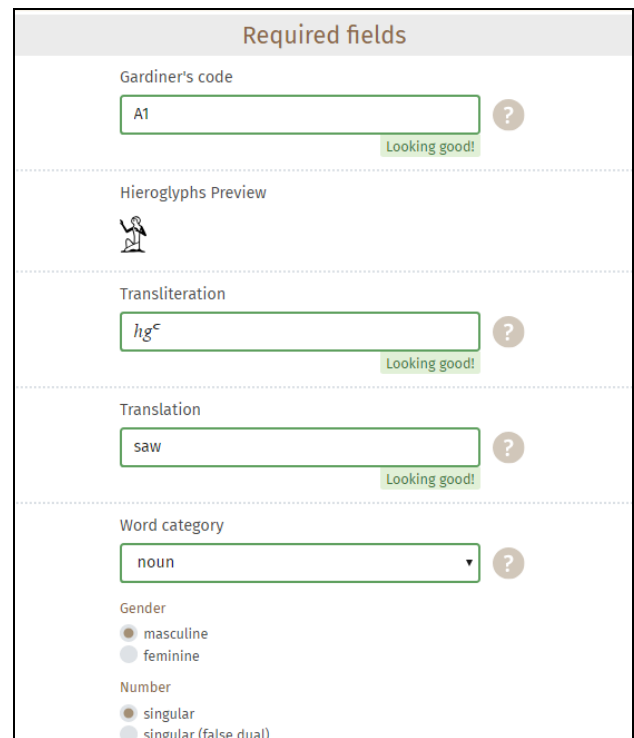

Figure 3. Web form for entering new words

Special attention should be done to the "word category" drop-down menu, where each selection from the menu provides new divisions (<div>), radio buttons and other options for the grammatical description of the word to be entered.

Part of the application for deleting user entries is intended for site administrators who have permission to decline, modify, or approve the entry of a new word. Manipulation with words can be done with „Accept all selected“ or rejecting via the „Reject“ options. Previously, it is necessary to check each desired checkbox, which is in the table first column. After "Accept all selected" option all stored rows are in the database will be deleted, while choosing the "Reject all selected" row or selected rows will be deleted only from the temporary database as it is shown on Figure 4.

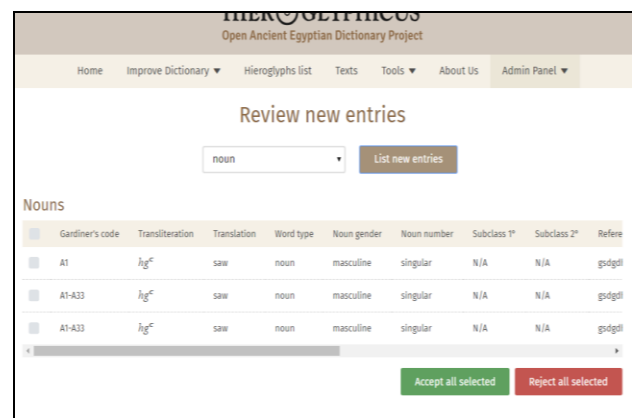

Figure 4. Admin panel for reviewing new words

#### IV. WEB APPLICATION IMPLEMENTATION

Software packages that were used are XAMP Control Panel, Visual Studio Code, and DB Designer. Programming languages for coding part are PHP and JavaScript. Other used technologies are HTML, CSS, jQuery/AJAX, and DDL and DML for SQL queries manipulation.

The most parts of the application are done in three-layer architecture. First layer is user interface realized through the HTML-rendered interface stylized in CSS, and the AJAX occasionally needs to retrieve data from certain fields, perform basic checks, and send data to the second layer done with PHP programming language, which performs more in-depth verification, connects, and communicates with the third layer in a form of relational database. DBMS system returns the query result to AJAX, which then fills the HTML elements with the result.

The four-tier architecture case was used as part of the search application. Since there are 3 search cards by three different criteria, HTML will only be displayed for Gardiner code search. It is fair to mention that the HTML code for all three searches is practically the same except for the field identifier (hereinafter: ID) for each input input.

Implementation will be presented with the most relevant part for searching words. After the entry of the Gardiner code activates an AJAX script called "searchFunctions.js" that has an input parameter "page" and does the following within the function: \$ .ajax method is started, which is similar to the \$ .post method only \$ .ajax allows us to choose whether the method for sending information will be over global variables \$ \_GET or \$ \_POST. \$ .ajax has a handful list of parameters. In this case we need only three: url, method, and data. The URL parameter determines to which address the request will be sent and executed. The method parameter allows us to choose the basis on which we send data to an address, and finally the given parameter allows us to store the data we send to the address. The first parameter, page, refers to a variable page from PHP and the second from JS. In this case, at the beginning of the page parameter is nothing. The searchTermGardiner: searchTermGardiner function takes the input and sends it to PHP. Since AJAX is asynchronous, it will first wait for the server to respond to the client, and after that the function will continue to run through a property called success. If the response and sending were successful, the function with the data from the data executes and after execution we select the ID of the input where we return the processed data in the form of HTML code.

```
function searchGardiners(page)
{
$.ajax(
{
url : "includes/searchGardiners.script.php",
method : "POST",
data : {
page : page,
searchTermGardiner : searchTermGardiner
},
success : function (data)
{
$('#searchResultsGardiner').html(data);
}
});}
```

The addition to the PHP script is page numbering, because the application is designed to produce a maximum of five results per page after search. Since the problem was how to get the other five results when going to page two, three and so on, the following script was created, which is activated on the page that contains the link to the script we are analyzing, (in this case it is the initial index page) when clicking on the pagination\_link class:

```
$(document).on('click', '.pagination_link', function()
{
var page = $(this).attr("id");
searchGardiners(page, searchTermGardiner);
});
```

The result of executing SQL queries is presented in a sorted table that can be optionally printed or transposed into a PDF document. In order for the application to be friendlier to users, a click-to-click system is used into the image of the printer in the lower left corner that appears along with the result of the executed SQL code. The relational database was created using data definition SQL query language statements create database, create table, alter table.

Example of Select SQL query used in application retrieving data from database:

```
$sql = "SELECT
hgs_transliterations.transliteration,
hgs_gardiners_hieroglyphs.gardiners_code,
hgs_gardiners_hieroglyphs.hieroglyphs,
hgs_meanings.meaning,
hgs_word_types.word_type,
hgs_references.reference
FROM hgs_translations JOIN hgs_transliterations
ON hgs_translations.transliteration_id = hgs_transliterations.id
JOIN hgs_gardiners_hieroglyphs ON
hgs_translations.gardiners_id = hgs_gardiners_hieroglyphs.id
JOIN hgs_meanings ON
hgs_translations.meaning_id = hgs_meanings.id
JOIN hgs_word_types ON
hgs_translations.word_type_id = hgs_word_types.id
JOIN junc_translation_reference ON
junc_translation_reference.translation_id = hgs_translations.id
JOIN hgs_references ON
hgs_references.id = junc_translation_reference.reference_id
WHERE gardiners_code LIKE ?";
```

Checking the validity of the entered data and changing the style of the error-containing fields is listed below. If there is an error, the user is redirected to the part of the page with the first error in the sequence.



Variables are defined to check the spelling errors and to store the values from programming elements from other parts of this page done in JavaScript:

```
// Noun error variables
var noNounInputError = false;
var noNounGenderError = false;
var noNounNumberError = false;
// Noun variables
var nounGenderValue = $("input[name='noun-gender']:checked").val();
var nounNumberValue = $("input[name='noun-number']:checked").val();
var nounSubclass1Value = $("#js-subclass-primary-selector").find("option:selected").prop("value");
var nounSubclass2Value = $("#js-subclass-secondary-selector").find("option:selected").prop("value");
// Noun checkers
if (inputWordCategoryValue == "noun") {
// Check if noun gender is checked
if (!nounGenderValue) {
$(".radio-validation-message-div").css("display", "flex");
$(".noun-gender-label").css("color", "rgb(170,70,65)");
var errorMessage = "<div class='radio-error-message error-pointer'><p>Please, select noun gender.</p></div>";
$("#js-noun-gender-error-div").html(errorMessage);
noNounGenderError = false;
} else {
$("#js-noun-gender-error-div").empty();
$(".noun-gender-label").css("color", "rgb(77,77,77)");
noNounGenderError = true;
}
}
// Check if noun number is checked
if (!nounNumberValue) {
$(".radio-validation-message-div").css("display", "flex");
$(".noun-number-label").css("color", "rgb(170,70,65)");
var errorMessage = "<div class='radio-error-message error-pointer'><p>Please, select noun number.</p></div>";
$("#js-noun-number-error-div").html(errorMessage);
noNounNumberError = false;
} else {
$("#js-noun-number-error-div").empty();
$(".noun-number-label").css("color", "rgb(77,77,77)");
noNounNumberError = true;
}
}
// Remove errors when noun gender is checked
$("#input[name='noun-gender']").change(function(){
$("#js-noun-gender-error-div").empty();
$(".noun-gender-label").css("color", "rgb(77,77,77)");
});
// Remove errors when noun number is checked
$("#input[name='noun-number']").change(function(){
$("#js-noun-number-error-div").empty();
$(".noun-number-label").css("color", "rgb(77,77,77)");
});
// Check if subclass(es) are selected
if (nounSubclass1Value == "") {
$("#js-subclass-primary-selector
option[value='N/A']").prop("selected", true);
}
if (nounSubclass2Value == "") {
$("#js-subclass-secondary-selector
option[value='N/A']").prop("selected", true);
}
if (noNounGenderError == true && noNounNumberError ==
true) {
noNounInputError = true;
} else {
noNounInputError = false;
}
}
```

## V. CONCLUSION

Creating a web application in dictionary area for a complex language such is Egyptian hieroglyphics was a really serious and demanding task that could not be done without a specific knowledge from the subject area. It can be concluded that there is a limited and small amount of literature available on the Internet in this area and it has not been explored enough. There are several web sites that can work with hieroglyphics and they have served as a reference and source for creating this web application which is not yet fully completed and can be upgraded in the future with tools, tests, etc.

Strength of this application is openness to the world, users can participate; add new words, images, and bibliographic sources. Future work will consider adding grammar for all ancient Egyptian languages and appending database with phrases and more text.

## REFERENCES

- [1] J.P. Allen, "An Introduction to the Language and Culture of Hieroglyphs", Vygus dictionary, 2012, <https://www.pyramidtextsonline.com/MarkVygusDictionary.pdf>.
- [2] Hieroglyphs.net, <http://hieroglyphs.net/cgi/pager.pl?p=16>.
- [3] Hiéroglyphes égyptiens, <https://www.hierogl.ch/hiero/Accueil>.
- [4] Dictionnaire Rosette, <http://projetrossette.info/page.php?Id=599>.
- [5] W. Budge, Egyptian Hieroglyphs Dictionary, London, 1920, <https://archive.org/stream/egyptianhierogly01budguoft#page/n6/mode/2up>.
- [6] Lexilogos, <https://www.lexilogos.com/keyboard/hieroglyph.php>.

# Life-long Learning - Motivation of Company Employees to Attend On-line Training

D. Glušac\*, D. Veselinov\*\* and D. Milanov\*

\*University of Novi Sad, Technical Faculty „Mihajlo Pupin“, Zrenjanin, Republic of Serbia

\*\* Naftna industrija Srbije a.d. Novi Sad

glusacdragana.zr@gmail.com, dejanov.nallog@outlook.com, dusanka.milanov@gmail.com

**Abstract - Vocational or training courses, both traditional and by using online learning platforms, are becoming more commonplace in the company environment, with the goal of developing and eventually increasing employee productivity. Employees are offered training through internal or external training. Internal training is conducted by employees who work in the company, have the necessary qualifications and competencies that are narrowly professional and often gained by experience. This paper investigates whether employees are motivated to attend company training and whether certain types of training and training methods have an impact on training outcomes, that is, whether there is a statistically significant difference in employee attitudes towards traditional and online training. The aim of the research is to find the optimal way to create the content of future trainings, using different methods of presenting content, which would lead to the increase of employees' motivation to attend company training.**

## I. INTRODUCTION

Due to the constant changes in the market, companies, in order to keep up with the competition and stay on top of successful companies list, significantly invest resources in the continuous education of employees, in order to increase the competencies and skills of employees.

It would be ideal for any company to have the employee training process effective, with a realistic outcome of results and time-limited, so that employees do not take much time off from their day-to-day responsibilities and do not jeopardize the ongoing work process.

Learning is a complex process that involves the acquisition of habits, knowledge and skills. The process leads to the end result of remembering the received information. Learning and memorizing are two complementary aspects of the learning process.

Keeping in mind the definition of learning, it is a difficult task for companies to transform the transfer of positive practice in the form of information and practical skills, to achieve the ultimate goal of remembering activities and, ideally, to apply the acquired knowledge.

Another factor that significantly affects the performance of employees is motivation. Motivation encourages activity, which is intensely directed and has a definite duration. Motivation fosters willpower, which is crucial, because if left out and dealt with in a negative attitude, over time it leaves a mark on the personality and psychological insecurity.

“Reflex-based learning is most commonly used as the lowest type of learning. This is followed by learning by trial and error. In other types of learning, thinking becomes more and more likely, when assuming and noticing the connection of a situation to an activity as a consequence (“reaction”). In this regard, the next type is learning a series of situations and activities. In this type of learning, “meaningful learning” is increasingly expressed as more valuable and more effective than “mechanical” learning”. [6,7].

## II. ANALYZING NEEDS WHEN CREATING TRAINING

When creating training, several things must be taken into account, such as the quality, amount of information, time, groups of trainees, the type of training and the costs that will be required to train employees.

The quality of training should, as the ultimate goal, provide employees with gaining new perspectives, insights, awakening their desire to be further informed about the topic and of course, knowledge.

The amount of information must be clearly demarcated and it depends on whether it is compulsory training, technical or “soft” employee development training. If the change in dynamics can be achieved by designing content that, along with descriptive presentation, follows appropriate examples, case studies, and problem-solving methods, it would greatly help readers to easily adopt the content. Generally, if there is interaction with readers, using content delivery methods, it will be easier to master the content of the training that is intended to be delivered.

By “type of training” it is meant whether it is compulsory training, technical training or the development of so-called “soft training” skills. In the case of statutory and technical trainings, they are generally based on a well-defined schedule of topics that would be desirable to address, and here the emphasis of the training objective is on enhancing the competences of skills and knowledge in a particular field. With soft training or development training, the goal is to broaden perspectives, develop thinking and attitudes for the personal development of the individual. With this in mind, the content of the material itself needs to be clearly designed in order to achieve a specific goal.

The dynamics of a group can be seen as more closed or more open. Closer groups occur in most cases, when people gather for instruction-based training, that is,

successful “steps” in solving a particular topic or problem lead to a goal. In this case, each individual pace strives for the most efficient solutions. A more closed group in soft training may also occur if the participants are more introverted, or the moderator failed to establish enough closeness with the group he is working with, or did not give a sufficiently good answer to the question asked and thus lost credibility with the group. More open groups, at the very core, are based on interactivity between participants, mostly seen in "soft training" that encourages communication and collaboration between members. There are “breaking the ice”, “empowering the group” activities that are recommended and make sense in case the participants are not familiar with each other, in order to gain freedom and the confidence of sharing with the group in a relatively short time. If instructional training is conceived as working in pairs and sharing knowledge, then the dynamics of the group in these types of training increase significantly.

The duration of the training is much more precise in the implementation of statutory training and in technical training. These trainings are followed by clearly defined instructions that lead to the achievement of the goal. "Soft" or developmental training, have a more flexible approach, because they depend largely on the interaction in the group and their experiences. From this it is clear that, even if there is an agenda on how to guide soft training, this can be greatly altered by the events occurring during the training itself and the unforeseen time spent on the topic within the group.

### III. RESEARCH OF EMPLOYEE MOTIVATION FOR ONLINE TRAINING

#### A. *Defining the subject, problem and goal of the research*

Company trainings, both traditional and using online learning platforms, are a growing occurrence in the company environment, with the goal of developing and eventually increasing employee productivity. Are employees motivated enough to attend company training and whether a particular method of presenting learning content has an effect on performance in both traditional training delivery and online training?

The subject of the research is the motivation of employees and whether certain methods of presenting content can influence the creation of future course content and how much they influence the overall success of the training.

The aim of the research is to find the optimal way to create the content of future trainings, using different methods of presenting content, which would lead to the motivation of employees to attend company trainings. Due to the small number of respondents, research can be classified as micro-research.

The collected data can encourage the review of previous activities, the initiation of new activities, with the aim of reviewing opportunities and new forms of developmental education of employees in companies.

The tasks of the research are:

- Determine aspects of employees regarding their views on in-company personal development,
- Determine the aspects of employees in terms of the methods used for displayed training content,
- Find out which training method is most useful for employees in applying knowledge in their daily work.

To test the hypothesis and the auxiliary hypothesis, we use the following methods:

- Descriptive method - used to analyze the parameters of the introduction of an electronic form of learning,
- Empirical method - a survey of employees was conducted,
- Comparative method - Comparison of traditional training of employees with electronic form of knowledge acquisition,
- When presenting the results, a descriptive statistical method was used,
- A T test analysis was also performed.

#### B. *Research Hypotheses*

H0: Employees are motivated for available online trainings.

The auxiliary hypothesis is:

H1: Training Method - "Simulation" is most effective in presenting information in online training and has the greatest impact on employees.

From March to May 2019, a staff survey was conducted that included 30 employees attending the traditional form of one-day training consisting of a variety of activities, both individual and group. After the results were obtained, the author had the initial knowledge for creating online training on the Moodle platform to get additional results, consisting of 28 respondents, which would help to create new trainings and to design their content.

### IV. RESULTS OF THE RESEARCH

#### A. *By surveying of traditional teaching*

After the company training was finished, which was conducted in the traditional way and using different methods, aimed at improving interaction with participants and sharing experiences, a survey was created which was anonymous and was given to employees after the training was completed.

The survey consisted of questions and the answer options were the following: Extremely, Mostly, Not particularly, Not at all.

**B. Data processing by fields of interest**

- The analysis of responses related to the motivation to attend online training

Descriptively presented data indicate that employees are generally motivated, but by only 43% of employees prior to attending online training. 43% confirmed that they were fully motivated before training. Compared to the traditional way of attending training, where 53% of the surveyed employees are mostly motivated, while 33% of the respondents are extremely motivated, we can give a slight advantage to online training in terms of motivation of employees to attend it.

The next question was related to satisfaction after online training, where 21% of employees mostly agreed to it and 68% of employees generally agreed. Regarding the data obtained through the survey after completing traditional training, 37% of employees mostly agreed and 63% of employees, in general, agreed. Here, in both cases, we can see that satisfaction is at a high level, but it should be noted that 4% of employees are not particularly satisfied with attending online training, which can be an initial starting point for ways to change in the future when creating new online training.

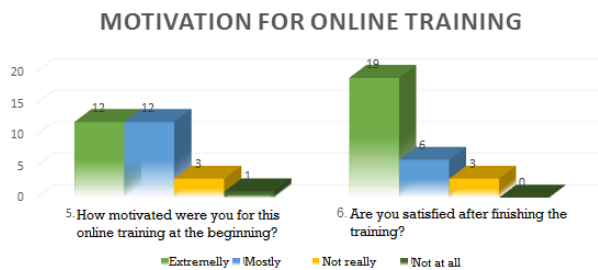

Figure 1. Graphic view of motivation for online training



Figure 2. Graphic view of motivation for traditional training

- Analysis of responses related to the impact of different methods of content presentation in order to gain knowledge

Through the scale already known, employees answered questions about how much different methods presented to them, actually helped them to adopt the presented information more easily.

The data revealed that simulation method mostly contributed to the acquisition of knowledge, and according to 25% of employees, it was information gained via pictures with 32%, via video with 43% and that the

case study methods had an impact with 62%. 68% of employees said that presentation of information via the picture was important by 61%, followed by the video clip with 50%, while the case study method was evaluated with only 33%. The method of case study in online training was assessed as not important for 5% of the employees surveyed. This is interesting data because it was found to be extremely useful with 57% of employees when interviewing them after completing traditional training, and it was the highest score of all of the other methods offered in traditional training delivery.

- Analysis related to determining the future needs of employees in the creation of training content

Continuing the research, along with information of motivation and the opinion of the employees which method gave the highest results, the ways of presenting the information that employees would like to see when attending the training are determined. Options are given for employees to decide whether they would like to research independently, from the given material and documents or by using already prepared content in the form of video material. The employees voted 50% for each. This test provided an even more accurate scale in which employees would answer the question on a scale from 1-10, in order to obtain as detailed information which would be used in preparing future training content for individual users. Minimum grades got the method were they would find the material themselves.

- Analysis related to the quality of the presented materials of created online training

The online training participants were also asked questions about the quality of the presented content, which could greatly help in both the future content creation and the employees' views on the benefits of the presented methods. Based on the results presented, we note that simulation with 64% got the highest score, slightly ahead of image demonstration with 57%, is followed by video content with 50%, while the case study has the lowest rating with 39%. It can be stated that the content creation and interest that arouses with the trainees can significantly influence the outcome of information acquisition, which this research confirmed.

**C. T test analysis**

The t test statistical method serves to prove whether there is a significant difference between the 2 groups, or the data set being compared.

By using T test analysis we wanted to check whether there was a significant discrepancy between trainees' motivation prior to training, whether traditional or online training. The results of the analysis related to attendance motivation before traditional and online training were taken. From a total of 30 samples collected in traditional training and 28 samples from online training evaluation, we obtained the following results, using a significance level  $\alpha = 0.05$ :

By the obtained values of P, which is 0.46471056 and since it is less than the significance level  $\alpha = 0.05$ , we find that there is a statistically significant difference between

the two mentioned data sets. This claim is confirmed by the value of  $t$  Stat, which is 0.736244575 and since it is greater than the significance level  $\alpha = 0.05$ , we obtain confirmation of the previous claim that statistically there is a significant difference between the two mentioned data sets.

Also, with the T test analysis we wanted to check if there was a statistically significant difference between the motivation of the trainees of traditional and online training after it was completed. The results of the analysis related to the motivation to attend after traditional and online training were taken. From a total of 30 samples collected in traditional training and 28 samples from online training evaluation, we obtained the following results, using a significance level  $\alpha = 0.05$ :

The obtained values of P, which is 0.803846785 and since it is greater than the significance level  $\alpha = 0.05$ , we find that there is no statistically significant difference between the two mentioned data sets.

This claim is confirmed by the value of  $t$  Stat, which is 0.249552212 and since it is less than the significance level  $\alpha = 0.05$ , we get confirmation of the previous claim that there is statistically no significant difference between the two mentioned data sets.

#### *D. Observation of obtained research results*

The research that was conducted investigated the motivation of the employees in both the traditionally conducted trainings and the online training created on the Moodle platform. Also, the field of interest of this research was to discover which method proved to be the most effective when conducting the two types of training mentioned. The subject of the research is the motivation of employees and whether certain methods of content presentation can influence the creation of future course content and how much they influence the overall success of the training. The aim of the research was to confirm (or otherwise to refute) the hypothesis: employees are motivated to conduct online training.

During the survey, a survey was first conducted with employees on traditionally conducted training that lasted one day. The training itself used training methods that included video, a case study, participant interaction through assigned problem solving, and a descriptive method. After evaluations were processed, it turned out that employees were poorly informed about the topic before the training. Also, the training leader was not aware of the needs of the trainees themselves and their learning styles, and this can in many ways affect the very outcome of the training in terms of employee motivation and satisfaction.

Using the lessons learned from the evaluation presented, a short online course was created, which with already prepared material, using different training methods, would lead to the possible improvement and expression of the employees' satisfaction and future needs when acquiring new knowledge.

When attending the online course and completing the questionnaires, employees were motivated to undergo the aforementioned training and did so at the time it suited

them, in accordance with other obligations. Since they were asked about their satisfaction after completing the online course, the result increased by 25% when comparing the item of complete satisfaction with the course.

The main hypothesis, which is that employees are motivated for online trainings conducted, according to the attitudes of employees obtained through completed evaluation after completing the online course and subsequently performed statistical T test analysis, was proved by the performed research.

The auxiliary hypothesis, which states that the method of presenting content as "simulation", is most effective in presenting information in online training and has the greatest impact on employees, has been proven by the conducted research.

The "Simulations" method slightly distinguished itself in the parameter examining knowledge acquisition when presenting information, in comparison to the methods of video recording and informing employees through pictures, but it was significantly different from the "Case studies" method, by 35%.

The "Simulation" method stood out and was best quoted in a parameter that referred to the quality of the content creation itself. The simulation method received the highest rating with 68%, then use of images were rated with 61%, the video clip with 50, while the "case study" was rated with 33%, in terms of complete satisfaction of employees.

When it comes to the results of the quiz, which is designed so that each method mentioned above has the same number of questions, where it could be determined the parameter of how well the employees had success in acquiring the knowledge, the following results were obtained. Demonstration method has a success rate of 62%, followed by the Simulation method with 54%, the questions related to the video watched, the employees answered correctly with 48%, while with 28% accuracy, the questions from the case study method.

#### V. CONCLUSION

Companies that strive for development, competitiveness and sustainability should give the opportunity of professional development to their employees, in order to improve their competences and strive for professional development. Bearing in mind these facts and obtaining results by analyzing, the question arises as to how much material investment is required from companies in the professional development of employees.

According to some surveys (The Industry report, 2018), research was conducted on budgeting and training programs from smaller to larger companies in America. The survey was conducted from May to July 2018 based on information obtained from the e-mails of voluntary respondents. Only US companies with 100 or more employees participated in the analysis. 61% of managers, 17% of developers and 22% of middle and lower level interviewees responded to the survey results. The results of the analysis showed that an average of 11% of the total

budget is spent on employee training. Overall, the average cost was \$ 986 per employee. Medium-sized companies spent \$ 858, big ones 1046, and smaller companies \$ 1096 per employee. The strategic plan for the 2019 companies that responded to the survey is to increase the effectiveness of the training programs, measure the success of conducted trainings, and use the largest budget planned for the calendar year for managers and supervisors.

On the basis of all the facts presented, we see that in foreign companies funds are set aside for the purpose of developing an employee and that the results of conducted trainings and their impact on the business of the companies can be metrically presented.

In order to achieve the best possible result, new training methods are being developed, that aim to link the content of problem situations, expand levels of specific skills and lead to faster knowledge acquisition. The eventual success leads to strengthening of self-confidence and motivation of the employees while working. All of the above is also a goal of the educational process, so the constant and frequent training is essential for employees.

An important fact to note is the willingness of employees to acquire new knowledge. Changing work habits and principles leads to positive effects in the entire business process. If the employee does not apply the knowledge gained, the impact of training on the overall business result of the company is reduced.

#### REFERENCES

- [1] L. Argot, *Organisational Learning: Creating, retaining and transferring knowledge*, 2012, Springer.
- [2] Ž. Adamović, *Metodologija istraživačkog rada*, 2008, Tehnički fakultet „Mihajlo Pupin“, Zrenjanin
- [3] T. Bray, *The training manual*, 2009, Kogan Page
- [4] T. Bray, *The complete practical guide to creating effective and successful training programmes*, 2009, Kogan Page Limited, Second Edition
- [5] D. Glušac, *Elektronsko učenje*, 2014, Tehnički fakultet „Mihajlo Pupin“, Zrenjanin
- [6] V. Mužić, *Metodologija pedagoškog istraživanja*, 1979, Zavod za udžbenike, Sarajevo
- [7] Malić – Mužić, *Pedagogija*, 1983, SOUR „Vjesnik“, Zagreb.

# The Right of Interactive Communication of the Work to the Internet

N. Ljubojev, M. Z. Kavalić and S. Stanisavljev

University of Novi Sad, Technical Faculty "Mihajlo Pupin", Zrenjanin, Serbia.

nadezda.ljubojev@gmail.com, milazakin@gmail.com; sanja84stanisavljev@gmail.com

**Abstract – Today, due to technical improvement, individuals can make their own choice when it comes to the content they want to use over their technical devices anywhere and anytime they choose. By means of *interactivemedia*, individual that uses a computer connected to the Internet has the possibility to access various contents stored in other computers. Interactivity, as a new option in the process of public communication of the work and other contents by the means of information and digital technologies, is formulated as a separate economic right of the author. It is regulated by the Law on Copyright and Related Rights that author has exclusive right to allow any public communication of work by wire or wireless means including such communication to the public set that anyone can have access from a place and at a time they individually choose.**

## I. INTRODUCTION

Term "Information Technologies" refers to technologies that provide access to information over telecommunications. This includes the Internet and other information and communication media.

Modern information and communication technologies have created a "global village"[1] in which people can communicate with others across the world as if they were living next door. For this reason, information and communication technologies are often studied in the context of how modern communication technologies affect society. Author Elisabeth Georgiadou thinks that "the Internet is the 'global village' that McLuhan argued about"[2].

"Direct image sequence at a distance reveals a space of a rich and surprising pleasure that our civilization seeks as the most precious value" [3]. "And the world has become recognizable by the closeness converting into simultaneous drama surviving regardless of a place in the planetary space where the event takes place" [4]. "To be new belongs to a world that has become a picture" [5].

However, over the last decades, digital technology development caused a development of public communication systems by using images, sound and text where a receiver turns into an active subject that chooses the content which he or she would like to use

by the means of technical devices. This is the way how a communication system by interactive media functions.

The authors can use their work in different ways depending on its type. The work could be used by publishing, processing, reproducing, recording etc. depending on its character. These are just some of the aspects of exploiting the work of authorship. Presence and development of new technical forms of exploitation have broadened the notion and content of using the work of authorship. The Internet usage has also contributed to this fact and its emergence was a turning point not only in economic but also in social lives of all countries. The Internet is a global computer network daily accessed by millions of users worldwide.

## II. THE CONTENT OF SUBJECTIVE COPYRIGHT

The content of copyright includes a large number of rights that differ in their legal characteristics [6]. In the Law on Copyright all the original copyrights can be divided according to these two bases:

- Exclusive (absolute) and non-exclusive (relative) legal rights.
- Personal (moral) and economic legal rights.[7][8][9].

The largest number of personal and economic legal rights is absolutely exclusive, which is in the fact the core of subjective Law on Copyright. Those rights are indicated as subjective copyrights in a narrow sense. Hereinafter, only economic rights shall be analyzed.

There is also a smaller number of personal and economic rights that are non-exclusive, relative in nature, and are also selected in the subjective copyright content so that certain corrections and greater protection of authorship could be carried out. These rights are considered as subjective copyrights in a broader sense. In the Law on Copyright and Related Rights (Official Gazette of the Republic of Serbia, No. 104/2009, 99/2011 i 119/2012)) (hereinafter:

the Law) these rights are referred *as the author's rights towards the holder of the copy of the work*[10].

#### *A) Author's Economic Rights*

Exclusive economic rights protect economic interests of the author's work as an economic good. The countries of the Anglo-Saxon legal system give priority precisely to this component of the copyright legislation, which is also the prevailing attitude of the Universal Copyright Convention(Geneva).

These rights are constituted of the author's right to use the work of authorship and to dispose it. From the standpoint of copyrights, economic exploitation is present whenever a certain person communicates the work to the public regardless of whether in a particular place such an operation brings economic benefits or it is taken for non-profit purposes[7].

The content of the author's economic rights makes one particular utilization of the work. The usage of work is determined by the existing technical and economic opportunities for communication of the work to the public. By defining the content of the author's economic rights, the Law primarily in a form of general provision prescribes that the author has economic right on the work, as well as from any adaptation of the original work but also specifies the author's specific economic rights.

Through economic rights, the author gains economic values of the work and the exclusive right to decide permit or prohibit other holders to exploit the work and to determine the way it can be used.

The economic rights are mostly exclusive (absolute), transmittable, inheritable, time-limited and subject to restrictions [11][12].

The original holder of the economic rights is the author of the work. However, the author does not always undertake all the actions related to the work exploiting by him or herself. Therefore, copyright usage is mostly performed by specialized entities for particular activities (publishing companies, broadcasting companies, video game companies etc.).

The author's economic rights may be related to any exploitation of the work in any shape (physical or non-physical). If there is a need for the work *sample* (regardless of whether it is an original or non-original copy) the work exploitation is considered to be physical.

### III. THE RIGHTS OF EXPLOITING A WORK OF AUTHORSHIP IN A NON-PHYSICAL SHAPE

If for work exploitation a sample is not necessary it is considered to be a non-physical exploitation. However, it is noted that recently this division became relative "given that the new technical forms of reproduction and communication of the work (for example, the communication over the Internet) which in the International and Comparative Copyright Law have led to the extension of the notion of "the work reproduction", so it now includes both physical and (apparently) non-physical work reproduction in computer storage"[7][8].

#### *A. The Right of Interactive Communication of the Work to the Public*

The author has an exclusive right to prohibit or allow public communication of the work, including making it available to public by wire or wireless means in a way which allows an individual to access the work from a place and at a time that person chooses.

In theory, the relevant division of broadcasting according to technical means of distance signal transmission is considered to be: *wireless* broadcasting (radio diffusion) and *wired* broadcasting (cable diffusion) [7][13]. Thus, contemporary technical achievements offer different possibilities for broadcasting of the work and it inevitably requires an adequate legal regulation of the author's rights to the broadcasting [14].

Depending on whether the economic rights are *erga omnes* or *inter parts*, a distinction is made between the economic rights of exclusive and non-exclusive (relative) deeds. The author's right to interactive communication of the work to the public is exclusive, acting *erga omnes*.

This right is of a recent date. Mentioned form of exploitation of the work of authorship had not been covered by legal provisions (primarily right to broadcast) until 1996, when the Copyright Act World Intellectual Property Organizations (WIPO), that regulated this issue was adopted.

Apart from Berne Convention [15] provisions, Article 8 of the Copyright Law (WIPO), indicates that the author shall have the exclusive right to give permission or prohibit communication of his or her work to the public by wire or wireless means including the making available in such a way that member of the public may individually access the work from a place and at a time he or she chooses. This is indicated by the Law on Copyright and Related Rights from 2004 (Official Gazette of the Republic of Serbia No. 61/2004) [16].



The development of digital broadcasting technologies caused greater usage of radio and television. The audience has the possibility to individually choose programs (*television, radio - on-demand*) and the Internet as a world computer network [17].

In theory, it is emphasized that "classical" broadcasting involves a "one-way transmission of a signal from a broadcasting station to a recipient" [7]. The development of information and communication technologies has enabled the development of public communication systems by using images, sound and text where receivers turn into active subjects that choose the content on their own by the means of technical devices. That is the reason why communication systems called interactive media are being used more often.

For example, someone whose personal computer is connected to the Internet can have an individual access to different contents of his or her own choice that are stored on other computers worldwide.

However, interactivity, as a new option in the process of public communication of the work and other contents by the means of information and digital technologies, imposed the question of whether such a form of public communication is covered by a copyright or not [7][8][18].

Considering the growing importance of this kind of exploitation of the work, in the International and Comparative Copyright Law and the Serbian Law, it has been formulated as a right to public communication of the work by wire or wireless means that includes the author's right to "classical" and "interactive" broadcasting of the work.

Theoretically speaking, some of the authors consider that there is a basis for interactive communication of work to the public to be a way of broadcasting but because of the importance of this communication form (primarily because of the Internet) nowadays it has to be treated as a separate economic right [7][8][19].

According to this, the content of this right is the communication of the work to the public by wire or wireless means including the making available in such a way that member of the public may individually access the work from a place and at a time he or she chooses.

Thus, the author *has the right* to give permission or prohibit that his or her work gets to be accessible to the public over the Internet.

American blogger Perez Hilton was sued in the United States for copyright infringement. He was sued by Robert Caplin, *New York Times* photographer, for publishing photographs from his website without permission.

Perez Hilton is being whacked with a \$2.1 million lawsuit by Robert Caplin for publishing 14 photographs without permission. According to court documents, Caplin claims Hilton (whose real name is Mario Lavandeira Jr.) used 14 copyrighted photographs of Glee actor Darren Criss without asking after Caplin published 32 of the photographs to an online gallery (the photographs were originally published in a *New York Times* story about Criss' Broadway debut). The photographer is suing the blogger for copyright infringement and violating the *Digital Millennium Copyright Act* (DMCA) in refusing to take down the content. Caplin wants \$150,000 for each infringement, for a total of \$2.1 million [20].

Nowadays, thanks to these media, not only that a person that owns a computer connected to the Internet can have an individual access to a variety of contents by choice stored on other computers worldwide, but also if a person is connected to a cable television or radio network can individually choose contents that he or she wants to hear or see thus forming his or her own television or radio program.

Author's right to interactively communicate the work to the public includes two types of communication processes on the Internet:

- The first is the public communication of the work over e-mail
- The second one refers to uploading the work of authorship to the server where it becomes accessible to anyone from anywhere at anytime.

For instance, if we want to make one musical piece accessible to the public over the Internet, technically there are two ways how it can be done:

- 1) The first way is to upload the piece to some remote server - where it shall be available to the visitors of a particular website

This way is already covered by *copyright*.

The author has the right to give someone permission or prohibit reproduction of his or her own work. Reproduction presents any record of the work on tangible carrier which can directly or indirectly make the work available to the human senses [7][8][21]. Today, the duration of the record is not important which is particularly evident in the context of digital recording technologies and communication of the work to the public [22]. Thus, every person whose computer (even automatically) has registered a transient or short-term recording of the work of authorship has performed reproduction. However, the record can be found not only in the computer of the

person who actively communicates over the Internet, but it can also automatically be recorded on the remote computers which are necessary part of this computer network (servers).

2) The second way is to connect our computer and other computer networks worldwide over the Internet using special software (including that music piece) and make it accessible for viewing and downloading for others on the network.

This way is covered by *the author's right to communicate the work to the public by wire or wireless means including the making available in such a way that member of the public may individually access the work from a place and at a time he or she chooses.*

#### IV. CONCLUSION

The development of information and communication technologies has enabled the development of public communication systems by using images, sound and text where receivers turn into active subjects that choose the content on their own by the means of technical devices.

Interactivity, as a new option in the process of public communication of the work and other contents by the means of information and digital technologies, in the International and Comparative Copyright Law and the Serbian Law, is formulated as a separate economic right of the author.

The content of this right is the communication of the work to the public by wire or wireless means including the making available in such a way that member of the public may individually access the work from a place and at a time he or she chooses.

Thus, the author *has the right* to give permission or prohibit that his or her work gets to be accessible to the public over the Internet.

#### REFERENCES

- [1] Marshall McLuhan, *Understanding Media*, 1964.
- [2] E. Georgiadou, Marshall McLuhan's 'global village' and the Internet, Master Thesis (Master of Arts in Image Studies), University of Kent at Canterbury, Faculty of Humanities, 1995. Available from:  
[https://www.researchgate.net/publication/274383916\\_Marshall\\_McLuhan%27s\\_%27global\\_village%27\\_and\\_the\\_Internet](https://www.researchgate.net/publication/274383916_Marshall_McLuhan%27s_%27global_village%27_and_the_Internet) [accessed Aug 20 2018].
- [3] E. Umberto, *La struttura assente, Introduzione alla recera semiologica*, Milano.1968.
- [4] P. Ljubojev, "Televizijska kultura", Novi Sad, unpublished.
- [5] M. Heidegger, Holzwege, Vittorio Klostermann, Frankfurt am Main, 1963.
- [6] L., Bentley and B., Sherman, "Intellectual Property Law", Oxford 2004.
- [7] S. Marković and D. Popović, „Pravo intelektualne svojine“, Pravni fakultet Univerziteta u Beogradu, Beograd, 2013.
- [8] Z. Miladinović, "Pravo intelektualne svojine", Kragujevac., 2009.
- [9] D. Bainbridge, "Intellectual Property", Harlow, 2007.
- [10] Law on Copyright and Related Rights (Official Gazette of the Republic of Serbia, No. 104/2009, 99/2011 i 119/2012).
- [11] P. Goldstein and B. Hugenholtz, "International Copyright", Oxford University Press, 2010.
- [12] Ploman W., Hamilton E., Clark, L., Copyright: "Intellectual Property in the Information Age", London 1980.
- [13] M., Miletić, „Autorskopравни i susednopravni problemi u sistemu satelitskog emitovanja“, Pravni život, 11/1995.
- [14] V. Vuković, "Kvalifikacija emitovanja", Pravni život, 11/1998.
- [15] Berne Convention on the Protection of Literary and Artistic Works. Available from:  
[http://www.zis.gov.rs/upload/documents/pdf\\_sr/pdf\\_ap/bern.pdf](http://www.zis.gov.rs/upload/documents/pdf_sr/pdf_ap/bern.pdf). [accessed Aug 20 2018].
- [16] Law on Copyright and Related Rights from 2004 (Official Gazette of the Republic of Serbia No. 61/2004).
- [17] V. Besarović, „Intelektualna svojina“, Beograd, 2011.
- [18] M. Walter and S. von Lewinski, "European Copyright Law: A Commentary", Oxford University Press, 2010.
- [19] Terence Prime, "European Intellectual Property Law", Ashgate, New York, 2000.
- [20] Available from:  
<https://petapixel.com/2013/06/29/nytimes-photographer-sues-perez-hilton-for-2-1-million-for-copyright-infringement/>. [accessed Aug 20 2018].
- [21] N. Ljubojev and S. Varga, "Zaštita kompjuterskog program sa osnovama Autorskog i Patentnog prava", Univerzitet u Novom Sadu, Tehnički fakultet „Mihajlo Pupin“, Zrenjanin, 2014.
- [22] J. E. Cohen, L. P. Loren, "Copyright in a Global Information Economy", Aspen Publishers, 2010.

# Internet Usage by Children Under the Teen Age

A. Stojkov, D. Radosav and S. Mihajlović

Technical Faculty "Mihajlo Pupin", Zrenjanin, Republic of Serbia  
sahskica.s@gmail.com, dolores023@mts.rs, mihajlovcisinisa25@gmail.com

**Abstract** – In this paper will be discuss about Internet and Internet Usage in children, because they are increasingly using them. There also will be shown whether the children have replaced their friends with virtual friends or how the internet infect the physical activity, do they spend enough time outdoors, how often and for how long they use the internet and for what purposes. The research was conducted in two primary schools in Novi Becej, Republic of Serbia. Students range is in age from 8 to 14 years.

## I. INTRODUCTION

Internet is the biggest global network witch grown every day. No owner of the internet and because of that all people can use it for any purpose. At the beginning internet was used just for send messages. Today we have a lot of websites with different contents and everyone can find something interesting for himself. The internet can be used for communication, education, learning, fun, business, information... [1]

Today is the biggest concern for children's safety on internet because they can use internet without any control and can access to every content without special permission approved. They usually uses internet for playing games, listening music and for chatting with their friends. If followed by age there are differences in for what children use the internet the most. Older children use to communicate with other people. It is hard to agree whether the internet is good or bad for children. They can learn on the internet but, they can got a lot trouble too.

According to a sociologist Ellis Cashmore, if you forbid internet usage, that can be considered like child abuse. He surveyed 2,000 Internet users to gather information about how they use technology, and found that caring for the risk to children which were exposed was excessive. He also believes that the Internet is offered to children a full range of activities similar to what they would do when offline, and that banning the use of the Internet can have a negative impact on social development. "... Imagine if parents forbade their children to read, watch or talk to other children, to play some educational games, to draw, to paint, to dance.

Kids do all these things on screens too ... ". "... Screens are part of their reality. If you deprive them of their ability to mature, that's abuse." He also emphasize that it is important for children to grow up in a technology-dominated world today, so preventing children from using it would be very unusual. [2]

## II. LITERATURE REVIEW

UNICEF survey was conducted in 2016 with the focus on potential risks and Internet usage of children. It has been found that children aged 8-17 were surrounded by smartphones, i.e. mobile devices that support internet access, within their households. It is revealed that with the increase in the number of households, the number of devices is increasing, so it is assumed that at least one such phone is owned by the youngest family members. In addition to mobile Internet access, it is proven that over 90% of households provide classic internet access, also served by children. The population of children between the ages of 8 and 17 is in a modern, technological environment where their internet access devices are at their fingertips. It was concluded that almost 95% of households in Serbia where children live and stay at this age have some of the internet connection. Moreover, it further emphasizes the potential exposure of this generation of Internet users to various forms of risk and danger [3].

The Ministry of Culture and Information addressed this topic in 2015, and at that time they came to the conclusion that the age limit at which children begin to use computers is decreasing year by year, with an increasing number of children already having access to a computer in their pre-school years whom they spend more than 2-3 hours a day. They argue that children are more computer literate than their parents and educators, and that, therefore, measures should be introduced to protect and prohibit access to certain sites. A lot of kids don't know how to read and write, but they know the name of their favorite characters, Tom and Jerry, and they can use a Google search engine. Children copy and imitate

what they encounter in their everyday environment. These can be parents or older siblings. In addition, they interact with peers, exchange experiences, and thus socialize. Therefore, it is necessary for the parent to interact with the children and prepare them for using the Internet, as a social network. [4]

For children living in remote places or for those excluded due to poverty, digital technology and innovation can open the door to a better future by offering them greater access to learning, communities of interest, service markets and other benefits that can help them achieve their potentials and break the chain of failure. Internet technologies have facilitated the interconnection of children and the sharing of experiences online, but also the use of these new channels of connectivity and communication have increased the chances of online violence, with a much greater reach and thus a potentially greater risk of offline violence. It also increased opportunities for widespread abuse and exploitation of children's privacy and changed the way children view their personal information. [5]

#### A. *The good sides of the internet*

If a child is suffering from a serious illness and the Internet helps him or her make new friends and have fun. For example, "For a boy living with cerebral palsy who interacts with his peers on the Internet, his abilities become more visible for the first time in their lives than his inability" then the internet does well. It can also be used for education. If a child is unable to go to school because of difficult conditions, this is an ideal path to adopt new knowledge and then apply that knowledge to create the future, as a girl who has escaped violence with her family in the Syrian Arab Republic and she is learning from her teacher using a tablet to take the future into his own hands at the Zaatari refugee camp. Also, if it is for advertising or for help, it may be helpful. "A young blogger in the Democratic Republic of the Congo is using the internet to spread news about the lack of drinking water and sanitation, as well as other serious problems in his community." [5]

#### B. *The bad sides of the internet*

There are many downsides to the internet, some of them are when the law deprives a child of the possibility of using the internet as a girl who, according to the rules of her family or society, is forbidden from using the internet and misses the opportunity to learn and connect with friends. Or when children do not understand the seriousness of the internet and post their personal information that is misused later, such as traffickers misusing

teenager's personal information by sharing it online. The downside is also when you create a kind of lullaby like a boy whose video game addiction took over, at least according to his parents. In addition to these, there are worse sides to the internet. Abuse is very difficult to avoid and which, when they happen to a child, are followed everywhere. [5]

### III. RESEARCH METHODOLOGY

The survey was conducted in January 2018 in the primary schools "Josif Marinkovic" (JM) and "Miloje Ciplic" (MC) located in Novi Becej. A total of 269 second- to eighth-grade students participated. In this research questionnaire was used. The subject of the research is the relationship of using the Internet, socializing with peers and engaging in physical activity in primary school children.

This research needs to find out if and to what extent primary school children use the Internet, at what age is the highest percentage of children using it, it is also necessary to find out whether, despite using the Internet, they manage to engage in physical activity and socialize with their peers.

The questions in the survey were formulated in order to draw that conclusion. The answers provided in the survey are mostly yes / no, which the respondent rounds up based on his opinion.

### IV. RESEARCH RESULT

Inside the table 1 are displayed a number of children grouped by gender and the school they come from. Two schools participated and they are elementary schools "Miloje Čiplic" (MC) and "Josif Marinković" (JM). the table shows that the number of girls and boys who participated in the survey is equal, 133 boys and 136 girls were interviewed.

SCHOOL	GRADE	BOYS		GIRLS		NUMBER OF KIDS	
		MČ	JM	MČ	JM		
	II	10	7	9	12	38	
	III	8	9	10	10	37	
	IV	6	10	10	12	38	
	V	12	9	8	12	41	
	VI	11	12	12	5	40	
	VII	10	7	7	8	32	
	VIII	13	9	9	12	43	
	SUM		70	63	65	71	269
SUM (GENDER)		133		136			
SUM (SCHOOL)						135	134

Table 1. Grade and number of children

According to the processed results of this research, in which 269 elementary school students aged 9-14 participated, conclude on the basis of the question that the internet is used in 95%.

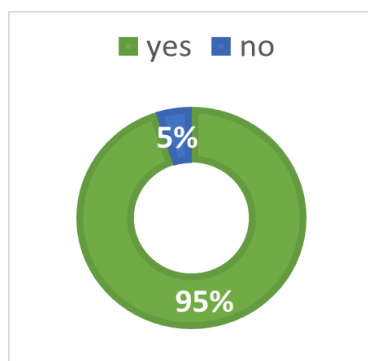

Figure 1. Answer on question: Do you use internet?

Children start using it very early from 6-7 years (21%), and there are extreme cases that started in their 2-3. but this percentage is very small. The internet is used every day (68%) or several times a week, which is less common and these are mostly younger children. Regarding the time period, children most often stay from half an hour to an hour (23%) or more than an hour (35%), the older they are, this time is prolonged and for some it reaches the whole day (14%). Internet usage is also prevalent at night (49%), where some children (31%) do not go to bed on time and then they are tired tomorrow, but this is a smaller percentage. Most go to sleep at the appointed time. As the Internet is widespread, children have access to and from their rooms, so they use it most often (74%). They use it for fun (76%), chatting (56%) and playing games (77%). Some even neglect school obligations (19%).

The answers to the questions asked about the physical activity of the respondents and staying outside under ordinal numbers prove that the majority (42%) of the respondents prefer to play on the street every day (56%) and stay between 1 and 4 hours (40%). Most also practice some sports (59%) several times a week (35%), where their training usually lasts about 60 minutes (47%).

	a. internet	b. sport	c. books	d. friends and family	e. TV	f. playing
	71	47	17	94	23	17
II	3	7	0	7	14	5
III	5	8	1	20	3	2
IV	4	8	6	17	1	2
V	10	8	3	17	2	2
VI	12	4	2	19	1	2
VII	13	6	2	8	1	2
VIII	24	6	3	6	1	2

Table 2. Answer on question: How do you spend your free time?

The answers to the questions asked about socializing with friends prove that almost all of them have friends (97%) with whom they socialize (97%) intensely, do not neglect them (96%) because of the Internet, but among students in higher classes compared to from the lower ones, may notice that interest in games relative to socializing with peers is growing. Most still hang out with friends (81%) more than play games online (19%), and spend more than an hour together (68%) There are also those who, when in the community, use the Internet over the phone.

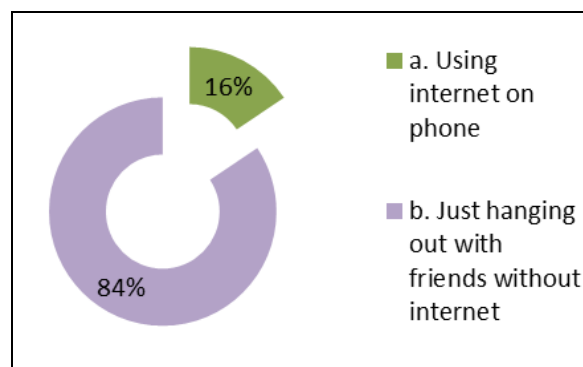

Figure 2. Answer on question: Do you use internet when you are with friends?

## V. CONCLUSION

These results show that children still prefer to spend time outside with their peers. They have enough physical activity and train some sport. Looking at the results, it could be seen that physical activity is decreasing and Internet usage is increasing, with increasing age in subjects. Also, answering the last question related to leisure, proves that physical activity and sports are decreasing and internet usage is increasing.

This research is very instructive and it can be observed that internet usage increases with increasing age of children. Further research can be extended to all ages of the population. Also, as the use of social networks is on the rise, research can show how they affect users, and whether they know that they can be the victim of abuse and whether they know how to protect themselves if they find in such a situation.

## REFERENCES

- [1] What is internet and internet usage. <https://racunarstvoinformatika.wordpress.com/2012/03/26/korisnjenje-interneta-kao-globalne-svetske-mreze/>

[2] Using internet in children, and the need to use it „Screen Society“, E.Cashmore, J. Cleland, K. Dixon, 2018.

[3] Unicef research on parents' awareness of the risks and abuse of children online <http://www.unicef.rs/files/Istrazivanje%20o%20nivou%20osvesti%20roditelja%20o%20rizicima%20od%20zloupotrebe%20dece%20na%20internetu.pdf>

[4] Good and bad sides of internet usage in children <http://www.glasopova.rs/?p=8736>

[5] Unicef research for good and bad sides of internet usage in children „Dete u digitalnom svetu“, Unicef, 2017

# Implementation of REST Web Services in Java Web Applications

N. Simić<sup>1</sup>, A. K. Zobenica<sup>2</sup>, B. Markoski<sup>1</sup>, V. Premčevski<sup>1</sup>

<sup>1</sup>University of Novi Sad, Technical Faculty "Mihajlo Pupin", Zrenjanin, Republic of Serbia

<sup>2</sup>University of Novi Sad, Faculty of Technical Sciences, Republic of Serbia

novak.simic21@gmail.com, kosticanja91@gmail.com, markoni@uns.ac.rs, velci.aspire@gmail.com

**Abstract** – Development of newest technologies puts web services in the foreground. Implementation of web services into web applications provides better way for distributed programming. Technologies behind Web can drive useful remote services, because those services exist and they are used every day. Every web application or web site is service. The features which make web site easy for a web surfer to use also make a web service API easy for a programmer to use. Widely used web services protocol are RESTful web services which gives web application better and faster performance on server. This is very important to clients who use web application, to get content from server very fast.

## I. INTRODUCTION

Web applications these days are developed using new and modern technologies, which provides better and better communication between client and server. That is the main thing that every programmer is striving for. New technologies bring new things to distributed programming. Constant innovation and development in web technologies brings newer web services. Web services are very important to programmers on one side and clients on another, because they communicate through protocol from server to client machine where it serves certain information to client and it accelerates process of developing web applications.

Server-side applications should provide users with common information in any time. Responsibility for that is usage of web services and its benefits. REST web services use particular methods to provide users with information from database. This way user can access, modify or delete information any time from database using these methods. The most reliable and secure way for serving information to user through out application is using of web services.

## II. WEB SERVICES

Web services represent client-server application of application component which provides communication. That is collection of standards and protocols for exchanging information between two devices or application. Web services can communicate with other applications through web services over the network, Java can interact with .Net, PHP applications. They are a language independent way of communication.

There is two types of web services:

- **SOAP** (Simple Object Access Protocol) web services
- **REST** (Representational State Transfer) web services

SOAP web services are designed with common XML-based protocol. Main thing is to allow for machine readable document to be passed over multiple connection protocol to create decentralized, distributed system. SOAP is stateless, one-way message exchange paradigm between SOAP nodes, from SOAP sender to SOAP receiver. The process of invoking web services is very important; therefore, the SOAP protocol is established to exchange messages between service providers and consumers. [1] SOAP is a lightweight protocol that is platform independent, transport independent, and operating system independent, because it is built using time testing systems like the HTTP protocol and text mark-up in XML.

REST web services are services that are build using HTTP, URIs, XML, JSON, Atom. Like SOUP web services RESTful web services relies on a stateless, client-server, cacheable communication technology that uses the HTTP protocol. REST is considered as architectural style for developing web application written in different programming languages. In REST, the web services are presented as resources and can be identified by their URLs. Clients' needs to use globally defined set of remote methods that represents certain action to be performed, if they want to use and access web services. HTTP protocol includes mechanisms to control caching.[15]

### III. REST WEB SERVICES

REST is an architectural style, which uses existing HTTP method and actions and does not create any new standards. It just means that a server has a resource and a client can request a "representation" (i.e. a description) of the resource's "state" (i.e. data). [2] SOAP web services may be a good choice, but a REST web services is better when you have to develop lightweight APIs with great performance and support of CRUD operations. REST is like a three-wheeler that rests on Resources, Representation, and Verbs. [3]

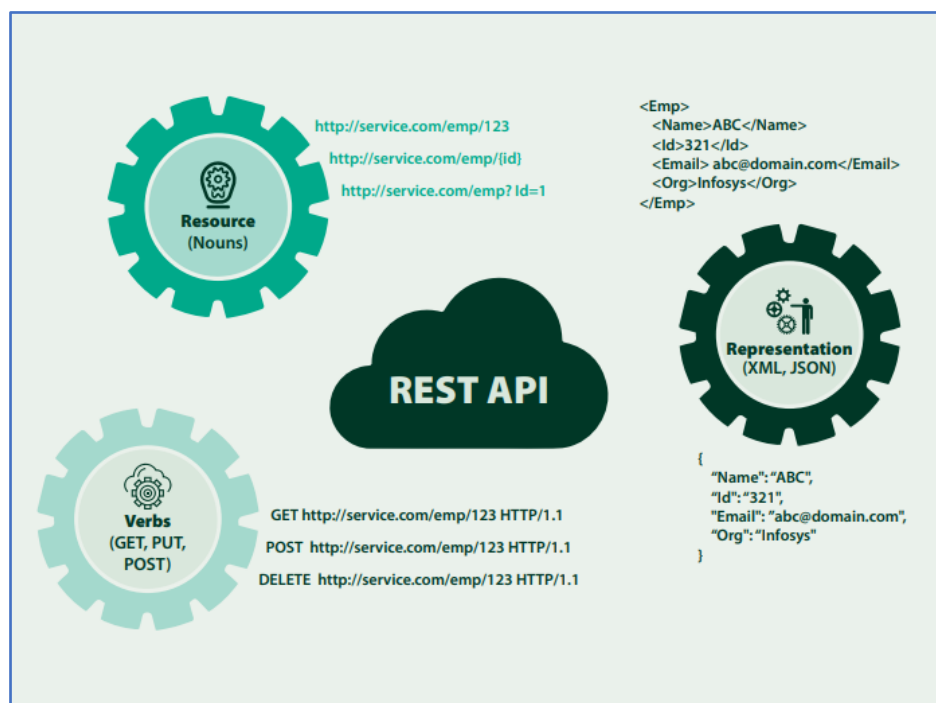

Figure 1: REST architectural style[16]

#### Resources

Resources represent the fundamental elements of the web platform. First thing is to identify the resources and find out how they are linked with each other while working with REST web services. Many RESTful Web services support at least two response formats (typically XML and JSON).[5] Every resource on web has its own identifier, which is known as universal resource identifier (URI) and the best example is uniform resource locator (URL). In REST web services, nouns are used to identify which type is resource.

Some resources only accept parameter values as URL-encoded form data in the request body. [6]

Most APIs (86%) in the set being analyzed require user authentication for API calls. [9] There is one example that shows it. Employee information that is stored in company database can be accessed using following URL:

**URL: <http://EmployeeService/Employee/1>**

#### Verb

Verb represent an HTTP action like POST, GET, PUT, DELETE, etc.



RESTful APIs enables developer to develop any kind of web applications having possible CRUD operations. REST architectural style suggests using a specific HTTP method on a specific type of call made to server. In some cases, the more uncommonly used HTTP verbs, such as PATCH, are not supported by existing tools and frameworks. [7]

**HTTP GET** method retrieves resource representation/information only - and it doesn't modify it in any way. GET request do not change the state of resource, it is the safest method to use. Also GET APIs should not be idempotent, which means that making multiply identical requests have to produce same result every time until another API (POST or PUT) has changed the state of the resource to server. A client's GET request message may contain headers but nobody. [4] Server will return HTTP response code 200 (OK), if HTTP GET APIs resource is found along with response body which usually is one of format like XML or JSON script language. If response is not found on the server than HTTP will return response code 404(NOT FOUND) or 400(BAD REQUEST).

**HTTP GET API** request **URI** is shown below:

- HTTP  
GET <http://www.appdomain.com/users>
- HTTP GET  
<http://www.appdomain.com/users?size=20&page=5>
- HTTP GET  
<http://www.appdomain.com/users/123>
- HTTP GET  
<http://www.appdomain.com/users/123/address>

**HTTP POST** method creates new subordinate resources, for e.g. file is subordinate to a directory containing it or row is subordinate to a database table. POST methods are used to create new resource in collection of resources. If a resource has been created on the origin server, the server will return HTTP code response 201(Created) and contain an entity which describe the status of the request that has been sent to a server and it refers to a new resource, and a Location header. HTTP

calls the POST request method unsafe and non-idempotent, which means that its outcome is unpredictable and not guaranteed to be repeatable without potentially undesirable side effects. [4] In that case HTTP response code will be either 200(OK) or 204(NO CONTENT) as it is appropriate response status. POST method is neither safe nor idempotent and invoking two identical POST request will result in two different resource containing the same information (except resource id).

**HTTP POST API** request **URIs** are shown below:

- HTTP POST  
<http://www.appdomain.com/users>
- HTTP POST  
<http://www.appdomain.com/users/123/accounts>

**HTTP PUT** method primarily update existing resource (if the resource does not exist the API may decide to create or not a new resource). If there is a new resource created by the PUT API, the origin server must inform the user agent via the HTTP response code 201(Created) and if existing resource is modified, then there is either HTTP response code 200(OK) or 204(NO CONTENT) to indicate successful completion of the request. The difference between the POST and PUT APIs can be in request URIs. POST requests are made on resource collections, while PUT requests are made on an individual resource. It's also important that your usage of PUT remains consistent across all resources. [8]

**HTTP PUT API** request **URIs** are shown below:

- HTTP PUT  
<http://www.appdomain.com/users/123>
- HTTP PUT  
<http://www.appdomain.com/users/123/accounts/456>

HTTP DELETE method deletes new resource (identified by the Request - URI). Successful response of DELETE requests is HTTP response code 201(OK), if the response includes an entity describing the status, 202(ACCEPTED) if the action has been queued, or 204(NO CONTENT) if the action has been performed but the response does not include entity. DELETE method is

idempotent. Spring REST Depending on the service implementation, the resource may or may not be physically deleted. [6] Repeatedly calling DELETE API on the resource will not change state of resource - however calling DELETE on a resource a second time will return HTTP response code 404(NOT FOUND) since it was already removed.

**HTTP DELETE API request URIs** is shown below:

- HTTP DELETE  
<http://www.appdomain.com/users/123>
- HTTP DELETE  
<http://www.appdomain.com/users/123/accounts/456>

#### IV. RELATED WORK

##### A. *Example of java-based restful web service*

Development of RESTful web services in Java web applications contributed better performance and faster response on client/server architecture. Implementation of REST web service in Java web application is designed to provide clients with necessary information about employees and provide better security of information.

The authors in [10] analyzed the 45 most popular web APIs that uses *programmableweb.com* repository for a number of mashups to show as sorting metrics and 17 features. Result represent diversity REST principles or in design decisions, where are missing standards regarding to REST. It is necessary to up-to date look on current state of web APIs after these results.

Modeling REST client-server conversations with language that correspondent with it is presented in [11] reference. Authors refers that most APIs are simply exposing low-level HTTP details without hypermedia controls.

Authors in [12] analyze the degree of compliance with the REST architectural principles, form perspective of mobile applications. There are collected 78GB of data logs of HTTP requests from a large mobile operator to identify the pattern and matched 26 best practices for web services.

In [13], the authors analyze in this work interfaces of client-server technologies which includes web APIs used for web services and point out the reason for the misuse of REST principles. Also, authors discuss that some mechanisms are much more successful at web API reuse and useless of interface description for REST web APIs.

Semantically analyzing the URIs of web services authors in [14] analyze 18 popular web services. Result includes detection of syntactical URI design issues. That means API designers tend to use adequate resource names and no verb in URIs.

In this paper, we designed study with broad objective of understanding the state of the practice of REST web services. We provide additional information that may support previous work. Development of newer technologies in web environment, such work is outdated, leaving practitioners and researchers with a bit of information for designing and developing services, or pursuing on this topic.

##### B. *Example of the web application*

This web application is developed using Spring Boot, Maven, Hibernate, MySQL, Tomcat local server and JPA. These are latest technologies that provide more securable and faster way of developing today's web applications and web services. REST web service that was implemented in this application uses CRUD (Create, Read, Update, and Delete) operation to manage information in database and present it to users. For developing web application MVC (Model, View, Controller) pattern is used for better organization of code and easier access to objects.

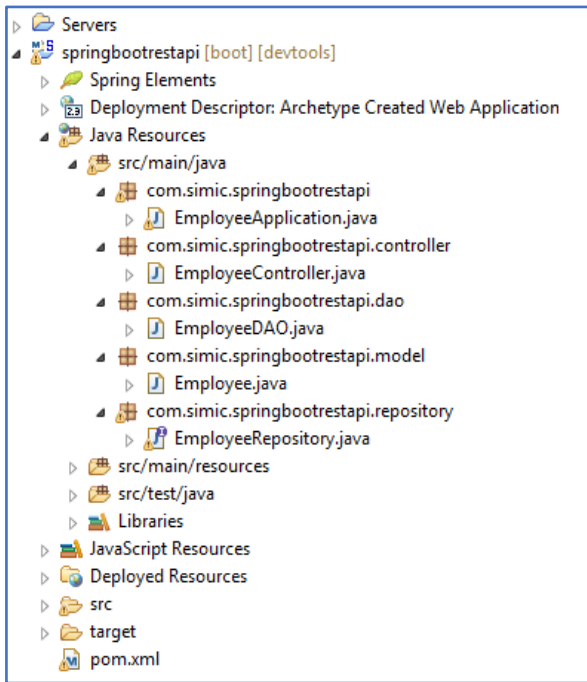

Figure 2.Spring Boot REST API

Implementation of CRUD operations that handle the data in database and represent it to a server is presented using MySQL controller and JPA repository which connect MySQL database to web application. Testing REST APIs requests and responses to local server is simulated using Postman software.

#### GETlocalhost:8080/company/employees/

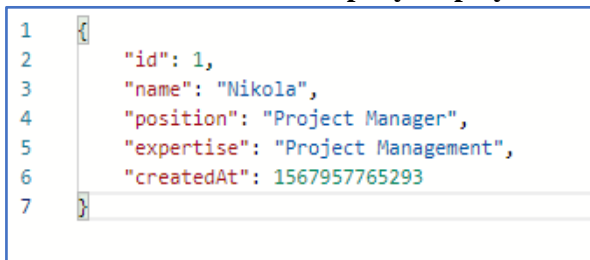

Figure 3.GET request REST API

#### POSTlocalhost:8080/company/employees/



Figure 4.POST request REST API

#### PUTlocalhost:8080/company/employees/5

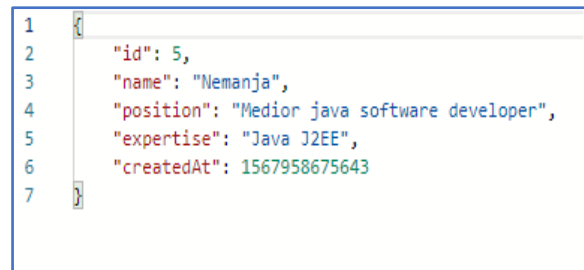

Figure 3.PUT request REST API

#### DELETElocalhost:8080/company/employees/5

Delete method deletes employee with id (5) and returns response status 200(ok) or Boolean true value. When all of these requests pass the testing phase than REST web services are ready for production process and web application is created.

## V. CONCLUSION

REST web services improve performance of web application and are very important in communication with clients. It represents state of an object on server, and it will serve clients with information. Constant improvements in new technologies provide better improvements of web services and provide greater performance and opportunities to web applications. Very important thing is to maintain security of information on server and communication to clients. Providing faster response to client creates better web application what is very important to developers.

### Acknowledgements

This work was partially supported by the Ministry of Education, Sciences and Technological Development of the Republic Serbia (Grant no. ON-171039).

### REFERENCES

- [1] F. Halili, E. Ramadani, *Web Services: A Comparison of Soap and Rest Services*, Canadian Center of Science and Education, 2018.
- [2] K. Lange, *The Little Book on Rest Services*. A Dev Psychology. 2016
- [3] D. Kumar, *Best Practices for Building Web Services*, Infosys Limited, 2018.
- [4] M. Masse, *Rest API Design Rulebook*, O'Reilly Media, 2012.
- [5] P. Adamczyk, P. H. Smith, R. E. Johnson, M. Hafiz, *REST and Web Services: In Theory and In Practice*, REST: From Research to Practice, 2011.
- [6] B. Varanasi, *Spring REST*, Apress, 2015
- [7] F. Bulthoff, M. Maleshkova, *RESTful or RESTless - Current State of Today's Top Web APIs*, CEUR Workshop Proceedings, 2014.
- [8] M. Stowe, *Undistributed REST: A Guide to Designing the Perfect API*, MuleSoft, 2015.
- [9] A. Neumann, N. Laranjeiro, J. Bernardino, *An Analysis of Public REST Web Service APIs*, IEEE Transactions on Services Computing, 2018.
- [10] A. Ivanchikj, C. Pautasso, and S. Schreier, "Visual modeling of RESTful conversations with RESTalk," *Softw. Syst. Model.*, pp. 1–21, May 2016.
- [11] F. Bulthoff and M. Maleshkova, "RESTful or RESTless – Current State of Today's Top Web APIs," in *The Semantic Web: ESWC 2014 Satellite Events*, 2014, pp. 64-74.
- [12] C. Rodríguez et al., "REST APIs: A Large-Scale Analysis of Compliance with Principles and Best Practices," in *Web Engineering* vol. 9671, A. Bozzon, P. Cudre-Maroux, and C. Pautasso, Eds. Cham: Springer International Publishing, 2016, pp. 21–39.
- [13] M. Seraj, "We Create, We Connect, We Respect, Therefore We Are: Intellectual, Social, and Cultural Value in Online Communities," *J. Interact. Mark.*, vol. 26, no. 4, pp. 209–222, Nov. 2012
- [14] F. Palma, J. Gonzales-Huerta, M. Founi, N. Moha, G. Tremblay, and Y.-G. Guéhéneuc, "Semantic Analysis of RESTful APIs for the Detection of Linguistic Patterns and Antipatterns," *Int. J. Coop. Inf. Syst.*, vol. 26, no. 02, p. 1742001, May 2017.
- [15] D. Forsberg, *RESTful Security*, Nokia Research Center, 2009.
- [16] Restful web services, available at: <https://www.infosys.com/digital/insights/Documents/restful-web-services.pdf>

# Offline Availability of Data

A. Jašić\*, V. Premčevski\*, A. K. Zobenica\*\*, B. Markoski\*

\* University of Novi Sad, Technical Faculty "Mihajlo Pupin", Zrenjanin, Serbia

\*\* University of Novi Sad, Faculty of Technical Sciences, Novi Sad, Serbia

aleksandar.jasic96@gmail.com, velibor.premcevski@tfzr.rs, kosticanja91@gmail.com, markonins@yahoo.com

**Abstract** - Internet connection can be an issue on the go, which is the reason why progressive web apps often have offline support for reliable performance. Even in perfect wireless environments, caching data or using other storage techniques can substantially improve the user experience. There is a lot of ideas around offline data storage for JSON files, images and general static data required to provide a meaningful experience offline.

**Keywords:** data, storage, client, database, offline

## I. PROGRESSIVE WEB APPS

Progressive web apps (PWAs) are web apps developed using a number of specific technologies and standard patterns to allow them to take advantage of both web and native app features.

Web apps are more discoverable — it's a lot easier to visit a website than install an application, and they can also be shared via a link. Native apps are better integrated with the operating system and therefore offer a more seamless experience for the users. Native apps can be installed and used offline, and users love tapping their home screen icons to easily access their favorite apps, rather than navigating to it using a browser.<sup>[3]</sup>

With PWAs we have the ability to create web apps that can enjoy these same advantages. They should be discoverable, installable, linkable, network independent, progressive, re-engageable, responsive, and safe.

It's not new idea, some of them appeared in the past with different approaches. Progressive Enhancement and responsive design already allow us to build mobile friendly websites. Even working with no network connection and installing apps was possible in the Firefox OS ecosystem a few years ago.

To understand deeper how a PWAs differ from conventional responsive websites, the best way is to look at some good examples of PWAs: Starbucks, Housing.com, Soundslice, 2048 Game, MakeMyTrip, Uber, Pinterest, Yummly.

## II. CLIENT-SIDE STORAGE

Client-side storage works on similar principles as the server-side. JavaScript APIs, that allows storing data on the user's machine and retrieve them when needed.<sup>[4]</sup>

There is a lot of various usages such as:

- Personalizing site preferences
- Persisting previous activity
- Saving data locally and improving site performances
- Saving web app generated documents for offline use

In many cases, server-side and client-side are used together. That way user would have to download data only first time, and every other time, they would be retrieved from the database instead.

### A. Cookies

The concept of client-side storage has been around for a long time. Since the early days of the web, sites have used cookies to store information to personalize user experience on websites. They're the earliest form of client-side storage commonly used on the web.<sup>[4]</sup>

HTTP cookies (web cookies, browser cookies) are pieces of data sent from server to user's browser. Often, they are used to tell if two requests came from the same browser, for example-keeping a user logged in.

Most often, cookies are used for purposes of:

- Session management

Shopping carts, logins, game scores

- Personalization

Themes, user preferences, other settings

- Tracking

Analyzing user behavior

Cookies were once used for general client-side storage. Cookies are sent with every request, so they can impact performance, especially for mobile apps. Their usage was legitimate way to store data on client side, since it was the only way to do it. Nowadays it is recommended to use modern storage APIs.

Name	Value	Domain	Path	Expires / Max-Age	Size	HTTP	Secure	SameSite
1P_JAR	2019-03-...	.google.com	/	2019-04-11T21:48...	19			
ANID	AHWqT...	.google.com	/	2021-01-15T19:40...	68	✓		
NID	178=esO...	.google.com	/	2019-09-07T22:50...	178	✓		
OGPC	1901120...	.google.com	/	2019-05-06T22:05...	15			
UULE	a+cm9s...	www.goo...	/	2019-03-13T21:48...	174			

Figure 1. Cookies in the browser Inspect

### B. Cache storage

The Cache interface provides a storage mechanism for request or response object pairs that are cached. Note that the Cache interface is exposed to windowed scopes as well as workers. It is not necessary to use it in conjunction with service workers, even though it is defined in the service worker spec.<sup>[5]</sup>

An origin can have multiple Cache objects. Items in Cache do not get updated or deleted unless it is especially requested. Programmer is responsible for implementing how scripts handles Cache updates, also how often to purge cache entries. Each browser has limitations on the amount of cache storage that can be used. The browser

does everything to manage disc space, but it could happen for cache storage to be deleted.

Modern browsers support Cache API. It is designed for storing HTTP responses to specific requests. Cache API is pretty useful for storing website assets offline, so the site can be used with no difference even without a network connection. It is usually used with the Service Worker API, although it doesn't have to be.<sup>[4]</sup>

Name	Value	Domain	Path	Expires / Max-Age	Size	HTTP	Secure	SameSite
1P_JAR	2019-03-...	.google.com	/	2019-04-11T21:48...	19			
ANID	AHWqT...	.google.com	/	2021-01-15T19:40...	68	✓		
NID	178=esO...	.google.com	/	2019-09-07T22:50...	178	✓		
OGPC	1901120...	.google.com	/	2019-05-06T22:05...	15			
UULE	a+cm9s...	www.goo...	/	2019-03-13T21:48...	174			

Figure 2. Cache storage in the browser Inspect

### C. Web Storage

Browsers that implement the Web Storage specification define two properties on the Window object: local storage and session storage. Both properties refer to a Storage object—a persistent associative array that maps

string keys to string values. Storage objects work much like regular JavaScript objects: simply set a property of the object to a string, and the browser will store that string.<sup>[8]</sup>

The Web Storage specification says that it is possible to store structured data, such as objects and arrays, as well as primitive values and built-in types (dates, regular expressions, File objects).

The difference between local storage and session storage involves the lifetime and scope of the storage. Data stored through local storage is permanent: it does not expire and remains stored on the user's computer until a web app deletes it or the user asks the browser to delete it.

Local storage is scoped to the document origin. The origin of a document is defined by its protocol, hostname, and port, so each of the following URLs has a different origin.

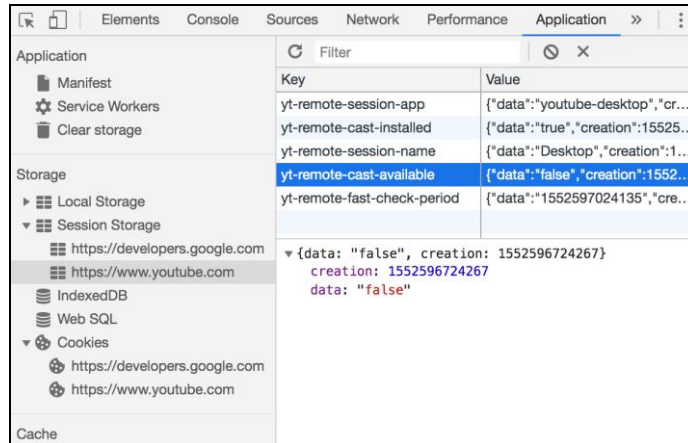

Figure 3. Session storage in the browser Inspect

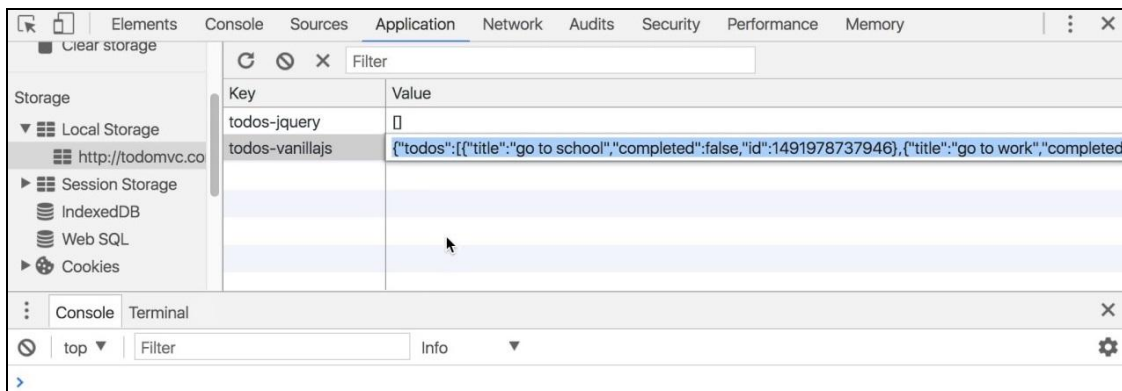

Figure 4. Local storage in the browser Inspect

LISTING I. CODE EXAMPLE USING WEB STORAGE

```
// Query a stored value.
var name = localStorage.username;
// Array notation equivalent
name = localStorage["username"]; if (!name) {
  // Ask the user a question.
  name = prompt("What is your name?");
  // Store the user's response.
  localStorage.username = name;
}
// Iterate through all stored name/value pairs
for(var name in localStorage) {
  var value = localStorage[name];
}
```

D. CLIENT-SIDE DATABASES

Between all of the HTML5 APIs, the most surprising are client-side databases. These are not just client-side APIs for accessing database servers across the network,

but actual databases stored on user's machine, directly accessed by scripts in the browser.<sup>[7]</sup>

In addition to Web Storage, there are multiple client-side database APIs that represent “real” databases. They can be divided in to major groups:

- Relational Databases - The real represent of this group is Web SQL Database, lightweight and simple relational database
- Object Databases - IndexedDB is true represent of this group, covered with a lot of different libraries such as PouchDB, ZangoDB, dixie.js, JsStore, and others.

#### A. Web SQL Database

Web SQL Database is a relational database that supports some of basic SQL queries. Browsers like Chrome, Safari, and Opera implemented this API, but Firefox and IE have not. Official specification of this API has stopped and this full-featured SQL database will probably never

become an official standard nor an unofficial but interoperable feature of the web platform.<sup>[7]</sup>

LISTING II. WEB SQL CREATE TEMPLATE

```
var db = openDatabase('webSQLdb', '1.0',
    'Test DB', 2 * 1024 * 1024);
db.transaction(function (tx) {
    tx.executeSql('CREATE TABLE IF NOT
    EXISTS LOGS (id unique, log)');
    tx.executeSql('INSERT INTO LOGS (id,
    log) VALUES (1, "foobar")');
    tx.executeSql('INSERT INTO LOGS (id,
    log) VALUES (2, "logmsg")');
});
```

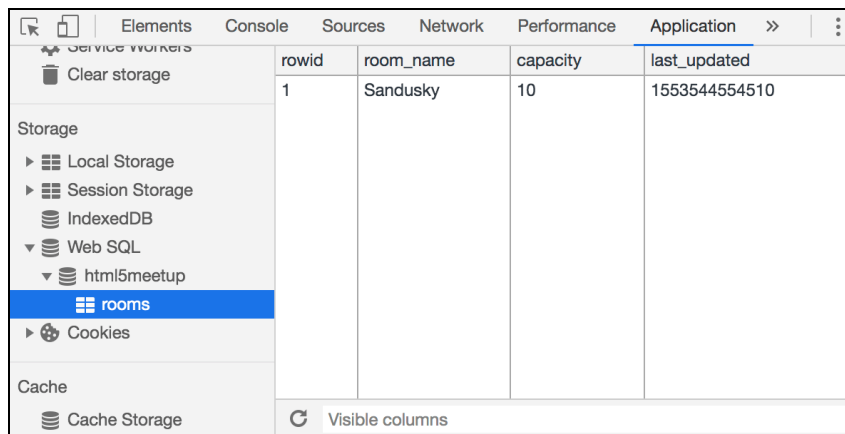

Figure 5. Web SQL database in the browser Inspect

#### B. IndexedDB

IndexedDB is an object database, and it is much simpler than databases that support SQL queries. It is more powerful, efficient, and robust than the key/value storage provided by the Web Storage API. Like the Web Storage and the Filesystem API, IndexedDB databases are scoped to the origin of the containing document: two web pages with the same origin can access each other's data, but web pages from different origins cannot.<sup>[7]</sup>

Each origin can have any number of IndexedDB databases. Each one has a name that must be unique within the origin. In the IndexedDB API, a database is simply a collection of named object stores. As the name implies, an object store stores objects. Each object must have a key by which it can be sorted and retrieved from the store. Keys must be unique—two objects in the same store may not have the same key—and they must have a natural ordering so that they can be sorted. JavaScript strings, numbers, and Date objects are valid keys. An IndexedDB database

can automatically generate a unique key for each object inserted into the database. Often, though, the objects that are inserted into an object store will already have a property that is suitable for use as a key. In this case it is possible to specify a “key path” for that property when the object store is created. Conceptually, a key path is a value that tells the database how to extract an object's key from the object.

In addition to retrieving objects from an object store by their primary key value, there is possibility to search based on the value of other properties in the object. In order to be able to do this, it is possible to define any number of indexes on the object store. Each index defines a secondary key for the stored objects. These indexes are not generally unique and multiple objects may match a single key value. So when querying an object store via an index, generally use a cursor, which defines an API for retrieving streaming query results one at a time. Cursors can also be used when querying an object



store for a range of keys, and the IndexedDB API includes an object for describing ranges of keys.

LISTING III. CODE EXAMPLE OF INDEXEDDB CREATE

```
(function() {
  //Check for support
  if (!('indexedDB' in window)) {
    console.log('This browser doesn\'t
    support IndexedDB');
    return;
  }
  //Create or open database
  var dbPromise = idb.open('test-db2',
  1, function(upgradeDb) {
    console.log('making a new object
    store');
    if
    (!upgradeDb.objectStoreNames.contains
    ('firstOS')) {
      //Create object store
      upgradeDb.createObjectStore('firstOS');
    }
  });
})();
```

LISTING IV. CREATE NEW INDEX TEMPALTE

```
var objectStore =
upgradeDb.createObjectStore('notes',
{autoIncrement: true});
//Create index
objectStore.createIndex('indexName',
'property', options);
```

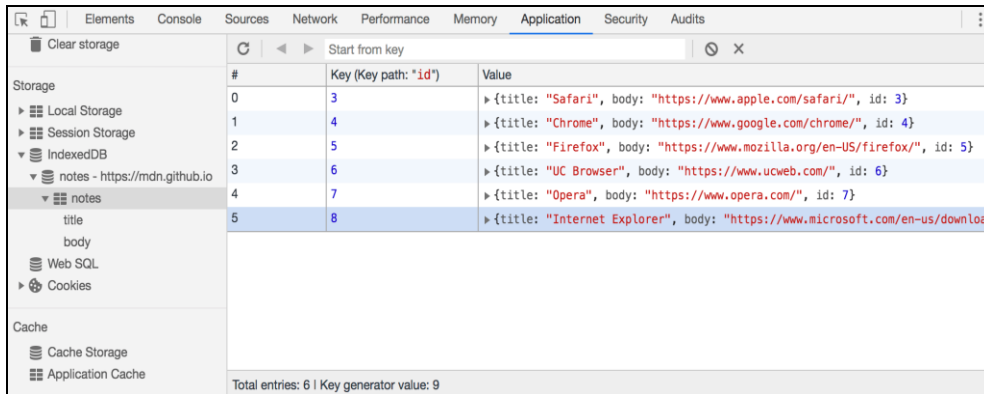

Figure 6. IndexedDB database in the browser Inspect

JsStore is made for developers who usually work with relational databases, so it makes IndexedDB easy to use with SQL like APIs.

LISTING V. JSSTORE CREATE INDEXEDDB DATABASE TEMPLATE

```
//Initiate jsstore connection
var connection = new JsStore.Instance();
//Create database schema
var tblProduct = {
  name: 'Product',
  columns: {
    Id: { primaryKey: true, autoIncrement:
    true },
    ItemName: { notNull: true, dataType:
    "string" },
    Price: { notNull: true, dataType:
    "number" },
    Quantity : { notNull: true, dataType:
    "number" }
  }
};
var tblOrder = {
```

```
  name: 'Order',
  columns: {
    OrderId: { primaryKey: true,
    autoIncrement: true }
  }
};
var db = {
  name: dbName,
  tables: [tblProduct, tblOrder]
}
var isDbCreated = await connection.initDb(db);
// isDbCreated will be true when database will
// be initiated for first time
// and false after that.
```

Using JsStore, every column that is initiated is equivalent to index when table is created in IndexedDB. It means that every initiated column can be searched, like in real relational database.

DI. CONCLUSION

There is a lot of different ways to store data on client-side. Some of them were pioneers, and some of them are new age technologies that are commonly used by developers. Main difference is that new technologies provide good performance, yet there is still lack of safety, which is main problem to all client-side storages. Some of them, like IndexedDB are supported and used by Google in PWA documentation, like an example of good practice. There is a lot of space for these technologies to make improvement in world of web and mobile apps.

REFERENCES

- [1] Raymond Camden, "Client-Side Data Storage.", United States of America, January 2016.
- [2] Kerri Shotts, "Mastering PhoneGap Mobile Applications Development", Birmingham B3 2PB, UK, February 2016.
- [3] [https://developer.mozilla.org/en-US/docs/Web/Progressive\\_web\\_apps/Introduction](https://developer.mozilla.org/en-US/docs/Web/Progressive_web_apps/Introduction)
- [4] [https://developer.mozilla.org/en-US/docs/Learn/JavaScript/Client-side\\_web\\_APIs/Client-side\\_storage](https://developer.mozilla.org/en-US/docs/Learn/JavaScript/Client-side_web_APIs/Client-side_storage)
- [5] <https://developer.mozilla.org/en-US/docs/Web/API/Cache>
- [6] <https://developers.google.com/web/ilt/pwa/working-with-indexeddb>
- [7] <https://learning.oreilly.com/library/view/javascript-the-definitive/9781449393854/ch22s08.html>
- [8] <https://learning.oreilly.com/library/view/javascript-the-definitive/9781449393854/ch20s01.html>
- [9] <https://jsstore.net/tutorial/get-started/>

# Interoperability of Distributed Business Web Applications

S. Mihajlović, Lj. Kazi and B. Radulović

University of Novi Sad, Technical Faculty "Mihajlo Pupin", Zrenjanin, Republic of Serbia  
mihajlovicsinisa25@gmail.com, ljubica.kazi@gmail.com, biljana.radulovic66@gmail.com

**Abstract** – This paper describes the concept of interoperability of distributed business web applications, as well as the division of application into layers, and the explanation of individual layers. This paper presents an example of the problems of data exchange between retail and wholesale. An example is implemented using software tools such as Microsoft SQL Server Management Studio, software development environment Microsoft Visual Studio 2017 and Notepad++.

## I. INTRODUCTION

The transition from standalone architectures to networked information systems architectures enabled the development of information and communication technologies. Networked IT systems rely on the infrastructure of the World Wide Web and is a technological scheme for e-commerce. It enables different business processes and connections of the statistical system. Statistical systems are a heterogeneous rapidly evolving environment. Interoperability refers to the ability of two system exchange information [1].

Interoperability is the ability of different information systems to work together [1]. Interoperability is the ability of a system or product to work with other systems or products without the special effort of the user [2].

Vernadat defines interoperability as the ability to communicate. Establishing interoperability means connecting two systems together and eliminating incompatibilities between [3].

Interoperability exists at 3 levels:

- Interoperability of business systems,
- Application interoperability, and
- Interoperability of data [4].

The interoperability layers are:

1. Technical layer. Message were exchanged securely and reliably from the sending system to the receiving system. The receiving infrastructure is responsible for delivering the data to the application on its side. Technical interoperability takes care of the technology, standards and politics used to connect computer systems.
2. Semantic layer. Application are aware of the business context to which the data belongs. The application can successfully process the data.

Semantic interoperability ignores all technical aspects and focuses on the content of the transferred information.

3. The organizational layer. The application notifies those users who are responsible for verifying and approving business steps, as well as monitoring deadlines. Organizational interoperability takes care of the operational and organizational structure of participating systems [5].

The code on the web server software is called a web application. In the business world, using web applications has become inevitable. Web applications are software solutions that are accessed through a web browser by users over a network such as internet or intranet. Web applications are an integral part of our lives. Web application are available anytime, anywhere, from any device. For example, email checks are done using the web application, as well as newspapers, social network, etc. Web applications do not need to be update periodically on the device they are accessing as they are accessed identically on each device via a web browser. The most important reason why web applications are heavily used is to update and maintain without distributing and installing software on client computers [6].

Distributed applications are created for applications that have many users, many business processes that need to be automated, and a large database. Distributed applications are application that require multiple physical separate computers, the data used by the application resides in multiple physical location [7].

Distributed applications can communicate with multiple servers or devices on the same network from any location. Distributed applications are divided into two separate programs: client software and server software. The client server or computer accesses data from the server or cloud environment, while the server or cloud processes data. Cloud computing can be used instead of servers or data processing hardware. If the component of a distributed application is canceled, it can be redirected to another component and continue with further work [8].

Business software or business application is any software or set of computer programs that users use to perform various business functions. This business applications are used to increase productivity, measure productivity, and perform other business functions accurately [9].

## II. RELATED WORK

Interoperability is a key issue in manufacturing and industrial enterprise. It is essential for production, services, quality maintenance and customization. Data sharing and IT applications are of great importance for the success of interoperability, communication between businesses [2]. The main drawback of enterprise collaboration is the problem of communication between people, between people and ICT systems, and between different ICT systems. The parties involved must exchange business information and have the same understanding of the meaning of the information exchanged, and for communication and content to be valid. Collaboration i.e. interoperability has multiple definitions. There are several layers of interoperability, and they are the data layer, the resource layer and the business process layer, and interoperability can be multiple levels [10].

Interoperability has proven to be a principle in the conception and implementation of the e-government initiative, and interoperability frameworks are a tool for applying the principles. The tools are interoperability frameworks and enterprise architecture [11]. An e-government interoperability framework is a document or group of documents that define a set of common elements such as dictionaries, concepts, principles, guidelines, recommendations, standards and practices for agencies that want to work together, joint delivery of public services. Government consider interoperability frameworks as promising instruments to increase the interoperability of their services and systems. Many countries have since made their own interoperability frameworks [12]. E-government continues to be recognized as a key strategy for improving government services and the effectiveness of public policies and programs. A key component of the e-government initiative is the ability of multiple government and non-governmental organizations to share and integrate information across their traditional organizational boundaries. E-government interoperability is the set of multidimensional, complementary and dynamic capabilities needed among these networks of organizations to achieve successful information sharing [13].

Interoperability between different systems in information sharing is very important, but other aspects are also needed. This process is based on the need for collaboration, sharing and mutual understanding of the needs of each participant. It follows principles that indicate the need for a formal semantic definition of the model to facilitate the work at different levels of abstraction from specification to implementation [14]. Integration is considered to go beyond measures of interoperability and involve some degree of functional dependency. Interoperable systems can function independently, integrated systems lose significant functionality if service flow is interrupted [15]. Enterprise interoperability is a well-established field of applied research that addresses the problems of systems deficiency and application interoperability in organizations and proposes new solutions to problems

[3]. To solve the problem of interoperability can be divided into three parts, the problems involved in the ontology, those related to architecture and platform and those related to the enterprise model. The first part allows for a common vocabulary, the second enables the interoperability of technical aspects, and the third provides supply chain models that enable the interoperability of practices at interfaces [16].

Amazon is an American e-commerce company. Amazon manages its online service centers, and records customer data behavior. Additionally, it has Twitter collaboration, and allows their users to connect to their Amazon site. Has credit card payment capability. In addition, it has built-in music and movie players, allowing Amazon to showcase its interoperability by collaborating with multiple applications [17].

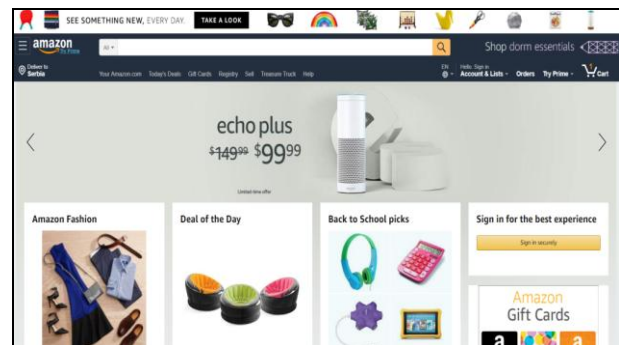

Figure 1. Amazon [17]

Office 365 is cloud-based subscription service. Office 365 brings together various tools that people use, some of which are Microsoft Office, Outlook, OneDrive, Skype, etc. It has wide application, and the ability to work on multiple devices, everything works online [18].

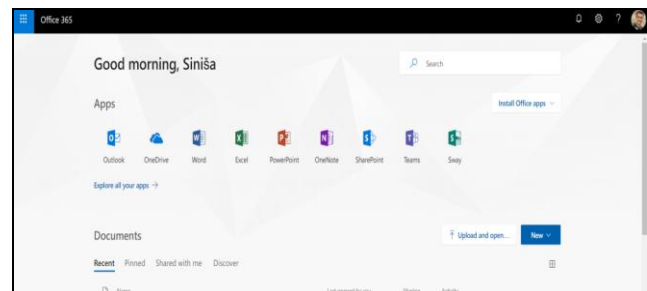

Figure 2. Office 365 [18]

Dropbox is a file hosting service and allows uploading of various files. The advantage is that the user can synchronize files online across all devices via Dropbox accounts [19].

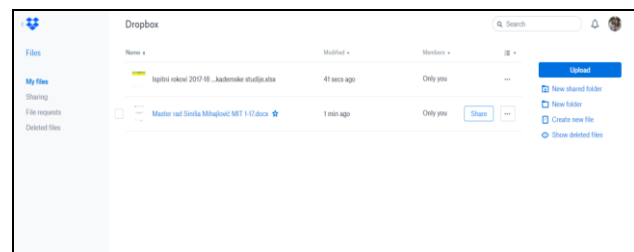

Figure 3. Dropbox [19]

### III. DEVELOPMENT MODEL

This section will show the component diagram, the deployment diagram, and the class diagram. The component diagram shows the organization and dependencies between the components. Figure 4 shows a component diagram showing the components of a web application.

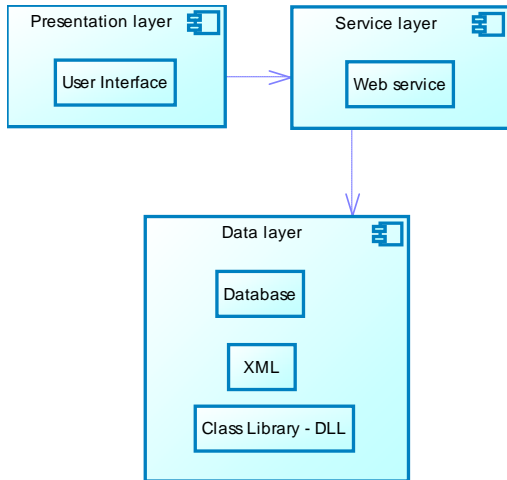

Figure 4. Component diagram

The deployment diagram represents the arrangement of software components by nodes in a computer network. Figure 5 shows deployment diagram showing the arrangement of components in a web application.

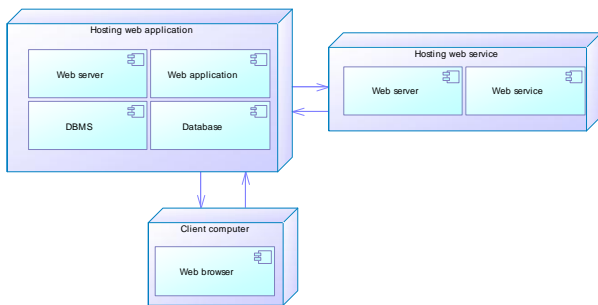

Figure 5. Deployment diagram

Class diagrams represent software solution classes and their dependencies. Figure 6 shows the classes of data layers created for this work.

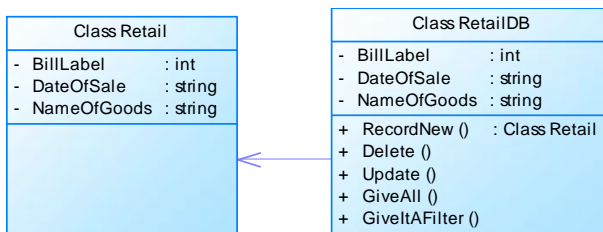

Figure 6. Class diagram

### IV. THE SOLUTION

An example of a business process that is chosen to illustrate implementation example is to enter bill information. When the user enters the bill information, they should enter the bill label, date of sale and name of

the goods. The name of the goods appears in the combo box control and is read from the XML document, which contains the goods code, the name of the goods and the price of the goods. Based on the name of the goods, the price of the goods in the new label is deduced from XML.

The goal is to show the usage of the web application by the user. Examples for the following software features are shown: data entry, data storage and data review. The technologies used to implement the examples are MS SQL Server, Visual Studio 2017, Notepad++ to create the XML document, and PowerDesigner to create the model. A part of the program related to entering bill information has been implemented. Bill items are entered into the database, via the user interface. The web interface is used by the user interface to be able to retrieve price data. Price information is read through the name of the goods in the XML document. In order to use the user interface and perform the entry and spreadsheet, a web service must be started first. Figure 7 shows the layout of the basic screen for entering bill information, and Figure 8 shows the layout of the basic screen for tabular display bill information.

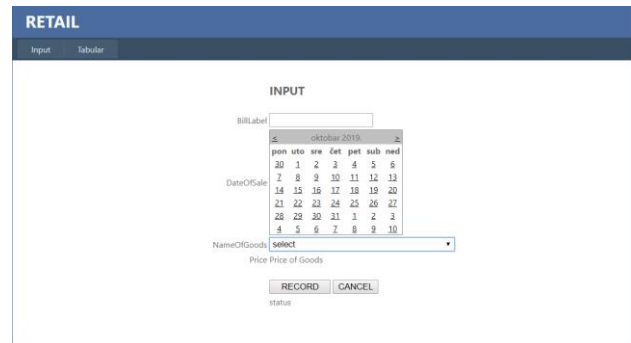

Figure 7. Layout of the basic screen for entering bill information

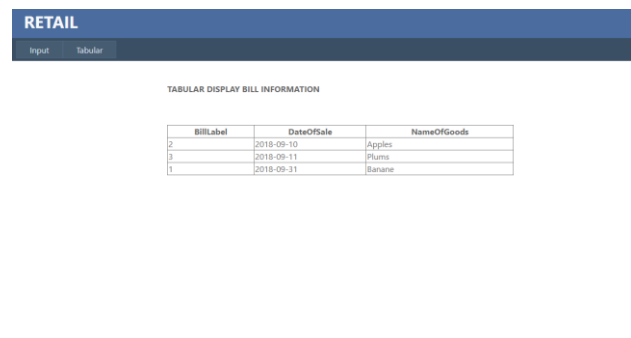

Figure 8. Layout of the basic screen for tabular display bill information

The data layer uses a database called Retail. DBMS (Database Management Software) must be used to create the database. Figure 9 shows the database schema. The database is used to enter and display data.

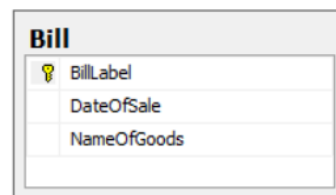

Figure 9. Database schema Retail with one table Bill

After creating the database, an XML document must be created. The XML document contains the goods codes, goods names, and their prices. In this case, the XML document represents the price list of the vendor, who will use the web service. After creating the database and XML, it is necessary to create a project called Database Class in Visual Studio. The project type to create a Data Class is Class Library. The data class contains two classes. One class is called clsRetail, and it defines the types of variables, and their getters and setters, which serve to be entered i.e. read the data. After creating the clsRetail class, the clsRetailDB class is created, which is used to work with the base. It contains the INSERT INTO for data entry, as well as the LoadAll method for tabular display of data. When creating classes, you need to build the Data Class project, and get a file with a DLL extension, which contains a set of functions and classes.

After creating a data class, a web service needs to be created. An XML document that was created before must be imported into the web service. After that, methods are written, which read us the data from an XML document. The first method, and one of the more important ones, is GiveAllGood. A DataSet is created that contains all the data to be displayed, and after that it is necessary to write the path to the XML document. After that, another DataSet called GiveNameOfGoods is created. It is necessary to load XML into the data set. The filtering of the datasheets is then performed. The name of the goods will be displayed, via the goods code. The same principle creates a DataSet GiveCodeOfGoods. The goods code is displayed via Name of Goods. One of the more important methods, i.e. the DataSet is the GivePrice. The price of the goods is shown by the name of the goods. After creating methods that return the appropriate XML data, a web service can be started.

When the web service is started, it starts in the desired web browser, in this case it is Google Chrome (Figure 10.). After starting the web service, all methods are displayed, i.e. the created DataSets can be tested.

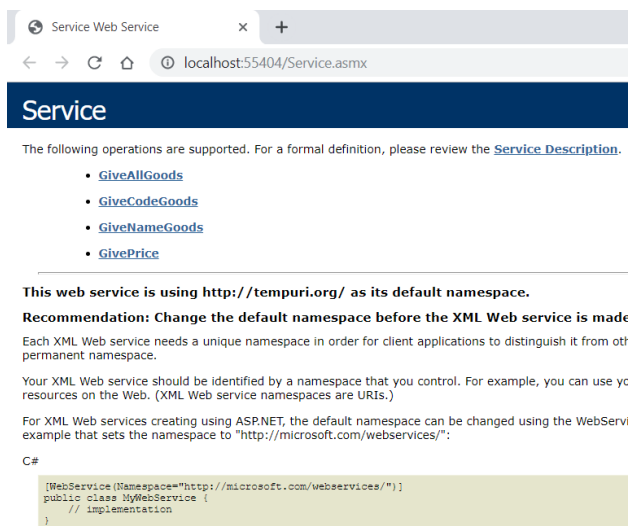

Figure 10. Web service layout in Google Chrome

In order to test the DataSet GiveAllGoods it necessary to click the Invoke button (Figure 11.)

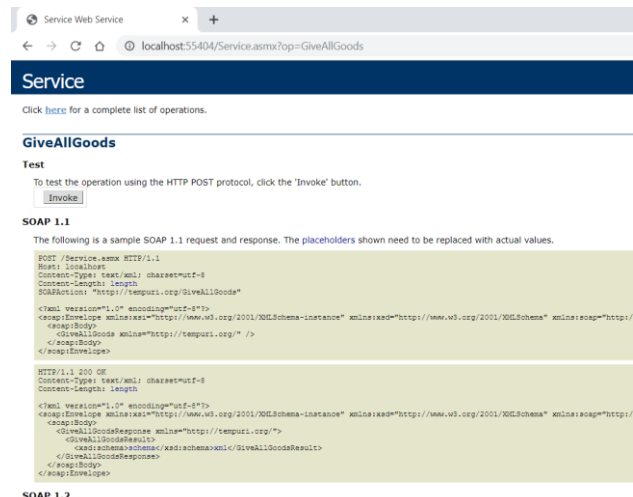

Figure 11. Testing the DataSet GiveAllGoods

When testing the DataSet GiveAllGoods as a result, the entire XML document with its structure and division is displayed (Figure 12.)

After the Data Class and Web services, it is necessary to create a User Interface, and the project is of ASPX WEB form. The user interface is displayed to the user. The user interface must connect to database Retail that was initially created. It is necessary to enter the correct computer name as well as the server name in the web config. Web service must be started in order to use the user interface. In order to use the web service it must be added as a service reference. It is added by running the web service and copying its http://localhost:55404/Service.asmx address, and pasting it when adding a service reference. When pasted, it must be given the same view as when launched in the web browser (Figure 13). After that, is needs to add a DLL from the data clas, which contains all the functions and classes.

Combo box control Name of goods is filled by the method of FillComboOfGoods, which uses the WSSupplierPricelist. A web service is defined to use an XML document that contains the required data. When Name of goods is selected, and when the value of the choice is displayed, on this basis the price in the price label is printed, with the help of the WSSupplierPricelist web service.

The ddlNameofGoods\_SelectedIndexChanged method is used for this. The data entry is performed by having RecordData, which uses the classes Retail and clsRetailDB. The classes are added to the User Interface via DDL Data Classes. In order to enter data, it must be verified with the btnRecord, which has the btnSnimi\_Clik method. The method reads data from the form and enters it into the database.

```

    <DataSet xmlns="http://tempuri.org/">
      <xsd:schema xmlns="" xmlns:xs="http://www.w3.org/2001/XMLSchema" xmlns:msdata="urn:schemas-microsoft-com:xml-msdata" id="Pricelist">
        <xsd:element name="Pricelist" msdata:IsDataSet="true" msdata:Locale="en-US">
          <xsd:complexType>
            <xsd:choice minOccurs="0" maxOccurs="unbounded">
              <xsd:element name="Goods">
                <xsd:complexType>
                  <xsd:sequence>
                    <xsd:element name="GoodsCode" type="xs:string" minOccurs="0"/>
                    <xsd:element name="NameOfGoods" type="xs:string" minOccurs="0"/>
                    <xsd:element name="Price" type="xs:string" minOccurs="0"/>
                  </xsd:sequence>
                </xsd:complexType>
              </xsd:element>
            </xsd:choice>
          </xsd:complexType>
        </xsd:element>
      </xsd:schema>
      <diffgr:diffgram xmlns:msdata="urn:schemas-microsoft-com:xml-msdata" xmlns:diffgr="urn:schemas-microsoft-com:xml-diffgram-v1">
        <Pricelist xmlns="">
          <Goods diffgr:id="Goods1" msdata:rowOrder="0" diffgr:hasChanges="inserted">
            <GoodsCode>1</GoodsCode>
            <NameOfGoods>Banane</NameOfGoods>
            <Price>120</Price>
          </Goods>
          <Goods diffgr:id="Goods2" msdata:rowOrder="1" diffgr:hasChanges="inserted">
            <GoodsCode>2</GoodsCode>
            <NameOfGoods>Pears</NameOfGoods>
            <Price>100</Price>
          </Goods>
          <Goods diffgr:id="Goods3" msdata:rowOrder="2" diffgr:hasChanges="inserted">
            <GoodsCode>3</GoodsCode>
            <NameOfGoods>Plums</NameOfGoods>
            <Price>40</Price>
          </Goods>
          <Goods diffgr:id="Goods4" msdata:rowOrder="3" diffgr:hasChanges="inserted">
            <GoodsCode>4</GoodsCode>
            <NameOfGoods>Apples</NameOfGoods>
            <Price>70</Price>
          </Goods>
          <Goods diffgr:id="Goods5" msdata:rowOrder="4" diffgr:hasChanges="inserted">
            <GoodsCode>5</GoodsCode>
            <NameOfGoods>Mandarins</NameOfGoods>
            <Price>90</Price>
          </Goods>
        </Pricelist>
      </diffgr:diffgram>
    </DataSet>
  
```

Figure 12. XML result invokes GiveAllGoods methods from the Web service – in a form suitable for loading as DataSet.

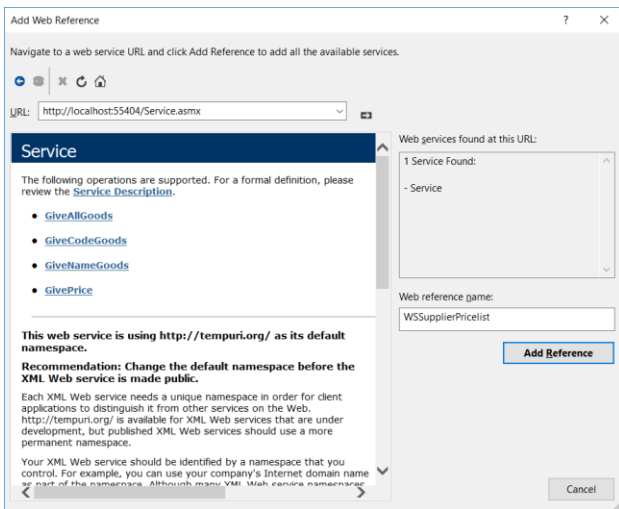

Figure 13. Adding a service reference WSSupplierPricelist

## V. CONCLUSION

In this paper, from a theoretical point of view, technological solutions that enable interoperability, that is, data exchange between different pieces of software or software implemented by different manufacturers, are analyzed.

In the empirical part, a prototype application was implemented that illustrates the implementation of a web service associated with a web application. The specific

example discussed relates to data exchange problems between the retailer and the wholesale or supplier. The problem arises when retailers have at all times an up-to-date list of goods with valid prices. The implemented web service in this example provides 24 hours availability of data on available goods and prices. The information provided by the web service is loaded within the user interface by calling the web service and displayed in a combo box. Also, choosing the right merchandise name automatically re-invokes the web service to read the price values and display them in the user interface. This illustrates how the vendor / wholesale information system connects to the retailer and achieves interoperability.

As a further improvement of the realized prototype, the possibilities of deploying web services within different software functions would be expanded. It is possible to upgrade an existing prototype by transferring web service calls to a separate sublayer of the presentation layer related to presentation logic. Also, by introducing a layer of business logic, different web services could be consulted to check constraints and implement business rules.

## REFERENCES

- [1] Medjahed, B., et al., Business-to-business interactions: issues and enabling technologies, the VLDB Journal, vol. 12, no. 1, pp. 59-85, 2003.
- [2] D. Konstantas, J. P. Bourrières, M. Léonard, N. Boudjlida, Interoperability of Enterprise Software and Applications, Proceedings of the I-ESA Conferences, 2006.

- [3] F.B. Vernadat, Enterprise modelling and integration: principles and applications, London: Chapman & Hall, 1996.
- [4] S. Nešković, N. Aničić, S. Babarogić, Materijal u elektronskoj formi za predmet Modelovanje poslovnih procesa, FON, Beograd, januar 2009.
- [5] D. Pilipović, Interoperabilnost pri modelovanju preduzeća – seminarski rad, Fakultet organizacionih nauka, Beograd, 2008.
- [6] Magma Web Development Company. URL: <http://sr.magma.rs/blog/web-aplikacije/sta-je-to-web-aplikacija> (accessed 02.09.2019.)
- [7] e-Learning. URL: <https://goo.gl/AXo33j> (accessed 02.09.2019.)
- [8] SearchITOperations. URL: <https://goo.gl/xUcKhz> (accessed 03.09.2019.)
- [9] Techopedia - The IT Education Site. URL: <https://www.techopedia.com/definition/24067/business-software> (accessed 03.09.2019.)
- [10] K. Kosanke, ISO Standards for Interoperability: a Comparison, CIMOSA Association, Germany
- [11] L. Guijarro, Interoperability frameworks and enterprise architectures in e-government initiatives in Europe and the United States, Government Information Quarterly, vol. 24, pp. 89-101, 2007.
- [12] A. Lisboa, D. Soares, E-government interoperability frameworks: a worldwide inventory, Procedia Technology, pp. 638-648, 2014.
- [13] T. A. Pardo, T. Nam, G. B. Burke, E-government interoperability, University at Albany, vol. 30, pp. 7-23, 2012.
- [14] H. Panetto, J. Cecil, Information systems for enterprise integration, interoperability and networking: theory and applications, vol. 7, 2013.
- [15] H. Panetto, Towards a classification framework for interoperability of enterprise applications, International Journal of CIM, pp. 727-740, 2007.
- [16] R. J. Gonçalves, A. Grilo, Systematization of interoperability body of knowledge: the foundation for EI as a science, Enterprise Information Systems, pp. 7-32, 2013.
- [17] Amazon. URL: <https://www.amazon.com/> (accessed 04.09.2019.)
- [18] Microsoft Office. URL: <https://products.office.com/Sr-latn-rs/home> (accessed 04.09.2019.)
- [19] Dropbox. URL: <https://www.dropbox.com/> (accessed 04.09.2019.)



# WPF Application Development on the Football Match Example

S. Mihajlović, E. Brtka and V. Brtka

Technical Faculty “Mihajlo Pupin”, Zrenjanin, Republic of Serbia  
mihajlovicsinisa25@gmail.com, eleonorabrtka@gmail.com, brtkav@gmail.com

**Abstract** – This paper describes application development using the Windows Presentation Foundation (WPF). The concept of WPF and its application are explained. This paper is an example of developing a WPF application based on a football match. The example was done using the SQL Server Management Studio and Visual Studio 2017 software tools.

## I. INTRODUCTION

*Windows Presentation Foundation* (WPF) was developed by Microsoft and is a graphical subsystem for rendering the user interface in Windows based applications. WPF is a replacement for Windows Forms. WPF uses DirectX, offering a clear distinction between user interface and business logic, thus facilitating application development and design. WPF uses XAML (*eXtensible Application Markup Language*), which defines and links different UI (*User Interface*) elements. WPF applications can be developed as desktop programs or as embedded objects in a website. The main features of WPF are animations, 3D, skins / themes that may not be used to develop business applications. UI applications become interesting and have more attractive design [1].

XAML is a language designed to design user interfaces and outputs. In combination with other programming languages, it is used to create desktop applications. The design is facilitated by the introduction of XAML and WPF. An essential part of WPF is XAML. By creating a window or page, it consists of an XAML document and the code behind the file that creates the window / page together. The XAML file describes an interface with all elements, and the code behind manages all events. The WPF architecture consists of two frameworks, one manageable and one unmanageable. The presentation framework is in the governing API slime for control, appearance, data binding and visual display. The unmanageable framework has functionality such as composition and rendering [1].

## II. RELATED WORK

Windows Presentation Foundation helps developers create attractive and user interface. WPF is a unified platform that helps designers to be active participants in creating a user interface. Technologically people are the most concerned about technology. Software professionals are more concerned with how an application works, not how it communicates with its users. Productivity can

enhance a better user experience through a better interface, as well as create loyal customers, increase website sales, and more. Requirements for user interfaces are still progressing. Graphics and media are widespread and usable, and the Web has conditioned a generation of people to expect easy interaction with software. People are conducting and increasingly interacting with apps, which is why it matters how they look. The technology used to create user interfaces must be advanced [2].

Through the UI layer, users interact with the application. The user interface layer works with the business logic layer that works with the data access layer. WPF is used to develop business productivity applications on desktops running Windows 7 and higher. The goal of productivity applications is for business users to search and update data stored in a database. It consists of a set of application development features that includes Extensible Application Markup Language (XAML), controls, data connectivity, and layout. Windows are objects with visual interfaces that are painted on a screen to allow users to interact with programs. .NET Windows has properties, methods and events. Properties determine its appearance. The window method defines its behavior. The events in the window define the interaction with the user or other objects. Controls are components with visual interfaces that give users a way to interact with the program. The window is a container control, which contains other controls [3].

The developers 'playground is growing fast. One of Microsoft's new platforms is the Windows Presentation Foundation. WPF provides developers and designers with a unique platform to create rich media applications that make the most of the graphical capabilities of modern PC hardware. The command line interface is no longer used, but today's application users expect a visually appealing and streamlined interactive experience [4].

WPF enables rich user interface creation including media of all kinds such as animation, video and audio. Using a new tagging syntax called XAML and a new suite of Microsoft Expression Blend design tools, developers and designers can now easily collaborate on projects. Before WPF, designers would create graphical elements for the application and hand over those elements to developers in the form of images. The developers had to model the UI according to them. Designers can model UIs using Expression Blend, save the design as an XAML file, and simply submit the file to a coding developer in Visual Studio using WPF [4].

MVVM (Model - View – View Model) design pattern is based on the Presentation Model design pattern. John Gossman created it for XAML and WPF. The MVVM pattern enables separation of business logic (model) from the UI (view) by adding an abstraction layer that encapsulates all the logic required for the UI and processes the requests of the user performing actions on the model or retrieving data. When MVVM is used, the view is displayed by XAML. The view depends on the view model. There should be no UI elements or other dependencies associated with the view in the view model. The view model's public interface should be well defined. Any change in view of the model's public interface could result in a change of view. The view model works with the application service layer to modify or receive data from the model. A domain model or model should only contain business domain-specific. It is important that no UI-related code from the view or view model be pulled into the domain model. The domain model should be isolated from any non-business model code. Figure 1 shows the communication between the different parts of the MVVM design pattern [5].

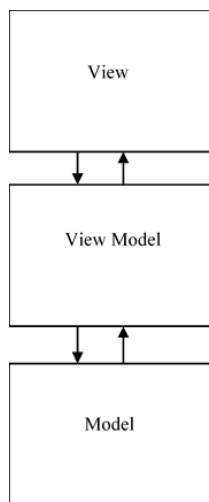

Figure 1. The flow of communication when using the MVVM design pattern [5]

View declaratively creates an instance of the view model. The view model's properties will be data-bound to controls declared in the view. The data binding will allow for automatic updating of view control display values as well as binding user interface control events and commands related to user interaction to the methods and properties of the view model. The view model will respond to user interaction events to interact with the model. The view model will communicate with the model to make changes and report updates to the model. This allows for a complete separation of the user interface, presentation layer logic, and domain model of your application [5]. WPF is a new presentation framework, integrating other frameworks that exist before it User, GDI, GDI + and HTML, and is influenced by a suite of Internet-oriented tools such as Adobe Flash and Windows applications such as Microsoft Word [6].

### III. THE SOLUTION

The example chosen to illustrate the development of a WPF application is an example of a football match. The user enters information about the football player, football clubs, coaches, football leagues and football matches. The technologies used to implement the example are SQL Server Management Studio to create the database and Visual Studio 2017 to create the WPF application.

Creating a WPF application creates a *MainWindow* window. Five more windows need to be created which are as follows: *Footballer*, *Coach*, *League*, *Club* and *Match*. The application consists of a set of tables that are linked to one database (Figure 2). Each table has its name, and data of a specific type that make up a given table contained in the database.

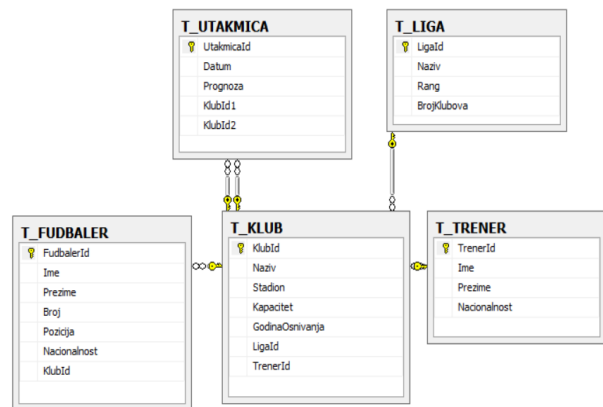

Figure 2. Scheme of the Football match database

After creating the database, you need to create a connection string, which allows connection to the database. It is necessary to add a connection string in *App.config* and a *Data Source* in it.

When creating a connection string, a reference must be added that windows can work with the configuration database containing the path to the database. The reference is added by right-clicking on *References - Add Reference* and the *Reference Manager* opens in which it is necessary to mark *System Configuration* (Figure 3).

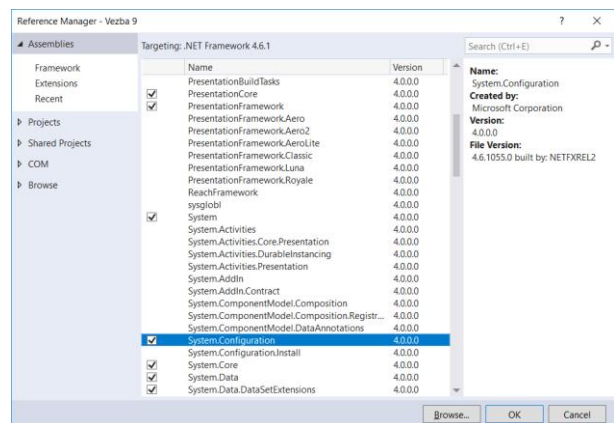

Figure 3. Adding a System Configuration reference

In the *MainWindows*, a *Menu* tool with a “*Data*” field is inserted. The “*Data*” field contains five sub-fields through which windows for entering information on

football players, clubs, coaches, matches and leagues are accessed (Figure 4).



Figure 4. MainWindow layout

The characteristics of a football player are: Name, Surname, Number, Position, Nationality and ClubId. The first five features are textBox types and are typed. The ClubId field is of the comboBox type. ComboBox reads the information contained in the Club window. ComboBox ClubId reads ClubId, and the DataGridFootballer displays the Club Name and Year of Establishment.

Club must be created in order to read club data. This window contains the DataGrid control, which allows you to view data for all added football players in the database, buttons for adding, changing and deleting data from the database. Figure 5 shows the layout of the footballer window.

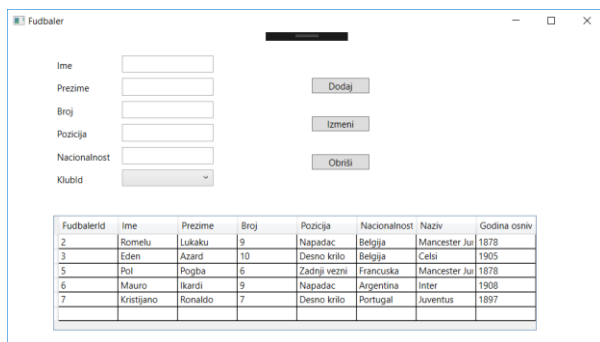

Figure 5. Layout of the Footballer window

The characteristics of the club are its: Name, Stadium, Capacity, Established, League and Coach. The first four features are textBox types and are typed. The LeagueId field is of the comboBox type, as is the CoachId field. ComboBoxes read the information contained in the League and Coach windows.

The comboBox League reads LeagueId, and the DataGridClub displays the League Name and Rank, and the comboBox Coach reads the CoachId, and in the DataGridClub displays the Coach Name and Surname. The league and coaches must be created in order for the league and coach information to be read. This window also has a DataGrid control, which allows you to view data for all the clubs added to the database, buttons for adding, changing and deleting data from the database. Figure 6 shows the layout of the club window.

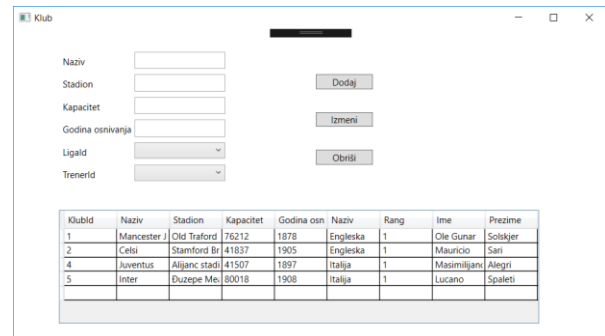

Figure 6. Layout of the Club window

The characteristics of the coach are: Name, Surname and Nationality. All field characteristics are of type textBox and are typed. This form also includes the DataGrid control DataGridCoach, which allows you to view data for all added coaches in the database, buttons for adding, changing and deleting data from the database. Figure 7 shows the layout of the coach window.

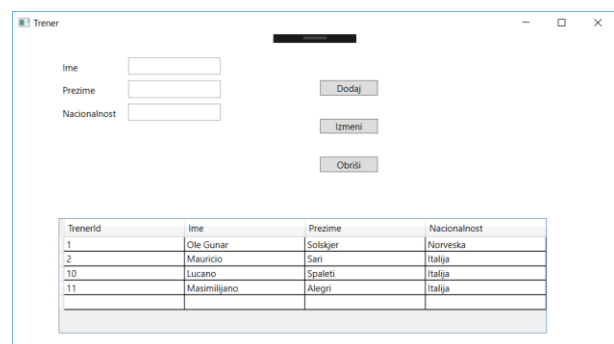

Figure 7. Coach window layout

Features of the league are its: Name, League Rank and Club Number.

All three characteristics are of type textBox and are typed. This window also contains the DataGrid control of the DataGridLeague, which allows you to view data for all leagues added to the database, buttons for adding, changing and deleting data from the database. Figure 8 shows the layout of the league window.

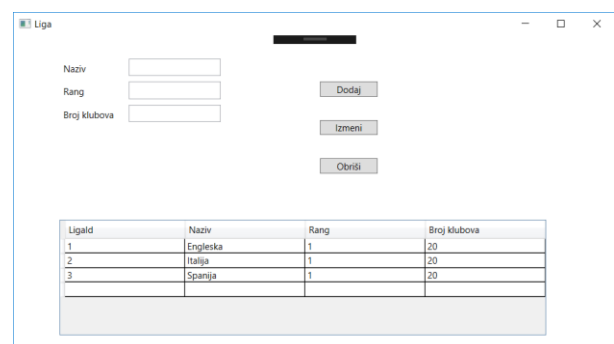

Figure 8. Layout of the League window

The game features are: Date, Weather, ClubId1 and ClubId2. Weather forecast is a characteristic of the textBox field type and is typed. The ClubId1 and ClubId2 fields are of the comboBox type. ComboBoxes read the information contained in the Club window. ComboBox ClubId1 reads ClubId, and the DataGridMatch shows

Stadium, Stadium Capacity, Club Name as well as League Name, while comboBox ClubId2 reads ClubId, and in the DataGridMatch shows the Club Name.

Club must be created in order to read club data. This window also includes a DataGrid control of the DataGridMatch, which allows you to view data for all matches added to the database, buttons for adding, changing and deleting data from the database. Figure 9 shows the layout of the match window.

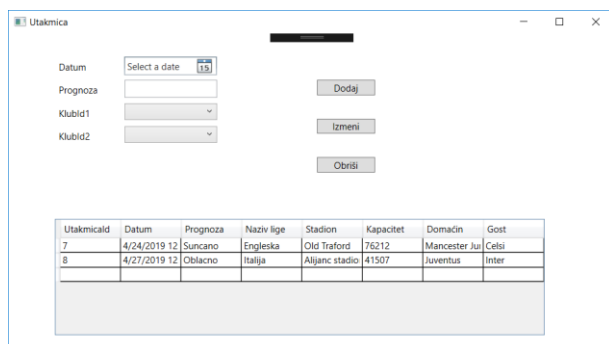

Figure 9. Match window layout

#### IV. CONCLUSION

This paper explains the role of WPF from a theoretical point of view, as well as its advantages over other programming models. The benefits are easier programming and user interface creation. The business is divided into business logic and programming. In the empirical part, a prototype application was applied that illustrates the application of developing a WPF application in the example of a football match. The application is linked to a database, and has a tabular display, as well as entering, editing and deleting existing data.

Opportunities for further development of the application, for example, are to add more referees in the Match window. To allow only clubs from that league to be selected when a league is selected, and that ClubId1 and ClubId2 can't be the same clubs. In the Footballer window, a player who is injured, has a yellow card, a red card or is suspended may be added. In addition, the Team and Competition window can be added. These are some of the options available to improve this program.

#### REFERENCES

- [1] S. Mihajlović, E. Brtko, "Application Development Using WPF", 10. ITRO – International Conference on Information Technology and Development of Education, Zrenjanin, June 29, 2019
- [2] Microsoft, Introducing Windows Presentation Foundation. URL: <https://msdn.microsoft.com/en-us/library/aa663364.aspx> (accessed 22.09.2019.)
- [3] D. Clark, "Beginning C# Object-Oriented Programming", Apress, March 29, 2013
- [4] C. Andrade, S. Livermore, M. Meyer, S. V. Vliet, "Professional WPF Programming: .NET Development with the Windows Presentation Foundation", Wiley Publishing Inc., May 2007.
- [5] B. James, L. Lalonde, "Pro XAML with C# Application Development Strategies", Apress, 2015
- [6] I. Griffiths, C. Sells, "Programming Windows Presentation Foundation", O'Reilly Media, September 2005.

# Application and Difference of Raster and Vector Graphics

S. Mihajlović, I. Berković

University of Novi Sad, Technical Faculty "Mihajlo Pupin", Zrenjanin, Republic of Serbia  
mihajlovicsinisa25@gmail.com, ivana.berkovic62@gmail.com

**Abstract - This paper presents what raster and vector graphics are, as well as their role. The image formats are shown, as well as their division into vector or raster types. The application of raster and vector graphics in programs is described. In addition, raster and vector graphics are compared, and their advantages and disadvantages are presented.**

## I. INTRODUCTION

Computer graphics are pictures and films created using computers. Computer graphics is a sub-field of Computer Science which studies methods for digitally synthesizing and manipulating visual content. Computer graphics is rapidly evolving and expanding since the advent of personal computers. The highly developed ability to recognize shape in humans makes computer graphics one of the most natural ways to communicate with your computer. Raster graphical interaction has become a standard component of computer use interfaces. Computer graphics include the creation, storage and use of models and images of objects. Computer graphics models and objects come from different fields: nature, science, engineering, abstract concepts, etc. [1]

Raster graphics are based on a two-dimensional grid of pixels. An image is displayed as a discrete set of tiny elements of an image (*Pixel – PICTure ELeMent*), and each pixel is assigned a number, representing the color of the pixels. Vector graphics use basic geometric figures (points, directions, circles, arcs, polygons) to display an image. This allows the image to be enlarged without losing image quality, for unlike raster graphics [2].

In a computer sense, an image is the product of a graphic program that is executed with the help of a computer. An image is loaded into the computer's memory space in one of three ways:

- By uploading an image from a digital camera's memory, directly from the camera or from another memory space (Internet ...).
- Scanning with a peripheral called a scanner.
- By creating an image using a program to create or process images [3].

## II. RELATED WORK

Computer graphics is nowadays used in various fields of economy, administration, education, entertainment and

everyday home life. The field of application is expanding rapidly with the spread of computers. In vector graphics, building elements are objects (straight and curved lines, open and closed, filled and unfilled geometric shapes) that can overlap, overlap, or fit to form an image. Computer internal representation of such images is a series of mathematical vector formulas that describe the manner and order of drawing objects, hence the name of the type of graphics itself. Vector graphics find their application in CAD programs for designers and there is no alternative if we want to simulate a three-dimensional world with a computer. Vector graphics are completely inappropriate for displaying scenes consisting of so many details that do not fit into a mathematically descriptive link (photography). In these cases, raster graphics are used. Raster graphics use the so-called basic element of the image, pixel, which has unique values of color and or intensity. A raster image is an image composed of points of different brightness levels or different colors [7].

Raster graphics or bitmaps are data that represent a rectangular grid of pixels or colored dots, on a graphical output device such as a monitor or on paper. Each color of an individual pixel is separately defined such that (for example) RGB images contain three bytes per pixel, each byte contains one specially defined color. Red Green Blue - this means that each color has its own value, changing the value yields colors other than these three basic ones. The higher these values the image will take up more space. If the image is black and white, this means that the pixel requires only one bit as opposed to a color image that requires three bytes (RGB) per pixel. Therefore, black and white images are smaller in terms of space. A raster RGB image, each pixel has its own R, G and B value, which is measured in percent [1].

Vector images can scale without damage and are relatively small. It only takes a few hundred kilobytes. Printing a vector illustration in small size gives it a great and beautiful quality, and if enlarged to a large size it still looks perfect. Raster images depend on the resolution. The image is damaged by increasing the image size. The pixel is a small part of the raster image. Computer pixels are square in shape and rectangular on TV. The pixel on the computer image contains the tonal information of the same location in the original image. Pixels can represent monochrome information, duotone information, RGB color information, CMYK (cyan, magenta, yellow, black) colors and other colors. The computer displays the pixel so that the computer considers the correct color for that

small part of the original image. Bitmap represents the original image, but in the digital world [12].

The quality of a single raster image determines the total number of pixels (resolution) as well as the number of values for each individual pixel (color depth). If the color depth is greater, more shades can be displayed, which means a better image as well as a more authentic display. Images require a lot of memory, which is why various types of compression are used. Bitmap (BMP) is an uncompressed file that does not use any type of compression, the images in this format are very large, unlike the BMP format much more popular and more commonly used is the JPEG (JPG) format which compresses the image without noticing a loss in quality though it's impossible to do, but it's close to reality. A raster image cannot be enlarged to a higher resolution without loss of quality, which is not the case with vector graphics. Raster graphics are more practical than vector graphics for photographers and ordinary users. Vector graphics are used by graphic designers and DTP editors. The first versions of the monitor could display from about 72 to 130 pixels per inch (PPI), while today's printers can print 2400 dots per inch (DPI). Vector graphics or geometric shaping is a way of displaying an image using geometric shapes such as points, lines, curves, and polygons that are based on mathematical equations. In general, vector shapes are much easier to remember than demanding bitmap images. Almost all of today's computer graphics represent a vector image in raster format. The raster image is stored in memory and contains data for each pixel of an image. The term vector graphics has been mostly used in the context of two-dimensional computer graphics. Almost every 3D rendering was done using a 2D

vector technique (using dots, lines and polygons). Vector graphics are good for removing unnecessary details from a photo [1].

The raster image is represented approximately by dividing the surface of the image by lines parallel to horizontal and vertical axis in the grid of squares - pixels. The pixel is characterized by the intensity of lighting and colors. How many images will take up space it does not depend on the computer memory just from its complexity but rather than the number of pixels and number the colors available. Vector graphics or geometric shaping is a way of displaying an image using geometric shapes such as points, lines, curves, and polygons that are based on mathematical equations. Unlike bitmap images, the vector format is reusable because it allows printing on any format, with extreme ease and flexibility, making it unrivaled in creating and storing logos. As much as it works on advancement of the programs, it is not possible to achieve photorealistic, which is also the only, great disadvantage of vector views. The most famous vector formats are EPS, AI, PDF, etc. [3]

Scalable Vector Graphics (SVG) is a standard for vector graphics developed by World Wide Web Consortium (W3C). The standard is very complex, many browsers and programs now offer support for rendering SVG data, although complete implementation is still very rare. Metafile is a generic name for a format that contains multiple types of data. Typically, raster and vector formats are combined. The most popular is Adobe PDF [6].

Table 1 illustrate most important images formats.

TABLE I. MOST IMPORTANT IMAGES FORMATS [3]

	Format	Vector or Raster	Description
.BMP	Windows Bitmap	Raster	Used to view and store Windows images.
.CGM	Computer Graphics Metafile	Vector	A format developed by the collaboration of various standardization organizations. It is supported by many software companies.
.DCX	Windows Images	Raster	Format for multiple '.PCX' files (Windows).
.DXF	Data Exchange File	Vector	Format created by AutoDesk. Almost all PC based CAD (Computer Aided Design) based systems support DXF.
.EPS	Encapsulated Postscript	Vector, often with a Raster header	Format for PostScript language. EPS uses a combination of PostScript commands and TIFF or PICT format.
.GIF	Graphics Interchange Format	Raster	This format can be used on different platforms, and is often used to store images for the WWW. Because the record is relatively small, images are quickly transmitted over the Internet. However, the GIF is limited to 256 colors, and colors are not displayed on all platforms.
.JPG	Joint Photographic Experts Group	Raster	An international standard used for digital image compression. The files are relatively small, depending on the degree compression. This is an original image format that cannot be restored.
.PCX	PC Paintbrush	Raster	Format created by Zsoft. Supported by many Windows applications, as well as many optical scanners and fax modems.
.PIC	Lotus Picture File	Vector	A relatively simple graphic format developed by Lotus to display the graphics generated by Lotus 1-2-3. PIC is supported by many PC applications.
.PICT	Picture Format	Vector	A format for Macintosh graphics files developed by Apple Computer. It is supported by all graphics programs that working on a Macintosh.
.PNG	Portable Network Graphics	Raster	A more advanced version of the .GIF format.
.TIFF	Tagged Image File Format	Raster	This format is used to save and exchange between 'desktop publishing' and 'graphic design' applications. TIFF also support different platforms, such as Microsoft Windows and Macintosh. It is also used for scanning image because it supports all sizes, resolutions and color depths.
.WMF	Windows Metafile	Vector, may also contain a raster image	Windows image storage and sharing format applications.
.WPG	WordPerfect Graphic File	Vector	Format used by WordPerfect.

### III. APPLICATION OF RASTER AND VECTOR GRAPHICS

Raster images can be inserted into vector programs, but their ability is modification and transformation in these programs is limited. For a generation of modification (retouching) of raster images raster programs are used. As the capabilities of these programs are based on the theory of photography combined with modern technology, to describe the capabilities of these programs than for vector programs. Corel Photo-Paint is part of the Corel software package intended for creating, retouching and processing raster images [3].

Although basic operations over raster graphics (resizing) color depths, cropping part of the image, image rotation) can be done using tools that are component of system software (*MS Paint*), for any serious interventions (contrast adjustment, histograms, imitation painting techniques) are used professional software, the most famous of which is Adobe Photoshop [2]. Figure 1 shows an example of using Adobe Photoshop software, while Figure 2 shows the use of Adobe Illustrator software.



Figure 1. Example of using Adobe Photoshop raster graphics software [10]

Vector graphics software is used for DTP (*DeskTop Publishing*), graphic design and CAD (*Computer Aided Design*), or computer-aided design. The first one the commercial application of CAD was in large companies in the automotive and aviation industries, and in electronics. Back then, only large corporations could afford computers that could run complex calculations [2].

Catia is used for 3D modeling. Autodesk has created CAD software and its main purpose is 2D and 3D modeling, but it is also used for CAM (Computer Aided Manufacturing), computer-aided manufacturing and CAE (Computer Aided Engineering), computer-aided technology. CAE covers the use of computers in design, computer analysis and simulation [2]. In the most widespread programs, which are fully compatible and capable are to save the vector format, include Adobe Illustrator, Corel Draw, Macromedia Freehand and others. Bitmap image processing programs are numerous and most common Adobe Photoshop, Adobe Lightroom, Corel Photo-Paint, ultimately the case of Paint [5].

Gimp (GNU Image Manipulation Program) is an extremely high-quality graphic element processing

program that can be used in many ways: as a simple drawing program, as a professional image processing program, as an image renderer, as a graphic format converter. GIMP's main function is to edit bitmaps, but with it comes tools for working with vector graphics. It is primarily intended for the Linux platform (where it was popularly called "Photoshop for Linux"), and there are versions of it for the Mac and Windows platforms. Its user interface is a bit cumbersome and confusing, which may be its biggest drawback [8].

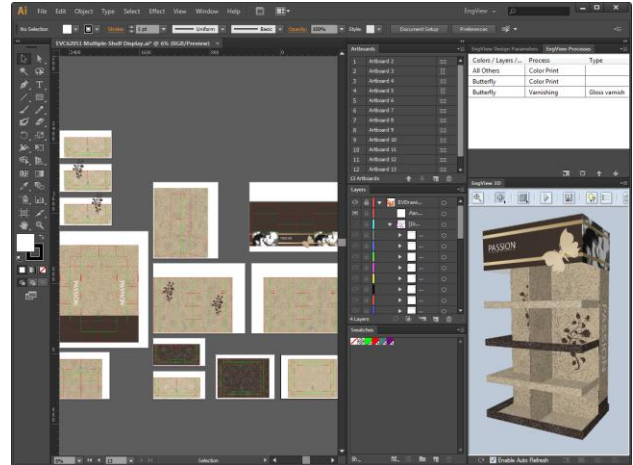

Figure 2. Example of using Adobe Illustrator software for vector graphics [11]

### IV. COMPARISON

Comparing raster and vector graphics, the following differences are observed: the first important difference is that the image quality decreases with increasing bitmap, while the vector image does not lose image quality, because every time the computer changes the value of all pixels is recalculated. For vector images, magnification is done by resizing the vector using arithmetic formulas, so that enlarging the image has no effect on the display quality. Another important difference is the size of the graphic file. Raster graphics images have a much larger file, while vector graphics allow for a much smaller file size [4]. Figure 3 illustrate an example of vector and raster graphics.



Figure 3. Example image shown in vector and raster graphics [9]

Vector graphics have many advantages over raster graphics:

- They need significantly less memory space,

- They are easy to manipulate, without losing shape and quality.
- When the vector image is enlarged, it does not lose a bit on the sharpness and quality of the image.
- If the raster image is reduced and then resized, some image details are permanently lost [7].

However, raster images are very suitable for adding fine effects to an existing image. Raster images are especially useful for displaying images with many details [7]. Vector graphics are used to create logos, illustrations and precise typography. Vector images come from graphics programs. An image cannot be scanned or saved as a vector file without special software. The vector can be easily converted to a raster. Most vector programs offer rasterization options. Opening a vector file in an Adobe Photoshop raster program will be automatically rasterized [13].

## V. CONCLUSION

Computer graphics is constantly advancing, and as technology evolves, its use is expanding. There is a division into raster and vector graphics, and each has its own role. Raster graphics consist of pixels, while vector graphics consist of mathematical formulas. The raster data takes up a lot of space, and if the raster image is enlarged, it loses quality. Vector images take up little space, it is possible to enlarge and reduce the image without losing quality. Therefore, it is ideally suited for corporate logos, geographical maps and other objects that often need to be resized. Raster and vector graphics are used in various programs. The most popular program used to work with raster images is Adobe Photoshop, while to use vector images is used Adobe Illustrator, Corel Draw and others.

Computer graphics is used in virtual reality, which brings innovations in architecture, sports, medicine, the arts and entertainment. Virtual reality is at the beginning of development, but in the future, it will be a daily occurrence, and anyone will be able to use it. Developing computer graphics enhances the quality of photos, movies, games, and software on a daily basis.

## ACKNOWLEDGMENT

Ministry of Education, Science and Technological Development, Republic of Serbia financially supported this research, under the project number TR32044: "The development of software tools for business process analysis and improvement", 2011-2019.

## REFERENCES

- [1] V. Gavranic, Computer Graphics - Introduction: Content of computer graphics (Original in Serbian: Računarska grafika – Uvod: Sadržaj računarske grafike), November 2011.
- [2] S. Lemeš, Computer Graphics (Original in Serbian: Računarska grafika), 2010.
- [3] Image processing (Original in Serbian: Obrada slika). URL: <https://bit.ly/2oxPjL2> (accessed 28.09.2019.)
- [4] A. Đurišić, PixelByPixel software for visualizing raster algorithms for computer graphics (Original in Serbian: Programski paket

- PixelByPixel za vizualizaciju rasterskih algoritama računarske grafike), Univerzitet u Nišu, Prirodno-matematički fakultet, 2018.
- [5] Bitmaped graphic formats supported on the web (Original in Serbian: Bitmapirani grafički formati podržani na webu). URL: <http://www2.viser.edu.rs/download.php?id=15895> (accessed 28.09.2019.)
  - [6] I. Pavlović, Application of vector and raster graphics in photorealistic 3D rendering (Original in Serbian: Primena vektorske i rasterske grafike u fotorealističnom 3D renderovanju), Univerzitet Singidunum, Beograd, 2013.
  - [7] Application of computers in graphics (Original in Serbian: Primena računara u grafici). URL: <https://bit.ly/2nU8gYn> (accessed 29.09.2019.)
  - [8] Link University. URL: <https://bit.ly/2nTIUtG> (accessed 29.09.2019.)
  - [9] GraphicMama's Blog. URL: <https://bit.ly/2ptCv95> (accessed 30.09.2019.)
  - [10] SLR Lounge. URL: <https://bit.ly/2ppVd1b> (accessed 30.09.2019.)
  - [11] EngView Systems. URL: <https://bit.ly/2nKZVX5> (accessed 01.10.2019.)
  - [12] B. P. Lawler, Vector that, Charlie!, 2002.
  - [13] Bokland Custom Visuals, Raster vs. Vector 24 May 2018.



# Internet Marketing Strategies and Managing Customer Satisfaction

M. Bakator<sup>1</sup>, D. Đorđević<sup>1</sup>, D. Čoćkalo<sup>1</sup> and S. Bogetić<sup>2</sup>

<sup>1</sup> University of Novi Sad, Technical Faculty "Mihajlo Pupin", Đure Đakovića bb, 23000, Zrenjanin, Republic of Serbia

<sup>2</sup> Belgrade Business Academy of Vocational Studies, 11000 Belgrade, Kraljice Marije 73, Republic of Serbia  
mihalj.bakator@uns.ac.rs; dejan.djordjevic@tfzr.rs; dragan.cockalo@tfzr.rs; srdjan.bogetic@bpa.edu.rs

**Abstract** - Internet marketing or digital marketing is a necessity when it comes to developing long-term business strategies. The final result of business activities should be a satisfied customer. When it comes to Internet marketing strategies, customer feedback is more easily attainable compared to field surveys. Now, in order to achieve and maintain competitiveness, it is necessary to effectively manage customer satisfaction. In this paper, a brief theoretical overview of literature in the domain customer satisfaction and Internet marketing strategies is conducted. The main goal was to develop a theoretical model which demonstrates the basic dynamics in the customer satisfaction management process within an Internet marketing strategy. In addition, the paper provides an adequate basis for future research in the domain of Internet marketing and customer satisfaction management. For the reader, the paper provides an introductory model on managing customer satisfaction.

## I. INTRODUCTION

Internet marketing or digital marketing is a new standard when it comes to developing effective marketing strategies. Without an online presence companies can't achieve competitiveness on the market. Reaching customers through the Internet is an important feature which is not easily available with traditional, non-digitalized marketing. Further, customers are the central element of every marketing strategy, regardless if it's online or not [1]. Therefore, it can be argued that Internet marketing strategies are a digitalized way of developing relationships between enterprises, customers and consumers. In addition, it can be proposed that customers are a key part in the complexity that is the modern business environment. When it comes to the Internet, it is characterized by a hyper-distribution of information. Consumers look up on information when they are interested about purchasing a product or service. Customers who already used a particular product or service share their reviews. These reviews can be devastating to a marketing campaign, thus effective customer satisfaction management is crucial for long-term success.

Furthermore, marketing capabilities have a tremendous effect on business performance (sales growth, market share, profitability, **customer satisfaction**, and return of investment) [2]. This indicates that in order to achieve business excellence, an enterprise has to effectively manage its marketing strategy which will have an overall positive influence on marketing capabilities. In

addition, an important metric of marketing strategy effectiveness is customer satisfaction. In the context of Internet marketing strategies, customer satisfaction is affected by customer-to-customer relationships. The rising domain of online reviews heavily affects customers' satisfaction [3].

In this article, customer satisfaction management within an Internet marketing strategy is analyzed. The goal was to develop a theoretical model which will present the dynamics between the main elements of the customer satisfaction management process within an Internet marketing strategy environment. Excluding the introduction and conclusion sections, there are three main sections in this article. The first section includes a theoretical background on Internet marketing strategies and managing customer satisfaction. Here, a brief review of existing literature is conducted. Further, the second section includes the theoretical model that depicts the process of customer satisfaction management within an Internet marketing strategy. The goal here was to concisely present the dynamics which take place in this process. Finally, the third section discusses and suggests guidelines for managers and enterprises regarding effective customer satisfaction management. After these three main sections, conclusions are drawn, and future research is discussed.

## II. INTERNET MARKETING AND THE IMPORTANCE OF CUSTOMER SATISFACTION

The modern business environment requires enterprises to digitally transform in the context of how they manage and conduct their marketing strategies. Organizations have to choose the most adequate perspective for their marketing strategy, meaning that organizations should choose between customer-centric, strategic-centric, technology-centric and organization-centric strategies/approaches [4]. In accordance with the chosen marketing strategy, adequate actions are to be taken in order to "push" business processes towards achieving business goals. Which strategy and what kind of focus will be chosen, depends on the long-term business goals of the enterprise. Customer satisfaction is a result of integrated business actions which are conducted within a defined marketing strategy. Customer satisfaction is a result of multiple business actions which resulted in multiple fulfillment of needs and expectations of customers. Now, an enterprise can't suddenly implement a

new technology which would make it possible to conduct successful marketing strategies.

Digitally transforming an enterprise often requires reengineering of the business in order to successfully implement new technologies [5]. It is important for employees to collaborate in the transformation process in order to reduce stress and employee burnout [6]. Digital transformations include remapping the whole infrastructure in the enterprise. The importance of digital transformation is most evident on the market. Enterprises who lack it, can't compete with other enterprises, while digitally enhancing business activities provides a chance for achieving a competitive position on the market. The necessity for digital transformation also comes from the globalization process which indicates that enterprises have to implement and apply modern technologies in order to stay relevant on the market.

In a traditional marketing environment the customer-decision process and the process of selling products and services was generally simple. In the era of digital marketing, customer experience is affected not only by the product, but also by other customers and their reviews and opinions. Also, the company's presence on social media has also a big influence on customer experience, which further affects the development of customer loyalty [7]. Developing loyalty is the main goal of managing customer satisfaction, as loyalty often translates in reoccurring purchases and good recommendations and reviews. Therefore it is necessary for an enterprise to effectively manage the expectations and of their customers so there could be a bigger chance to develop customer loyalty, which would further positively affect business performance.

As mentioned previously, in order to successfully develop an Internet marketing strategy, enterprises have to align with information technologies. More precisely, Internet marketing strategies, or digital marketing strategies are the new norm, when it comes to marketing management. Enterprises have to integrate complex perspectives, as the digital marketing environment is far more dynamic compared to traditional marketing environments. The number of patterns to which an enterprise has to adapt is higher compared to non-digital strategies [8]. It can be argued that in a digital environment there is the drawback of de-personalizing the company-customer relationship (IF the strategy is not properly executed), but at the same time, there is more room for an objectively structured strategy which CAN be focused on specific, narrow market segments.

Besides enterprises which implement and manage Internet marketing strategies, new entrepreneurs also can have major positive outcomes from applying Internet marketing strategies to their business activities [9]. Certainly, in the modern business environment, start-ups often face strict regulations, thus starting the business online (online business models) may reduce initial costs, and increase the probability for survival on the market.

Advances in digital technology create a global disruption where enterprises have to focus on customers and customer feedback. Social media, geo-targeting, new payment methods and other technologies put pressure on

existing enterprises to adapt their business models. Without this adaptation, chances for achieving competitiveness are low, or virtually non-existent [10]. Therefore, enterprises have to focus not only on product development but also on satisfying customers, creating rapport with customers with the ultimate goal to obtain high levels of customer loyalty.

Now, in this modern, digital, marketing environment, where the majority of organizations have their Internet marketing strategies, a key activity arises, and that is customer satisfaction management.

Customer satisfaction management as an activity is a part of customer relationship management (CRM). Creating value for customers has an important role in customer satisfaction [11]. Further, customer satisfaction has a major role in customer loyalty development. In the management process of customer satisfaction, it is necessary to not only satisfy customers, but to also maintain long-term satisfaction which would hopefully turn into loyalty. This is crucial, as customer loyalty further affects future sales.

A successful business and adequate business performance heavily depends on the retention of customers which is further affected by customer satisfaction. Measuring and managing customer satisfaction is not a simple process and it includes constant gathering of data and information through surveys, focus groups, monitoring and analytics software [12].

When managing customer satisfaction, it was found that trust development and resolving and handling emerging conflicts have a large impact on customer satisfaction levels. Therefore managers should focus on effectively resolving issues in a timely manner, or more precisely, to regulate customer complaints [13]. Implementing an effective customer support system can solve a large array of logistical obstacles when addressing customer complaints.

Based on this literature analysis, it is evident that similarly to traditional marketing, in Internet marketing there is also a constant pressure on enterprises to create value for customers, to satisfy customers, and to keep them satisfied. In the next section a theoretical model on managing customer satisfaction is presented.

### III. MANAGING CUSTOMER SATISFACTION

After the literature review, it was found that for a successful Internet marketing strategy it is necessary to effectively manage customer satisfaction. As previously mentioned managing customer satisfaction enables a more stable long-term positioning on the market. Customer satisfaction can lead to higher customer retention and customer loyalty development. This can further positively affect business performance and long-term competitiveness on the market.

When managing customer satisfaction an important component is feedback data and feedback data analysis. The feedback contains raw data or information on customer experiences, needs, **satisfaction** and complaints. Also, it may include data on market share, competitors and other important marketing metrics. The data includes

information on customers' wishes, expectations and satisfaction is gathered through the feedback loop. The data analysis process can include statistical processing, modelling causal relations, detecting trends, and resolving customer complaints. Further, in the modern business environment where the globalization of markets affects the majority of enterprises, the concept of customer satisfaction management within Internet marketing strategies is proven to be more and more relevant. Internet marketing strategy or digital marketing strategy is generally broad and it may include one or several other activities, approaches and concepts (SEO, content marketing, e-mail marketing etc.).

When an enterprise develops an Internet marketing strategy and conducts various business activities. These activities directly or indirectly affect customers. Thorough data analysis is conducted and based on the results from the processed data, the enterprise can modify its activities in order to increase customer satisfaction. Further, Figure 1. shows a model for customer satisfaction management.

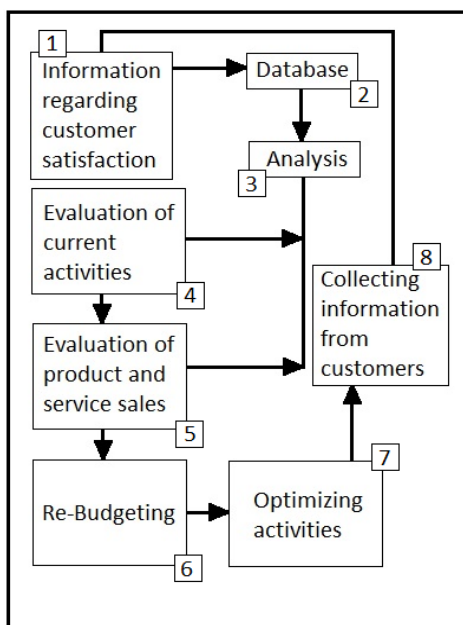

Figure 1. Customer satisfaction management dynamics

This model includes a block-scheme of interconnected elements/modules.

The elements of the depicted model on Figure 1. are:

- 1) Information on customer satisfaction - this information is obtained through the feedback loop, and it is the crucial part of the model.
- 2) Database - a place to store the acquired data from customers. From here the data is processed and analyzed.
- 3) Analysis - similarly to the main model, here the analysis is conducted on the data which is stored in the database.
- 4) Evaluation of activities - information and data is not only collected from customers, but also on the current business activities. This way a

comparative analysis can be conducted in order to determine the best course of actions for increasing customer satisfaction.

- 5) Evaluation of sales - besides the evaluation of customers and business activities, sales as an important metric is also analyzed.
- 6) Re-budgeting - optimizing costs and redefining main activities which would increase customer satisfaction. Resources can be rearranged to meet customer expectations and to help solve customer complaints faster.
- 7) Optimizing activities - the end result of one of the cycles of data analysis. Through optimization managers aim to lower operating costs, increase productivity and to effectively manage customers and their needs, with end results being higher customer satisfaction.
- 8) Collecting information - the beginning of a new cycle where new data is collected and analyzed in order to optimize business activities.

The model for managing customer satisfaction delves in the dynamic between some elements of business which directly or indirectly affect customer satisfaction. The collected information from customers is stored in a database. From here, the data is processed and analyzed. In addition, business activities and sales reports are also examined. Re-budgeting and optimization of business activities is conducted in order to lower costs, increase productivity and quality and finally increase customer satisfaction.

#### IV. GUIDELINES AND PROPOSITIONS

After analyzing the existing body of literature in the domain of Internet marketing and customer satisfaction, the following guidelines and propositions for effectively managing customer satisfaction are given:

- Creating value for customers should be a primary goal;
- Product quality should be high, but it is necessary to avoid over-investing in product quality, if lower quality materials are sufficient;
- It is important to engage with customers on social media;
- Customer complaints need to be addressed as soon as possible;
- Implementing software solutions for specific business activities can save time and money in the long-term;
- Customer satisfaction should be measured periodically;
- Products and services should contain additional value elements (memberships, online support etc.);

- Optimizing business activities will not only reduce costs but also increase productivity and with less effort better results will be achieved. This will further result in better products and higher customer satisfaction.
- Acquired loyalty should be maintained at all costs. The modern market is fierce with competition. Therefore, it is necessary to obtain and keep as many loyal customers as possible.

It is evident that the main points in these propositions are value, developing relationships, solving issues and optimization. Overall, the modern market is constantly changing, and if an enterprise wants to be or stay competitive, it too, has to constantly change. These changes should be based on analyzed data obtained from customers, as customer-centric business models are adequate for Internet marketing strategies. The globalization of markets pushes enterprises into a tough position, where high quality content, products and services have to be distributed in a timely manner with the goal to periodically satisfy customer needs and expectations which can further positively affect business performance and long-term competitiveness

#### V. CONCLUSION

Managing customer satisfaction is a crucial business activity which has to be conducted effectively and adequately. Within an Internet marketing strategy, customer satisfaction has to be managed in an almost instantaneous real-time fashion. The rapid distribution of information requires this, as negative customer experience can severely affect business performance. The customer management process depends on the type of activity conducted within the Internet marketing strategy. Thus, managers have to be prepared and to diligently analyze customer feedback.

The main limitation of this article is the lack of surveyed data on Internet marketing campaigns. However, this type of survey wouldn't provide sufficient insight in any case, thus the limitation is not severe. Now, what could have been done is that managers could be surveyed on how they manage customer satisfaction and customer experiences overall. For future research it is recommended that a structured meta-analysis should be conducted in order to summarize the results of customer satisfaction management in the domain of Internet marketing. This would significantly contribute to the existing body of literature, while this current article is an adequate starting point for this future research.

#### REFERENCES

- [1] A. Dilham, F.R. Sofiyah, and I. Muda, "The internet marketing effect on the customer loyalty level with brand awareness as intervening variables," *Int. J. of Civ. Eng. and Tech.*, vol. 9, no. 9, pp.681-695, 2018.
- [2] S. Kamboj, and Z. Rahman, "Marketing capabilities and firm performance: literature review and future research agenda," *Int. J. of Produc. and Perf. Man.*, vol. 64, no. 8, pp. 1041–1067, 2015.
- [3] U. Ramanathan, N. Subramanian, and G. Parrott, G. "Role of social media in retail network operations and marketing to enhance customer satisfaction," *Int. J. of Op. & Produc. Man.*, vol. 37, no. 1, pp. 105–123, 2017.
- [4] J. Loonam, S. Eaves, V. Kumar, and G. Parry, G. "Towards digital transformation: Lessons learned from traditional organizations," *Strat. Chan.*, vol. 27, no. 2, pp. 101–109, 2018.
- [5] J. Seitz, and A. Burosch, "Digital Value Creation," *IEEE Int. Conf. on Eng. Tech. and Inno. (ICE/ITMC)*, 2018.
- [6] H. Shaughnessy, "Creating digital transformation: strategies and steps," *Strat. & Leader.*, vol. 46, no. 2, pp. 19–25, 2018.
- [7] A. Lewnes, and K.L. Keller, "10 Principles of Modern Marketing," *MIT Sloan Man. Rev.*, vol. 60, no. 3, pp.1-10, 2019.
- [8] A. Yeow, C. Soh, and R. Hansen, "Aligning with new digital strategy: A dynamic capabilities approach," *The J. of Strat. Info. Sys.*, vol. 27, no. 1, pp. 43–58. 2018.
- [9] Y. Maher, "Entrepreneurship in digital marketing industry" BRAC University, 2018.
- [10] R.N. Bolton, R.G. Chapman, and A.J. Mills, "Harnessing Digital Disruption With Marketing Simulations," *J. of Market., Edu.*, vol. 027347531880341, 2018.
- [11] R. Rahimi, and M. Kozak, "Impact of Customer Relationship Management on Customer Satisfaction: The Case of a Budget Hotel Chain," *J. of Trav. & Tour. Market.*, vol. 34, no. 1, pp. 40–51, 2016.
- [12] I. Fečíková, "An index method for measurement of customer satisfaction," *The TQM Mag.*, vol. 16, no. 1, pp. 57–66, 2004.
- [13] M.A. Mahmoud, R.E. Hinson, and M.K. Adika, M. K. "The Effect of Trust, Commitment, and Conflict Handling on Customer Retention: The Mediating Role of Customer Satisfaction," *J. of Relation. Market.*, pp. 1–20, 2018.

# Developing Effective Internet Marketing Campaigns

M. Bakator and D. Radosav

University of Novi Sad, Technical Faculty "Mihajlo Pupin", Đure Đakovića bb, 23000, Zrenjanin, Republic of Serbia  
mihalj.bakator@uns.ac.rs; dradosav@tfzr.rs

**Abstract** - Internet marketing campaigns are the cornerstone of long-term business growth. Enterprises that don't have well-constructed, or simply don't have an online presence through an Internet marketing campaign are prone to poor business results. In this paper a theoretical model is presented on how an effective Internet marketing campaign is developed. The goal of the paper is to briefly review the literature in the domain of Internet marketing and to provide a concise model which depicts the key elements of developing effective online campaigns. In addition, guidelines on determining the most effective online activities are given. Further, the concise nature of the paper establishes key insights not only for fellow scholars, but for non-expert readers as well. Overall, the paper provides a solid basis for future research in this domain.

## I. INTRODUCTION

Internet marketing campaigns can be viewed as structured and organized activities through which an enterprise connects with existing and potential customers with the goal to exchange goods. Internet marketing campaigns are customer centric in nature and generally belong to the inbound marketing approach. This includes newsletters, videos, podcasts, eBooks, social media, SEO and other [1]. Internet marketing or digital marketing created trends where enterprises move from passive advertising campaigns to actively engaging with consumers and customers. In addition, social media has an important part in developing effective Internet marketing campaigns [2]. Based on this, it can be proposed that in the process of developing effective Internet marketing campaigns, it is necessary to address the potential of social media marketing as a major sub-strategy within the main strategy. This indicates that for an enterprise a social media presence becomes a necessity for achieving good business performance.

Further, through Internet marketing campaigns relationships with customers are developed. The interactions between the enterprise and customer is important to build strong relationships and loyalty which will further result in with good business performance. With growing relationships, customers' value also grows. The enterprise has to deliver value through the marketing campaign [3]. In the modern business environment, enterprises can apply artificial intelligence in their Internet marketing campaigns. Artificial intelligence has the ability to generate significant and useful results from obtained feedback data [4]. More detail on how an effective Internet marketing campaign could be developed is presented later on in the paper.

Overall, in this paper Internet marketing campaigns are analyzed. More precisely, the development process of an effective Internet marketing strategy is examined. The main goal of the research was to develop a theoretical model which explains the main elements and dynamics in the process of developing an effective Internet marketing campaign. The whole paper is structured in three main sections (excluding the introduction and conclusion sections). The first section briefly reviews the literature on Internet marketing and Internet marketing campaign management. The second section depicts a theoretical model on developing an effective Internet marketing campaign. The third section discusses guidelines for enterprises and managers for effective Internet marketing campaign development. After the three main sections, conclusions are drawn and future research is proposed.

## II. MANAGING A SUCCESSFUL INTERNET MARKETING CAMPAIGN

Managing a successful Internet marketing campaign must include a presence on one or more social media platforms. It was noted that a decision on product or service purchase is affected by recommendation from other users, opinions of influencers (users with high follower count), suggestions and requests from other users, and product quality [5]. Based on this, it can be seen that influencers on social media platforms represent a distribution channel for sharing information which may directly affect customers' purchase decisions. Therefore, implementing a social media marketing strategy along with collaboration with influencers can have a very positive effect on sale conversions.

For an enterprise it is important to know which social media platform is the most suitable for a specific product or service. Social media platforms allow narrow targeting potential customers, and existing customers, and the use of social media in a marketing strategy is a standard in the modern business environment [6]. Geo-targeting options are becoming more and more advance. In addition, targeting potential customers with specific interests has made the development of focused marketing campaigns a reality. This way costs are cut, and the reached consumer-to-customer yield is much narrower.

Furthermore, an important aspect of developing and managing a successful Internet marketing campaign is marketing analytics. Enterprises obtain feedback data from the customers, and what they do with this data is crucial for successfully managing the marketing campaign. Through gathering data, enterprises can

creatively build activities and strategies which will bring in new customers [7]. Developing Internet marketing campaigns requires sufficient data on the market segment, on the potential customers, and information about the available technological solutions which may be used for a specific campaign. Processing feedback data may give information on customer experience and expectations, market share and other metrics which can be used for optimizing marketing activities.

The importance of marketing analytics is evident from the start of every Internet marketing campaign. Analytical reports provide significant insight into important market parameters. Enterprises can modify and optimize their marketing activities in accordance with the processed data [9]. It is evident that a successful Internet marketing campaign has to be based on thorough feedback data analysis. The online nature of these marketing campaigns makes it easier to collect data from the market (customers, consumers, market share, competitors).

When managing a marketing campaign, be it online or not, the concept of integrated marketing communications is inevitable as it presents a strategy and approach which includes several promotional activities and tools which are essential for adequate business development and performance [8]. Similarly to traditional marketing, promotional activities are an important element of a successful Internet marketing campaign. Engaging customers with interactive promotional activities is a possibility with online campaigns, interactivity is harder to scale in traditional marketing approaches.

An effective promotion tool in marketing strategies is marketer-generated content. However, user-generated content has been found to be more effective when it comes to attitudes towards brands. It was also noted that user-generated content has a more positive effect on purchase intentions compared to marketer-generated content [10]. This indicates that “seeding” content can require less effort from the enterprise. This type content can afterwards “evolve” and be part of user-generated content. Therefore, enterprises should address the type of content they distribute, and aim at achieving viral spreading of that particular content.

Furthermore, when it comes to managing marketing campaigns online, enterprises have a large variety of software solutions for marketing automation. These pragmatic tools can support the development and execution phases of a marketing strategy [11]. Depending on what products or services are distributed on the market, the adequate software tool is applied. What is important that these tools can reduce operating costs, and reduce decision-making time.

Now, an important element and metric in any marketing campaign is creating and distributing customer value. Customer value is the cornerstone of brand loyalty, and on the Internet electronic word-of-mouth (eWOM) has a positive effect on purchase intentions and decisions [12]. Creating value for customers is a complex process which is heavily based on market research. Here, feedback data can provide support in the value creation process. It is important to create long-term value, meaning that the

product and or service should induce positive emotions and experiences in their exploitation process.

Based on these findings, it is evident that developing an effective Internet marketing campaign is relatively complex, and many factors can affect the development and execution process. In the next section a theoretical model of how to effectively develop an Internet marketing campaign is presented.

### III. EFFECTIVE CAMPAIGN DEVELOPMENT MODEL

After reviewing the literature in the domain of Internet marketing campaigns, a theoretical model is develop in order to concisely and visually demonstrate the development dynamics of an effective Internet marketing campaign. The model is presented on Figure 1.

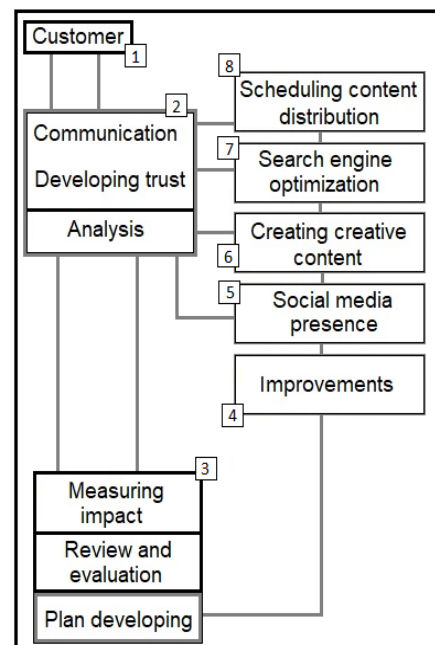

Figure 1. Developing an effective Internet marketing campaign - a theoretical model

The theoretical model includes several modules/elements which represent specific entities, actions or relations. The numbered elements in the model are the following:

- 1) Customer - when developing a marketing campaign, the needs and expectations of customers have to be met, in order to increase customer retention. The goal is to increase the frequency of events where the customer satisfaction was achieved. This approach has the potential to develop long-term loyalty.
- 2) Communication, developing trust and analysis. Through the communication process, the goal is to develop trust and loyalty with customers which will positively affect future purchase decisions. Analyzing these metrics is crucial in the development process. Communicating meaningful and high quality information can increase the interest in a certain product in the purchase decision making process of the consumer.

- 3) Measuring impact, review and evaluation and plan development - After analysis, the collected data is processed with the goal to determine the positive or negative impact of a product or service within the marketing campaign. Thorough review and evaluation is conducted and the basis for plan development is established. Reporting on market shares, and customer satisfaction, and consumer behavior play an important role in developing in developing long-term competitiveness on the market.
- 4) Improvements - based on the evaluated data, improvements are defined and planned in order to increase the effectiveness of the marketing campaign. Improvements depend on the observed situation on the market. Every action towards increasing business performance and the effectiveness of a marketing campaign has to serve the main defined goal of the enterprise. Thus, it is necessary to strategically plan out every improvement activity.
- 5) Social media presence - increasing the influence on social media sites helps in the expansion process to new markets. Social media allows hyper-distribution of information to a large user base. Therefore, it can help increase the awareness of consumers that a certain company and its products and services exist.
- 6) Creating creative content - creative and high quality content attracts the attention of consumers and increases the customer retention. Through content, the enterprise communicates why is a certain product or service the best option for a consumer to purchase. Content marketing is an inevitable part of an Internet marketing campaign. Without it, the message which is distributed by enterprise can easily get lost among the vast majority of other information.
- 7) Search engine optimization (SEO) - it is an important tool/method for increasing the visibility of a product or service. An effective SEO is an imperative for effective Internet marketing campaigns.
- 8) Scheduling content distribution - Creative and quality content is important. However, it is also necessary to address the timing of release or distribution of this content. Without a defined schedule, the impact of a distributed content can be severely handicapped.

The theoretical model depicts a concise overview of how an effective marketing campaign should be developed. The feedback of information or the analysis and impact measurement is the main part of the model, as through the feedback data adequate modifications and optimizations can be conducted which further result in with an effective marketing campaign.

Based on the model it can be proposed that without feedback from customers there is little to be done regarding developing and improving an existing

marketing campaign. Here, the main analysis and the corresponding evaluation of markets and customers are the basis for determining the best metrics in developing an effective campaign.

#### IV. GUIDELINES AND PROPOSITIONS

Based on the conducted literature review and the developed model, the following guidelines and propositions for managers and enterprises regarding effective Internet marketing campaign development:

- Enterprises have to identify their target market and focus on specific, narrow marketing activities. This will help in reducing costs.
- Adequate infrastructure for feedback data gathering should be established.
- Search engine optimization is an imperative for successful Internet marketing
- It is important to distribute high quality and creative content. Even more important is to develop a schedule based on which the content is distributed.
- The application of various software solutions are beneficial in making fast-paced decisions;
- It is advised that long-term strategies are flexible if changes occur on the market.
- Budgeting should be done by priority. Higher-priority activities should be fully funded, while lower priority activities should be optimized.
- When budgeting, the main goal of the business has to be taken in consideration. This will reduce overspending and spending on unnecessary activities.
- Duration of marketing campaign activities should be defined in accordance with the budget. Undercutting long-term activities due to resource shortage is less adequate compared to fully funding a short-term activity.
- Customers' satisfaction and experience should be periodically measured.

It can be proposed that the main component of Internet marketing campaigns is effective action to reaction. Or better say, an effective approach to resolving issues which are noticed through the analysis of feedback data.

#### V. CONCLUSION

In the development process of an effective Internet marketing campaign, it is necessary to integrate all the data and information obtained as feedback data. Managers and enterprises overall, have to be aware, that an adequate Internet presence, or more precisely, conducting business with effective Internet marketing campaigns, is an imperative for business success on the international

market. Obtaining feedback from customers, and effectively analyzing it, is the core of the Internet marketing campaign development process. What is even more important is to effectively and adequately process this feedback data, in order to make effective business decisions.

The main limitation of this paper could be also viewed as its strength, and that is its concise nature. By being concise, it lacks depth that would provide more detail in certain segments. However, this way the paper is more open to future research and provides a solid basis for further investigation. It is recommended that for additional studies, a structured survey should be designed and Internet marketing campaign managers should be surveyed. This way, a more in-depth view on Internet marketing campaign dynamics can be obtained. In addition, specific Internet marketing campaigns should be investigated. Overall, the conducted study contributes to the existing body of literature and it can be of value for the readers.

#### REFERENCES

- [1] R.D. Todor, "Blending traditional and digital marketing," *Bull. of the Transilvania Uni. of Brasov, Econ. Sci. Ser. V*, vol. 9, no. 1, pp. 51-56, 2016.
- [2] M. Pinaki, and N. Joshi. "Understanding Digital Marketing Strategy," *Int. J. of Sci. Res. and Man.*, vol. 5, no. 6, 2017.
- [3] A., Joshi, "Digital technologies for enhancing customer experience," *Sansmaran Res. J.* , pp.1-8, 2018.
- [4] P.K. Theodoridis, and D.C. Gkikas, "How Artificial Intelligence Affects Digital Marketing," *Springer Proceed. in Bus. and Econ.*, pp. 1319–1327, 2019.
- [5] A. Müller, "Referral Marketing on Social Media Platforms—Guidelines on How Businesses Can Identify and Successfully Integrate Opinion Leaders in Their Online Marketing Strategy," *Omnichannel Brand.*, pp.131–171, 2018.
- [6] B. Madhu, and Mr D. Verma, "A Critical Review of Digital Marketing," *Int. J. of Man., IT & Eng.*, vol. 8, no. 10, 2018.
- [7] X. Liu, and A.C. Burns, "Designing a Marketing Analytics Course for the Digital Age," *Market. Edu. Rev.*, vol. 28, no. 1, pp. 28–40, 2018.
- [8] S.K. Rahman, "Influence of digital marketing: connecting customers digitally with Symphony Mobile." BRAC University, BRAC Business School, pp. 7-29, 2019.
- [9] M.A. Camilleri, M. A. "Integrated Marketing Communications," *Trav. Market., Tour. Econ. and the Airline Product*, pp. 85–103, 2017.
- [10] K. Cowan, and L. Hunt, "What Makes Digital Content Influential? A Comparison of Celebrities and Influencers: An Abstract," *Springer Oceanography*, pp. 541–541, 2019.
- [11] M.D. Vecchia, and M.K. Peter, "Marketing Automation," *Stud. in Sys., Dec. and Cont.*, pp. 117–130, 2018.
- [12] S. Ghai, and O. Rahman, "Measuring Effectiveness of Campaigns Using Digital Marketing & Its Impact on Youth," *Int. J. on Global Bus. Man.& Res.*, vol. 7, no. 3, pp.19-30, 2018.



# Quality Comparison of Various Machine Classification Techniques

S. S. Sosinskaya, M.V. Porokhova and I.S. Komarov  
Irkutsk National Research Technical University, Irkutsk, Russia  
sosinskaya@mail.ru, mariannaporohova@mail.ru, lifekomarov@gmail.com

**Abstract** - The article discusses the approach to classification of machines described by a set of numerical attributes according to their types based on decision trees and their ensembles, the fuzzy inference system and support vector machine method. Based on the information stored in database tables, a single table of attributes has been constructed for all the machine models. The classification results are analyzed with these methods, and the most efficient is recommended according to the conformity percentage. An expert system developed on the base of a fuzzy inference system for the same set of machines, allowing determining the type membership of the machine by answering the specific questions, is described. This expert system can be used on new machines not included in the predefined set. The software implementation is based on MATLAB system, which provides a variety of tools and methods for acquisition, analysis and visualization of data.

## I. INTRODUCTION

Intelligent data analysis is one of the most important areas of research in the modern world. In order to process large arrays of data, Data Mining is being used, in particular, for classification and clustering. Data classification comprises of defining rules and algorithms of their construction for the proper grouping of the sampled data. Each group (class, cluster) is characterized by certain features, which belong to all cluster components. The number of classes is provided in advance as a result of consideration of the conceptual framework of the subject.

Clustering data is the partitioning the sampled data on various groups so that components of the same group were similar according to a measuring technique of the distance between pairs of sample objects. During clustering, the number of groups is not set and determined within the program execution, in this case of classification the number of classes is provided in advance. In order to traverse the contents of large databases, it is necessary to spend a large amount of time. Therefore, it is advisable to implement a number of methods to automate routine operations of data classification.

The use of techniques of quality evaluation of the classification performance and analysis of results will allow us to make recommendations for the choice of the most effective method for further classification of newly acquired machines and develop an expert system for this purpose.

## II. MACHINE CLASSIFICATION

### A. Data preparation

For an intelligent data analysis, a database of machine tools from website [www.innovatics-tm.ru](http://www.innovatics-tm.ru) [15] has been

used. This database was chosen due to its large size (691 models, each of which is characterized by 185 attributes), but also because of the difficulty to find open access data associated with a specific company.

Each machine model in the database belongs to a particular group. There are nine groups of machines:

- Turning;
- Drilling and boring;
- Grinding, polishing, lapping;
- Combined;
- Gear and thread processing;
- Milling;
- Planning, slotting, broaching;
- Splitting;
- Center processing.

Common features for all groups are the following:

- The largest diameter of work piece, mm;
- The minimum rotation frequency;
- The maximum rotation frequency;
- The minimum engine power, kW;
- The maximum engine power, kW;
- The length of the work piece, mm;
- The length of the machine, mm;
- The width of the machine, mm;
- The height of the machine, mm;
- The machine weight, kg.

In addition, each type of machine has own specific set of features. For example, machines of the turning group have the following characteristics:

- The maximum number of tools;
- The diameter of the faceplate/spindle, mm;
- The weight of the work piece set;
- The flow, rotations, min;



For the problem at hand, the construction of an ensemble of type bagging were carried out. The classification results of all used techniques are discussed in section III.

#### D. Fuzzy inference system

Fuzzy inference system is a method of obtaining the output data about the object (for example, belonging to a specific class) based on the input data, which describe the information about the state of the object.

Let  $MF_c(x)$  be the degree of membership of  $x$  to fuzzy set  $C$ , which defines a generalization of the concept of the characteristic function of crisp (ordinary) sets. A set  $y$  of ordered pairs is called a fuzzy set, denoted by the letter  $C$  as in formula (2).

$$C = \{MF_c(x), x\}, MF_c(x) \in [0,1]. \quad (2)$$

The membership function equal to zero means the object does not belong to a class, its equality to one indicates full membership to the class.

In the article, triangular functions are used for a term membership expression. A triangular function has three parameters  $a, b, c$ , and its value a calculated according as in formula (3).

$$MF(x) = \begin{cases} 1 - \frac{b-x}{x-a}, & a \leq x \leq b, \\ 1 - \frac{x-b}{c-b}, & b \leq x \leq c, \\ 0, & x \in (a, c). \end{cases} \quad (3)$$

For descriptions of fuzzy sets, linguistic (fuzzy) variables and their terms are used. In order to determine the correspondence between the numerical value of the input variable of the fuzzy inference system and the corresponding value of the membership function for a term of linguistic variable a concept of fuzzification is introduced. It is a procedure of figuring out the values of the membership functions of fuzzy sets (terms) based on crisp input data.

For the implementation of fuzzy inference, a database of rules is used, which is built out of terms of input and output variables; each rule has the following form:

IF a premise THEN a conclusion

In this case, the premise is a combination of terms of the input variables and conclusion is a term of the output variable. As the problem of classification is being solved, a knowledge base of type Sugeno is constructed, rule conclusions  $d_i$  are represented with linear functions of the inputs by the formula (4).

$$d_i = b_{j,0} + \sum_{i=1}^n b_{j,i} x_i \quad (4)$$

The article proposes an approach to build the system of fuzzy inference over a decision tree. It is assumed that each branch of the tree from root to leaf is a rule. A test condition for an input variable is its node with a corresponding value. The fuzzy inference system includes only those input variables, which are referenced in the tree, and one output variable with the terms, corresponding to the leaves of the tree, i.e., the values of the classification attribute.

Input and output variables of the system of fuzzy inference constructed according to a decision tree is presented in Fig.2.

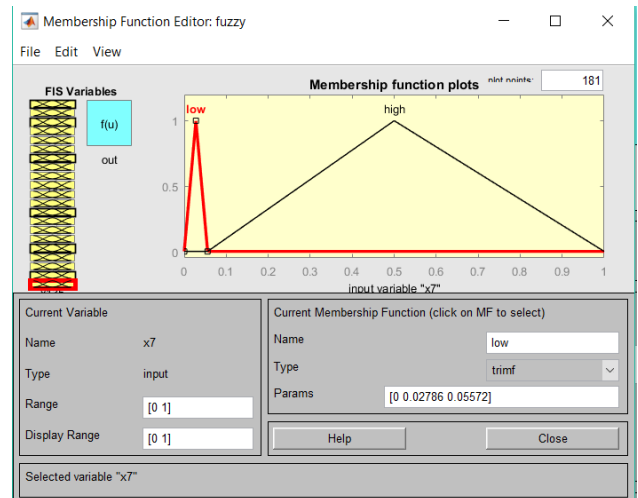

Figure 2. Input and output variables of a system of s fuzzy inference

A part of the rule set for this system is showed in Fig. 3.

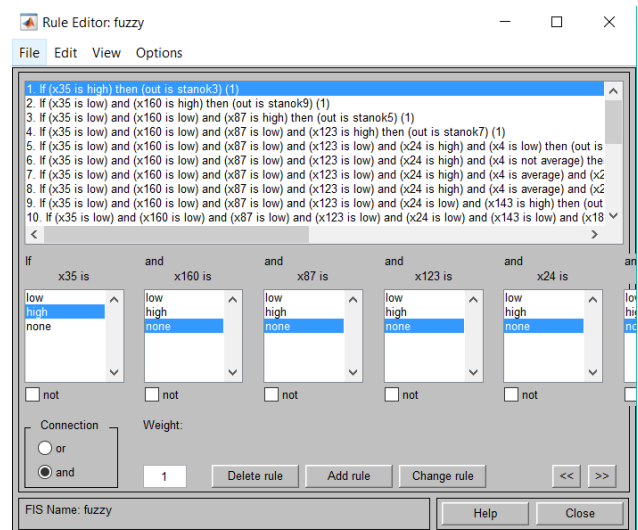

Figure 3. A fragment of the rule set

#### E. Support vector machines

The support vector machine (SVM) belongs to the group of boundary methods. Classes are defined using the borders of regions. This method initially is referred to binary classifiers, although there are techniques of implementing the method for problems of division of objects into several classes. The method is based on the concept of solution planes.

The support vector machine builds a classifier function, which is defined as in formula (4).

$$F(x) = \text{sign}((w, x) + b), \quad (4)$$

where  $(\cdot)$  is the scalar product,  $w$  is a normal vector to the separating hyperplane,  $b$  is an auxiliary parameter. Thus, the objects for which  $F(x) = 1$  are in one class, and objects with  $F(x) = -1$  are in the other. The choice of such function is not accidental: any hyperplane can be set in formula (5).

$$(w, x) + b = 0. \quad (5)$$

For some  $w$  and  $b$  split variants are shown in (Fig.4).

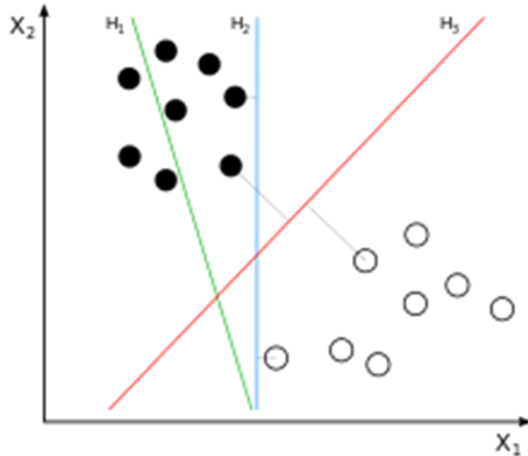

Figure 4. An illustration of SVM for two classes

In the case of multiple classes, the algorithm represents the problem of classification as problem of multiple split into two subclasses. A general approach for such transition includes stage of a construction of binary classifiers which distinguish between

- one class from the rest (one-versus-all),
- one class from the other (one-against-one).

Classification of new objects using one-against-all is done by the "winner takes it all" strategy. Classifier having the highest value of the output function assigns the new object to a class. In the Fig. 5, the classification results of training and testing samples for an array of machines is shown.

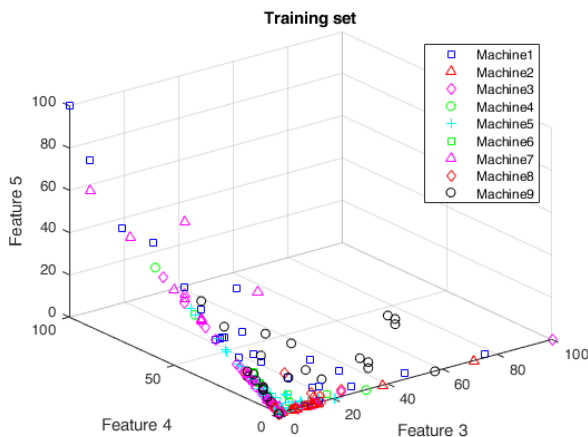

Figure 5. A visualization of classification results for the training samples of machines

#### F. Expert system for the machine type determination

The designed GUI application shows the questions for each input variable of the fuzzy inference system, and accepts answer choices, which are terms of the input variables. By choosing answer terms, the user will receive the decision about the group for a machine corresponding to a chosen set of the values of the input variables. The GUI window of the expert system is shown in Fig. 6.

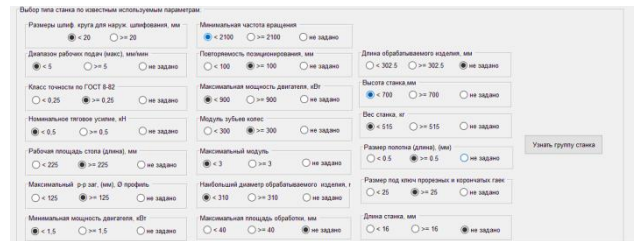

Figure 7. A GUI window of the expert system

#### G. Reduction of the dimension of the feature space of the original sampling

There are a large number of features in the original machine sampling. This may be a problem of overfitting, which arises when big volumes of feature data at some point do not improve but worsen the results. In such cases, a data reduction can be applied, *i.e.*, decreasing the number of dimensions of the feature space without significant loss of information. There are a number of methods for this purpose. This study uses the principal component analysis (PCA). Calculation of the principal components can be represented as a calculation eigenvectors and eigenvalues of the covariance matrix for source data.

A principal component replaces the original matrix of observations with the product of two matrices: matrix of loads and matrix of scores. Matrix of scores is a projection of the original observations to the space of principal components. The order of the rows in these matrices corresponds to the descending a percentage of the total variance explained by each principal component. Instead of the original matrix of observations, we will use new one, the matrix of scores, performing the classification of the previously discussed techniques for its first 10 columns. In Fig. 7 results are visualized for a reduced training samples of array machines with support vector machine.

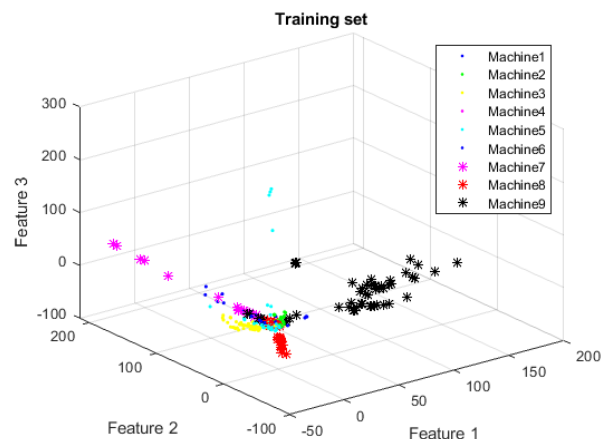

Figure 7. A visualization of classification results for the reduced training samples of machines

### III. COMPARISON OF QUALITY USED CLASSIFICATION METHODS

To assess the quality of classification for the testing and training samples, we built a matrix of qualities comparing the number of correctly classified objects for each technique with a known number of objects of each class and looked for the average percentage of matches for each of the

samples. The results of the comparison are presented in Table 1.

TABLE 1. THE RESULTS OF DIFFERENT CLASSIFICATION TECHNIQUES

Sampling	Decision tree		Ensembles (Bagging)		Support vector machine	
	% of matches	Run time	% of matches	Run time	% of matches	Run time
<b>Training</b>	83.7	0.816	99.66	2.479	99.34	6.381
<b>Testing</b>	83.7		99.66		99.34	

Analyzing this table, we see that the percentage of matches of training and testing samples for all techniques is the same. This is because each sample included half of the objects of each class.

The percentage of matches for decision tree is the lowest; ensembles of decision trees give a much higher percentage of matches. The support vector machine produces almost the same percentage of matches. However, the runtime of the decision tree is the lowest. Thus, for new machine classification, user can choose by considering the importance of factors of training time or classification quality. However, all three considered methods produce a high percentage of matches. Methods of fuzzy inference and boosting ensemble, which gave significantly worse results, have not been compared. Classification results for a reduced feature set are shown in Table 2.

TABLE 2. THE RESULTS OF VARIOUS CLASSIFICATION METHODS ON THE REDUCED SAMPLE SET

Decision Tree, % of matches	Ensembles (bagging), % of matches	Ensembles (boosting), % of matches	Support vector machine, % of matches
<b>87.3</b>	<b>100</b>	<b>77.3</b>	<b>96.1</b>

Analyzing this table, we see that the percentage of matches in the decision tree method is not changed; the same is for bagging ensemble, whose percentage is not changed too. For the support vectors machine, the percentage is slightly reduced. However, for the boosting ensemble, which previously had a very low percentage of matches, in this case, it turned out to be much better due to the disappearance of the overfitting effect.

#### IV. CONCLUSION

Authors recommend all three methods to be used for classification of new machines and consider that the reduction of feature set is productive. Obviously, an additional research using a variety of reduction and selection methods should be carried on, selecting the most informative features.

#### REFERENCES

- [1] Allwein, E., R. Schapire, and Y. Singer. "Reducing multiclass to binary: A unifying approach for margin classifiers." *Journal of Machine Learning Research*. Vol. 1, 2000, pp. 113–141.
- [2] Fürnkranz, Johannes, "Round Robin Classification." *J. Mach. Learn. Res.*, Vol. 2, 2002, pp. 721–747.
- [3] Escalera, S., O. Pujol, and P. Radeva. "On the decoding process in ternary error-correcting output codes." *IEEE Transactions on Pattern Analysis and Machine Intelligence*. Vol. 32, Issue 7, 2010, pp. 120–134.
- [4] Loh, W.Y. "Regression Trees with Unbiased Variable Selection and Interaction Detection." *Statistica Sinica*, Vol. 12, 2002, pp. 361–386.
- [5] Breiman, L. "Random Forests." *Machine Learning*. Vol. 45, pp. 5–32, 2001.
- [6] Freund, Y. "A more robust boosting algorithm." *arXiv:0905.2138v1*, 2009.
- [7] Friedman, J. "Greedy function approximation: A gradient boosting machine." *Annals of Statistics*, Vol. 29, No. 5, pp. 1189–1232, 2001.
- [8] Friedman, J., T. Hastie, and R. Tibshirani. "Additive logistic regression: A statistical view of boosting." *Annals of Statistics*, Vol. 28, No. 2, pp. 337–407, 2000.
- [9] Hastie, T., R. Tibshirani, and J. Friedman. "The Elements of Statistical Learning", Springer, New York, 2008.
- [10] Seiffert, C., T. Khoshgoftaar, J. Hulse, and A. Napolitano. "RUSBoost: Improving classification performance when training data is skewed." *19th International Conference on Pattern Recognition*, pp. 1–4, 2008.
- [11] Warmuth, M., J. Liao, and G. Ratsch. "Totally corrective boosting algorithms that maximize the margin." *Proc. 23rd Int'l. Conf. on Machine Learning, ACM*, New York, pp. 1001–1008, 2006.
- [12] Breiman, L. "Random Forests", *Machine Learning 45*, pp. 5–32, 2001.
- [13] Christianini, N., and J. C. Shawe-Taylor. "An Introduction to Support Vector Machines and Other Kernel-Based Learning Methods", Cambridge, UK: Cambridge University Press, 2000.
- [14] Hastie, T., R. Tibshirani, and J. Friedman. "The Elements of Statistical Learning", Second Edition. NY: Springer, 2008.
- [15] Innovation. Educational-methodical complex for modular, network, electronic and distance education, training of designers, technologists and organizers of innovative design in machine and instrument engineering URL: <http://www.innovatics-tm.ru>

# Online Service for Modeling Forest Dynamics on the Geoportal

A.K. Popova

Matrosov Institute for System Dynamics and Control Theory, Siberian Branch of Russian Academy of Sciences,  
Lermontov st. 134, Irkutsk, Russia  
chudnenko@icc.ru

**Abstract** - The article considers an online service designed to simulate the dynamics of forest resources. The mathematical model used takes into account the impact on forests of anthropogenic and adverse natural factors. Verification was carried out for the model by comparing the observed and calculated data, which showed that the model is acceptably accurate. For calculations, the user creates possible scenarios for the development of forest resources by changing the initial data - the volumes of the impact of factors. The calculation results are displayed on the map, where the forestry areas are colored in accordance with the calculated result. In conclusion, an assessment of the developed online service is given, ways of further development are analyzed, which will help to obtain more accurate results.

## I. INTRODUCTION

To assess changes in forest resources over time, mathematical models are used to describe their dynamics [1, 2, 4]. Such an assessment is a tool to study the dependencies of the development of the resource and to predict the results of the impact of various factors.

A comprehensive description of the state of the forest should include the parameters of natural dynamics and human impact. Then, combinations of initial parameters form a resource dynamics scenario that reflects the effects of factors. A set of various scenarios forms information for decision support for choosing a management strategy that combining economic efficiency in the operation of the forest with maintaining the ecological environment.

The implementation of the modeling system in the form of a web service simplifies the use of the created algorithm. The service does not require installation of additional software and is available to users through a standard browser.

## II. MATERIALS AND METHODS

### A. Mathematical model

In this work I use the model "Dynamics of stands". It's based on the works of A.K. Cherkashin [6-7], taking into account the studies of Shifley, He [1], Shugart [3, 5], Jönsson [2], Bugmann [4]. This is a model of a

subregional class that considers the dynamics of forests of different age categories in areas of the size of forestry.

The dynamics is described by a system of differential equations. Land areas of different types are made on the modeled territory: non-forested, uncovered by forest, young, middle-aged, maturing, mature and over-mature. Non-forest area is an area where forests cannot grow. It includes settlement, road, and deposit areas. The surface of non-forested areas is not covered by trees temporarily. It's an area after the fire, cutting, damage by insects and weather conditions. The dynamics of each section is described by formulas as follows in eq. 1:

$$\begin{aligned} \frac{dS_N}{dt} &= -a_{N0}S_N(t) + u_{non\ N}(t), \\ \frac{dS_0}{dt} &= a_{N0}S_N(t) - a_{01}S_0(t) + u_{ncov\ 0}(t) + u_{cut\ 0}(t) - u_{non\ 0}(t), \\ \frac{dS_i}{dt} &= a_{i-1i}S_{i-1}(t) - a_{i\ i+1}S_i(t) - u_{non\ i}(t) - u_{ncov\ i}(t) - u_{cut\ i}(t), \end{aligned} \quad (1)$$

where  $a_{ij}$  are the coefficients of transition from one category of land or age group to the next;

$S_N$  is the non-forest area;

$S_0$  is an area that is uncovered by forest;

$S_i$  is forest areas of different classes of age;

$u_{non\ i}$  is annual increase in non-forest area at the expense of other categories of land;

$u_{ncov\ i}$  is increase in the area uncovered by forest;

$u_{cut\ i}$  is the area of cutting, is subtracted only from the category of mature and over-mature forests, in other classes of age cutting is not carried out.

The annual decrease of the volume of forest resources is due to the impact of natural adverse factors and anthropogenic use. Annually forests are exposed to a set of adverse factors. This study was carried out in Irkutsk region of the Russian Federation. The region is located in the center of Eurasia, in Eastern Siberia. The weakening and destruction of forest plantations in the Irkutsk region is affected by:

- fires;

- forest diseases;
- damage by insects;
- adverse weather conditions;
- other anthropogenic and non-pathogenic factors.

The fires (43.7%), forest diseases (25.2%) and insect damage (16.2%) are the most important factors for drying up and destruction of forest resources, so these factors should be taken into account in the model:

$$u_{ncov} = S_g + S_{nas} + S_b \quad (2)$$

The distribution of  $u_{ncov}$  by categories of land is assumed to be proportional to the current area of each region:

$$u_{ncov\ i} = u_{ncov} * \frac{S_i}{\sum_i S_i} \quad (3)$$

The pyrogenic factor is the main reason for the weakening of plantations and death of forests. The calculations take into account only the area of forest resources with the lost stability, not including all the lands passed by fires.

Damage by insects causes shrinking and weakening of trees, a decrease in growth, causing unsatisfactory condition of forest resources. The calculations also take into account only plantations with lost resistance, not including all disturbances.

Permitted anthropogenic use of forest resources in the Irkutsk region limited to the following list of activities:

- cutting;
- agriculture;
- recreational activity;
- development of mineral deposits, work on geological study of mineral resources;
- construction and operation of linear objects;
- building and operation of reservoirs and other hydraulic structures;
- processing of wood and other forest resources.

Harvesting of wood is carried out in operational forests. It includes clear and selective cutting of mature and overmature plantations, clear and selective sanitary cutting, care, and other cutting. The annual allowable cut for forestry in the Baikal region is 71.5 million m<sup>3</sup>. At the same time, the actual volumes of cutting allow us to reach the estimates only by 40%.

The area of forest areas used for cultural and recreational purposes is increasing for the development of tourism. Recreational activity is being carried on in the Baikal region with access to Lake Baikal, infrastructure and unique natural objects are being developed on its territory.

The exploitation areas of forests are involved in the mining and subsoil exploration, and a part of the reserve forests is transferred to operational ones. Construction and maintenance of hydraulic structures is carried out on the territory of that forestry, where modern wood processing enterprises are being created.

Therefore, the increase in non-forest area in the process of forest exploitation is as follows:

$$u_{non} = k_N VN + VS + VR + VG + VB_l + VB_v, \quad (4)$$

where  $k_N$  is the area of settlements per person, the remaining coefficients characterize the increase of forest population,  $\Delta N$ , agricultural area,  $\Delta S$ , recreational zones,  $\Delta R$ , area of fields,  $\Delta G$ , construction of linear objects,  $\Delta B_l$ , and maintenance of hydraulic structures,  $\Delta B_v$ .

The transition of other categories of land to non-forest ones is done at random, depending on the needs of production. On this basis, the distribution of  $u_{non}$  for the remaining categories of land considered to be similar to the previous one:

$$u_{non\ i} = u_{non} * \frac{S_i}{\sum_i S_i} \quad (5)$$

Summation is made for all breeds and classes of age, including uncovered forest areas.

#### B. Verification of the model

Verification of the adequacy of the model and coefficients of transition  $a_{ij}$  calculation is done on the base of forestry input data of Baikal region for 1973. Input includes natural dynamics – the distribution of forest areas by age categories, anthropogenic use and adverse factors – volumes of cuttings, fires and forest plantations on the territory of 53 forest districts. Computations for the model were conducted for an interval of 45 years. The final results of the simulation were compared with the available data on forest areas for 2017, obtained from the official «Forest Plan of the Irkutsk Region».

It was taken into account that in 2008 the Ust-Ordynsky Buryat Autonomous Area with the area of 22,138 thousand km<sup>2</sup> was united with the Baikal region. Forest districts placed on its territory were not included in the final results for 2017. The total areas of different age categories for all forestry were calculated for comparison.

Figure 1 shows a histogram comparing non-forested and forest areas by age classes, summarized by all forest districts of Irkutsk Region, in 1973, 2017 years and data obtained by calculations of the developed algorithm.

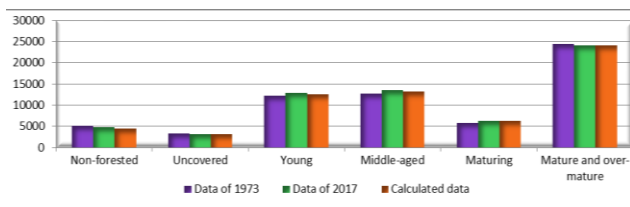

Figure 1. Chart of comparison of calculated and real data.

TABLE I. COMPARISON OF REAL AND CALCULATED DATA

Area type	Actual data, years		Simulation	Error, %
	1973-1985	2017		
Non-forested	5108,223	4670,194	4401,66	5,75
Uncovered	3273,893	3032,455	3166,37	4,42
Young	12161,067	12847,546	12044,61	6,25
Middle-aged	12648,814	13411,571	13137,08	2,05
Maturing	5783,593	6170,173	6215,15	0,73
Mature and overmature	24444,429	24128,406	23089,60	4,3
<b>Total</b>	<b>63420,02</b>	<b>64260,35</b>	<b>62054,47</b>	<b>3,43</b>

As can be seen from Table I, the dynamics of areas change of different categories according to real and calculated data is the same. Non-forest areas and covered with mature and over-mature forest plantations have slightly decreased; uncovered, the area of young, middle-aged and maturing are increased. The difference between statistical and forecast data is due to the lack of accurate information on fires and the volume of all cutting over a period of 45 years. Some areas of Baikal region are difficult to access or inaccessible, hence, a regular forest pathological examination is difficult there.

In the last column of Table I is the calculated relative error of the forecasting. The formula of the error is as follows:

$$E = \frac{|S_{calc} - S_{true}|}{S_{true}} * 100\% \quad (1)$$

where  $S_{calc}$  is simulation data,  $S_{true}$  is actual data.

The relative error should not exceed 10% for the model to be considered valid. In "Dynamics of stands" the average error was 3.43%, therefore this model can be used for predictive simulation and assessment of the trends of the general dynamics of forest resources under influence of various management decisions.

### III. RESULTS AND DISCUSSION

The online service was created for use on the portal of IDSTU SB RAS. The service is written in JavaScript, the open library Leaflet is used to display the map. The table with the initial data is uploaded by the user to the geoportal, the service receives the data through a JSON request. To form a scenario, it is necessary to specify the length of the calculation period in years, the volumes of felling, fires and economic impact. Next, the calculation algorithm begins using a mathematical model, which at the end gives the predicted value of the forest areas of each age class for all forestries.

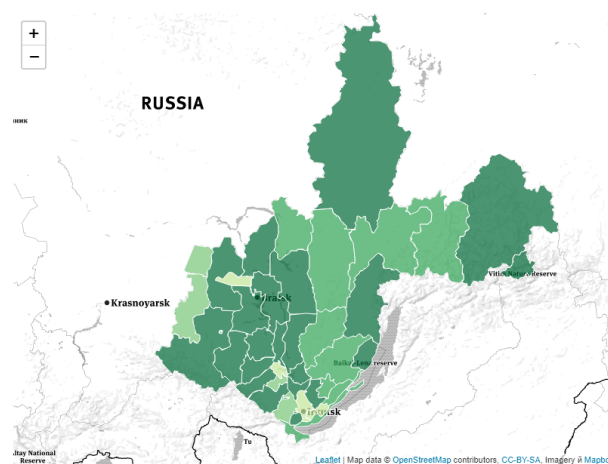

Figure 2. Resulted map in browser.

To build a visual map based on the calculation results, for each section of the territory its dynamics is calculated - the difference between the forest area in the last and first years of the modeling period. Then, the difference obtained is divided by the total forestry area to obtain relative values. According to these values, all forest areas are divided into four categories, each of which has its own color value. The service transfers the received information in the GeoJSON format to the geoportal, where the result map is displayed using the Leaflet.

For example, calculations were carried out for a period of 50 years, taking into account the preservation of the current volumes of logging, fires and other adverse factors. The simulation results are shown on the map of the Irkutsk region on fig.2. The difference between the forest area for all categories of age at the end and the beginning of the simulation interval was taken as a measure. In fig. 2, lighter shades correspond to negative values relative to the initial values, it is a decrease, darker shades is positive values, i.e. their area increases.

It can be seen that forest areas located in the central part of the region are most affected by anthropogenic influence. In large forest areas in the north and east of the region remain almost at the same level,



regardless of the scenario of their use. It is due to their low transport accessibility.

Six different scenarios were computed to estimate the dynamics of the forest resources of Irkutsk region for 50 year interval. Forecasts were based on the data for 2017 by categories of land and age classes of forest resources of all forestries in the territory of the Baikal region. Units of measure are total areas in thousand hectares in all forest districts.

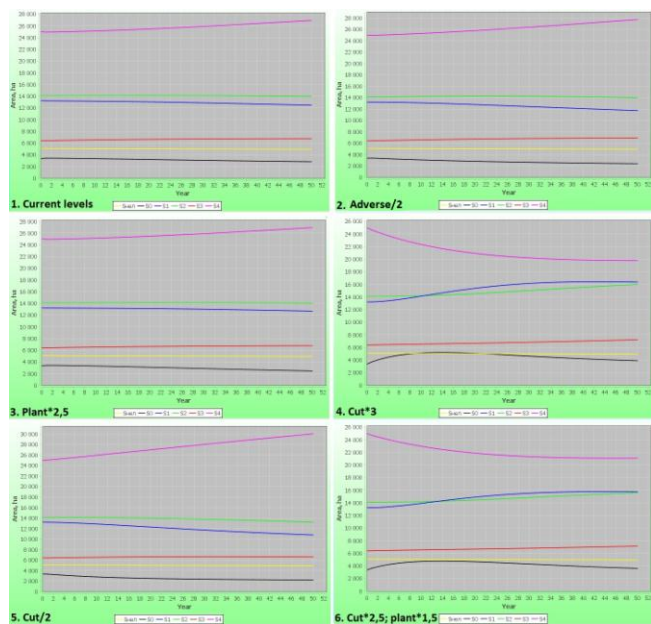

Figure 3. Six scenarios of dynamics of forest resources

The considered scenarios are:

1. Current levels of cutting, tree planting and the influence of adverse factors.
2. Reducing the influence of adverse factors by 2 times.
3. Increase in the volume of tree planting by 2.5 times.
4. Decrease of cuttings by 2 times.
5. Increase of cuttings by 3 times.
6. Increase cuttings by 2.5 times, planting by 1.5 times.

The results show that at the current levels of natural and anthropogenic impact in the long run the areas of mature and over-mature forests grow confidently with a slight decrease in young growth. In the second scenario, we observe a sharp increase in mature and over-mature forests with a slower decline in young growth and uncovered by forest land. The dynamics of forests in the third scenario is similar to the first one.

In the fourth scenario, there is a remarkable decrease in the level of mature and over-mature forests during the

first 30 years with an increase in the areas of younger age categories. No-covered areas increase for 15 years, then gradually begin to decline. In the fifth scenario, sharp growth of mature and over-mature forests was noted with a slight decrease in younger age categories. In the latter scenario, stocks of mature and over-mature declines over the first 35 years, then remain at the same level.

#### IV. CONCLUSIONS

The created web service helps to model the dynamics of forest resources, taking into account the impact of natural and anthropogenic factors. The calculation results are presented to the user in the form of tables and maps. Total values are displayed for each year from a given period for each land category and tree age class. With their help, you can most fully analyze the simulation results.

Before starting the calculations, the used model "Dynamics of stands" was verified. The calculated modeling data for a period of 45 years on the basis of available information on the forests of the Irkutsk region for 1973 were compared with real data for 2017. As a result, the accuracy of the model was 3.43%, with an allowable relative error of 10% - therefore, "Dynamics of stands" can be used to assess the consequences of managerial decisions for territories of rank forestry and the region.

The combination of mathematical modeling methods with the capabilities of geographic mapping provides for the integration of information flows in forestry activities, the visual display of information on the spatial and temporal state of forest resources. The results obtained are intended to support the adoption of regional decisions in the field of forestry management, contributing to the achievement of economic development and the preservation of an environment that is comfortable for humans.

At the same time, not all possible natural and anthropogenic factors affecting the change in the forest landscape were taken into account in scenario calculations. To obtain more accurate results, other factors must be taken into account - climate, harvesting, urban development plans. The calculations are also based on the assumption that the rates of transition from one category of land to another and the magnitude of the factors taken into account in the future will coincide with those currently available. Such assumptions reduce the accuracy of the results, making it possible to simplify the modeling process.

#### REFERENCES

- [1] Shifley S. R., He H. S., Lischke Y., Wang W. J., etc. The past and future of modeling forest dynamics: from growth and yield curves to forest landscape models. *Landscape Ecol.* 2017, 32:1307–1325.
- [2] Jönsson, A.M., Lagergren, F. & Smith, B.: Forest management facing climate change - an ecosystem model analysis of adaptation strategies. *Mitigation and Adaptation Strategies for Global Change* (2015) 20: 201. <https://doi.org/10.1007/s11027-013-9487-6>
- [3] Yan, H., Wang, S., Wang, J., Shugart H., et al.: Multi-model analysis of climate impacts on plant photosynthesis in China

- during 2000-2015. *International Journal of Climatology*. Volume 39, Issue 11, (2019). <https://doi.org/10.1002/joc.6170>
- [4] Schuler, L.J., Bugmann, H., Petter, G. et al.: How multiple and interacting disturbances shape tree diversity in European mountain landscapes. *Landscape Ecol* (2019) 34: 1279. <https://doi.org/10.1007/s10980-019-00838-3>.
- [5] Shugart H.H. *A Theory of forest dynamics. The ecological implications of forest succession models*. N.Y., Springer, 1984.
- [6] Cherkashin A.K. Forecasting the spatial and temporal dynamics of forests of taiga landscape. *Dynamics of Ecologo-Economic Systems*. Novosibirsk, Nauka, 1981, 107-111.
- [7] Cherkashin A.K. The model for the dynamics of forest stands of a district forestry and its use in solving prediction problems. *Planning and Forecasting of Natural-Economic Systems*. Novosibirsk, Nauka, 1984, 69–81.
- [8] Alonso-Betanzos, A., Fontenla-Romero, O., Guijarro-Berdiñas, B., Hernández-Pereira, E. et al.: An intelligent system for forest fire risk prediction and fire fighting management in Galicia. *Expert Syst. Appl.*, 25 (4), pp. 545-554 (2003).
- [9] Jaziri, W.: Using GIS and multicriteria decision aid to optimize the direction of trees cutting in the forest ecosystem: A case study. *Computers and Electronics in Agriculture*, vol 143, pp 177-184 (2017).
- [10] Singh, H., Garg, R.D., Karnatak, H.C.: Online image classification and analysis using OGC web processing service. *Earth Science Informatics* (2019). <https://doi.org/10.1007/s12145-019-00378-z>.
- [11] Castronova, A., Goodall, J., Elag, M.: Models as web services using the Open Geospatial Consortium (OGC) Web Processing Service (WPS) standard. *Environmental Modelling & Software*, vol. 41, pp 72-83 (2013).
- [12] OpenGIS® Web Processing Service (WPS) Standard, Version: 1.0.0 (2007).
- [13] OGC Web Processing Service, <https://www.opengeospatial.org/standards/wps>, last accessed 2019/08/28.
- [14] Popova A.K., Vladimirov I.N. Multilevel Modeling of the Forest Resource Dynamics // *Mathematical Modelling of Natural Phenomena*. 2009. Vol. 4, №5. pp. 72-88.
- [15] Cherkashin E.A., Badmatsyrenova S. B., Vladimirov I.N., Popova A.K., Davydov A. An optimal control module of sustainable natural resources consumption control synthesis for decision support systems // *37th International Convention on Information and Communication Technology, Electronics and Microelectronics (MIPRO)*, DOI: 10.1109/MIPRO.2014.6859733, 2014. pp. 1100-1105.
- [16] Cherkashin E.A., Popova A.K. Decision support system for management of the forest resources. *Proceedings ICAIIT 2013*. pp. 288-294 (2013).
- [17] Evangelidis K., Ntouros K., Makridis S., Papatheodorou C. Geospatial services in the Cloud. *Computers & Geosciences*. vol. 62, pp. 116-122 (2014).

# Integration of Heterogeneous Data for Baikal-Mongolian Region Seismicity Study

V.V. Paramonov<sup>\*,\*\*,\*\*\*\*</sup>, A.O. Shigarov<sup>\*\*,\*\*\*\*</sup>, G.M. Ruzhnikov<sup>\*,\*\*\*\*</sup>, A.A. Mikhailov<sup>\*,\*\*</sup>,  
A.V. Klyuchevskii<sup>\*\*\*\*</sup> and V.M. Dem'yanovich<sup>\*\*\*</sup>

<sup>\*</sup> *Matrosov institute for system dynamics and control theory of SB RS, Irkutsk, Russia*

<sup>\*\*</sup> *Irkutsk State University, Irkutsk, Russia*

<sup>\*\*\*</sup> *Institute of Earth's crust of SB RAS, Irkutsk, Russia*

<sup>\*\*\*\*</sup> *Irkutsk Scientific Center of SB RAS, Irkutsk, Russia*

{slv, shigarov, ruzhnikov, mikhailov, fedorov}@icc.ru

akluchev@crust.irk.ru, vmdem@mail.ru

Spreadsheets are a very useful and format for storing data has small value and their presentation for humans. Baikal-Mongolian region is a region with a high level of seismicity. Many researchers involved in the study of seismicity of Baikal-Mongolian' region use this format of documents for storing and presentation results of researchers. Integration of multiple different data about one domain that obtained as a result of various observations and studies that allows using various computing models to provide more effective and qualitative researchers. One of the strong integration challenges is the processing of spreadsheets with a different form of data presentation. The paper considers an approach for preparing tabular documents for uploading into a database.

## I. INTRODUCTION

The Baikal-Mongolian region has a high level of seismicity. It represents a serious danger and gives a set of opportunities for studying geological and related to its processes, for example, with emissions of radon. This region presents an interest for scientists of different countries involved in studying of seismological processes and their consequences. The research of this area requires an attraction of a big volume of domain specified data collected. These data may be collected by different researchers and presented in various formats. The significant part of these data has spatial characteristics, that gives the opportunity to generate thematic maps with the results of researchers. On the one hand, a large set of information allows to apply different models and methods for study processes of seismicity, on the other hand, the difference in data presentation formats complicates their integration and further processing. The usage of modern computer-science technologies allows to upload heterogeneous data into the database, integrate them and suggest for research and estimation the seismicity in the region in the convenient form. In general, it may provide a big-data set of information about seismicity a linked with them processes an improve the quality of the research in this area.

Therefore, the development of a digital environment for data upload, aggregation, integration, and tools for their processing is a relevant task. One of the decisions is

the development of such an environment as an information system with the principles of geoportal [1]. It is the entry point to the integration of data with different nature of its origin and a set of methods and interfaces to their processing. We consider that geoportal should be based on the service-oriented approach [2]. This methodology allows using both local services and distributed in the Internet ones for data analysis. It makes possible to use different models and methods developed by other scientists and created as services supporting OGC standards [3].

This paper considers approaches to processing heterogeneous semi-structured data of seismicity domain for uploading into the geoportal system.

## II. BACKGROUND

The research of seismicity and its different influence on the environment require processing a lot of different data. These data are gathered by different institutions and store in different views. The significant part of them represented in documents of Excel format. This format is one of the commonly used for data presentation. Billions of documents are presented in the world in this format [4]. The main reasons for documents such plenty are a widespread distribution of office software, which supports this spreadsheet format, as well as a high degree of documents autonomy, fast data processing and sufficient ease of use. A lot of database systems allow uploading information in this format documents. However, it should be noted that there are no standards of data presentation schemas and forms in spreadsheets. In most cases, it depends on data owner preferences. It can be noted that spreadsheets create by people and for people. In this way even in one institution, it is possible to have spreadsheets that differ in data presentation form, including data on one domain area. Different sources may have a similar format of presentation but have a difference in units of measurement (km and miles, kg and pounds, metres and kilometres etc.). Thereby, such documents convenient to human-readable and understandable, but their automated processing is challenge. The difference in structures of spreadsheets presents difficulties for automated data

analysis, processing, further integration and possibilities of cooperative use. Localisation, heterogeneous, and an absence of remote access to data complicate their effective use in collaborative research.

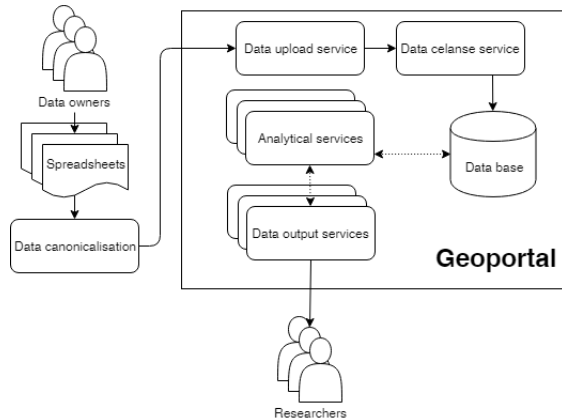

Fig. 1 Scheme of data integration based on geoportals approach

In this way, it needs to create software tools for transforming user formatted spreadsheets to the view suitable for machine-readable. This allows integrating information to a single database. The integration of data can be used to improve quality, to reduce costs and to make it more useful to the public [5]. However, it needs to extract data from different sources. Very often these sources have different levels of details and quality. This difference brings difficulties with data integration and linking with classifiers (dictionaries). Accordingly, the task of creating an environment for simplifying data integration and analysis is a significant challenge.

### III. CONTRIBUTION

This paper is devoted to the development of the environment that provides an uploading user-created data in spreadsheets to the single database. The environment is created by the geoportals type with the set of services.

The major functions of geoportals, presented by services, are:

- *user data uploading* – provides uploading information in spreadsheets form into the geoportals by HTTPS or FTPS protocols;
- *creation of tables* in the geoportals database by the metainformation about them. The general idea of the service consists of that user describes the structure of the spreadsheet by himself. The service uses this metainformation for creation tabular structures and field types. Service allows linking user data with classifiers values as it is required;
- *data cleansing* - intended for correcting and eliminating errors in uploading data;
- *data storage* providing reliable storage and fast access to uploaded data;
- *spatial data creating* allows determine points and polygons on the map by the geocoding of user-data geographic names;

- *analytical services* that based on the using of mathematical models of the seismic signal propagation environment to determine the dynamic parameters of earthquake sources [6] and to estimate recurrent intervals and the probability of strong earthquakes in the region [7].

The services are based on the use of open-source libraries, which makes it possible to adapt them to solving thematic problems by other interested parties, including the use of third-party data. General schema of integration data in geoportals resource is shown in fig. 1.

The geoportals realisation allows to use of internal services and execute of methods (services) distributed on the Internet. The main requirement to external services is compliance with OGC standards.

In the article, we propose an approach for gathering and upload of heterogeneous data about seismic activities in the region and its effects. The required data are contained in earthquake catalogues and bulletins. Also, as a result of scientific research and observations by different scientific groups. Most of these data contain spatial characteristics (sometimes in different units). Accumulated datasets allow modelling seismic processes and present a result both with tabular form and with thematic maps for visual presentation.

### IV. APPROACHES TO HETEROGENEOUS DATA INTEGRATION

Let us consider the general approaches and methods that we use to implement the integration of data about seismic activity in the region.

#### A. Data types and their presentation

The collected data are planned to be used for seismotectonic and seismological studies, including for detailed seismotectonic zoning. For the current stage of research used the following dataset.

The main source of data seismicity is “Earthquake bulletin” - the set of the information (date, time, coordinates, energy class, magnitude, and intensity) about earthquakes. There are used two kinds of bulletins for Baikal and Mongolia regions. The available data contains information about the earthquakes that occurred in the region during the period from 1960 to 2018.

The bulletins of earthquakes in Baikal regions were created by Geophysical Service of the Russian Academy of Sciences. The same bulletins for Mongolian were provided by Institute of Astronomy and Geophysics, Mongolian Academy of Sciences. The structure of data in Russian and Mongolian bulletins is not equal. The labels are made on Russian and Mongolian languages respectively, like that they require cleaning and reconciliation.

There is some information about Radon emissions, indicators of physical condition and plasticity of soils in Baikal region was collected by scientists of Earth’s Crust Institute of SB RAS and needed to upload in the integrate database too. Some of these data collected may contain

spelling and syntactical errors that occur in the process of entering observational data.

Data variety allow using different models and methods for analysing seismological processes. All the data presented in semistructured form. However, they have different schemes and layouts. It means that the structure of headers, the number of columns are different. Accordingly, this complicates their automatic analysis and processing. Also, it needs to transform tables to the flat view, highlighting values, categories and labels [8]. This way of spreadsheet presentation allows simplifying data load into an integrative database using regular ETL-tools or universal services.

### B. Tabular data canonicalisation

To simplify the heterogeneous spreadsheets upload and further automated processing, it is proposed to transform tabular data in spreadsheets to canonical form [8]. The operation consists in tabular data analysis and interpretation for recovering cell-role pairs where a role is defined as an entry, label, or category, as well as entry-label, label-label, and label-category pairs [8, 9]. The TabbyXL and TabbyPdf [8, 9] tools are used for transformation to the canonical form. The tools recover relationships between elements in the tables. In more detail, the process is presented in papers [8, 9].

The canonical form of the data allows recovering all relationships between table elements. In this way, we may consider the canonical form as a relational form of the table.

Its topmost row contains field (attribute) names. Each of the remaining rows is a record (tuple). It obligatorily includes the field named DATA that contains entries. Each recovered category becomes a separate field that contains its labels. Any record presents recovered relationships between entry and one label in each category. Usually, each record is unique within a canonical table [8]. Such transformation offers data preparation for unloading to relational integrating database of the environment (geoportal).

### C. Data upload and cleansing

Spreadsheets may contain not tabular data also. For example, they may present some additional information regarding the worksheet as whole or specific sections. To upload data into an integrated relational table it needs only to extract tabular data.

Extracted tables should be transformed into the canonical form [8, 10] and stored in CSV format. This format is an intermediate format for data uploading to the geoportal.

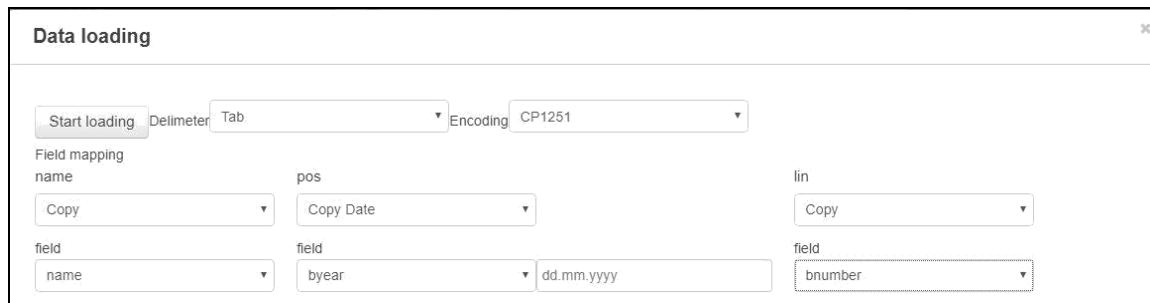

Fig. 2 Data description interface.

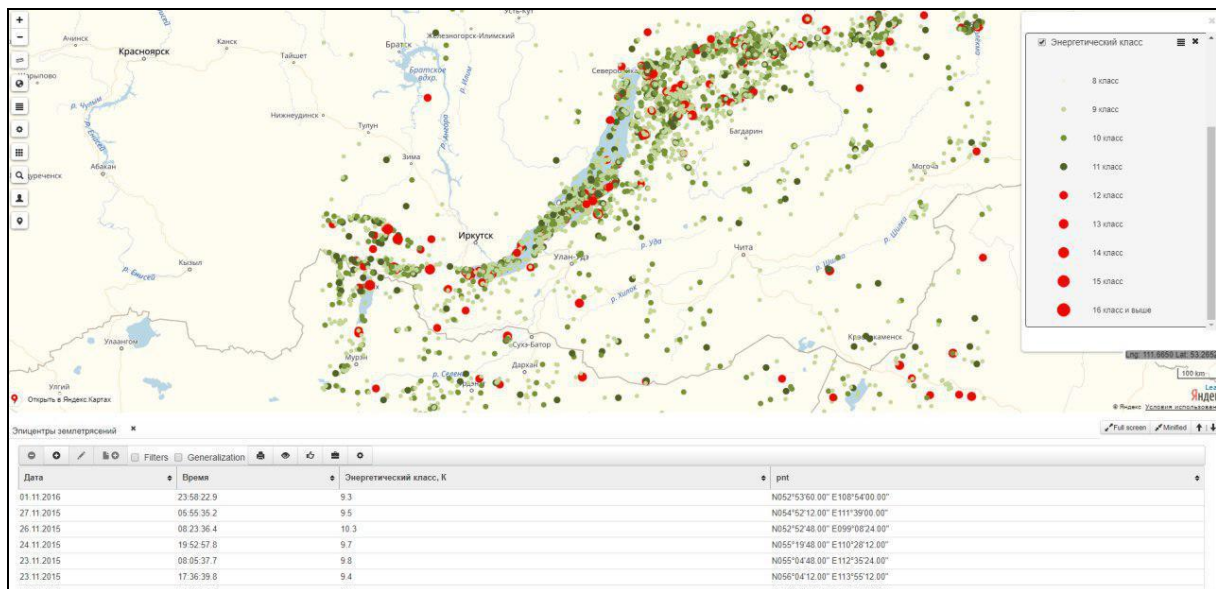

Fig. 3 Example of the thematic map fragment

It should be noted that this format could not store any information about the data type of elements. However, data owners not always add information about data types of spreadsheets cells. Statistical data, that presented the Statistical Agency of Russia does not contain this information too. In this regard, the CSV format is used to upload data to geoportal. The service for uploading CSV documents to the geoportal was created. The service allows uploading documents using HTTPS or FTPS protocols.

This service requires adding additional information about data types and possible links with classifiers values. When data owners upload document they should specify a data type (string, integer, classifier value, etc.) for the field and measurement units (if necessary). The interface of data description service is presented in fig. 2.

For the effective sharing of information, it is necessary to carry out data normalisation operations [11]. It needs to convert them to simple types of data presented in the fields of the table, as well as to bind values to hierarchical directories. The interface of geoportal data upload allows adding a structural description for each column of the created by the loaded data table. The user must specify whether the field is a reference value (address, plant name, insect, service code, etc.), unit of measurement (inch, degree, m<sup>3</sup>, etc.), text, etc. according data description stage.

Some of collected by scientists' data may have mistakes (errors). They arise as a result of misprints, spelling mistakes, invalid usage of date or currency delimiters, repeated values, faults of text recognition etc. In this regard, data cleansing is required before the integration. It is one of the important steps in data integration processes. It embodies many aspects such as detection and automatic correction of spelling mistakes, incorrect values, logical inconsistencies, and missing data [12].

Service for data cleaning allows you to identify and, in some cases, correct errors and inconsistencies in raw (user) data. The goal of cleaning is to improve data quality that enforces effective data processing. This service provides correction of units' delimiters, date formats, and data for comparison with classifiers values. The apparatus of regular expressions and phonetic algorithm Polyphon [12] are used for this procedure.

## V. DATA VISUALIZATION AND DISPLAYING

The geoportal allows present data that obtained as a result of processing (analysing in the form of the tables and as thematic maps.

The uploaded information is presented in the relational view. Some operations, such as data aggregation are available after uploading. Geocoding of the areas is automatically by matching geographic names in cleaned user data with classifiers values. The uploaded in geoportal geographic classifiers contain names of administrative areas and settlements in Siberia and Mongolia.

It is possible to build a thematic map of earthquakes for uploaded in geoportal data. Results of operations will be shown on the map, fig 3.

## VI. EXAMPLES OF ANALYTICAL SOME SERVICES

The main functions of the geoportal are implemented in the form of services. The analytical services of the environment created at this stage of the study, which are based on the use of mathematical models of the medium for the propagation of seismic signals to determine the dynamic parameters of earthquake sources and to estimate the recurrence intervals and the probability of strong earthquakes in the region. The services being developed are based on the use of OpenSource libraries, which makes it possible to adapt them to solve complex thematic problems by interested users, including other data.

### A. *Service for calculating the density of point objects in the cells of a regular grid*

A service for calculation density of points in the cells of a regular grid has been developed. A layer of vector objects is a service input. As output, we get the number of objects in the cells of a regular grid, in GeoTIFF [13] format. The user, can specify the size of the cell and the treatment area. Earthquake epicentres or geographic objects reviewed in the area can be analysed as reviewed objects.

### B. *Service for calculating the density of linear features in the cells of a regular grid*

The service for calculating the density of linear objects in the cells of a regular grid was developed. The input data of the service is the vector objects layer. The output is the total length of the linear objects in the cells of a regular grid, represented in GeoTIFF format.

### C. *Service for statical analysis*

The service for statically analysis of geospatial data was created. The service represented as a compiled dynamic library written in C++ language for WPS method of ZOO server. The mathematical methods into the library use methods of Alglib library [14]. Alglib allows implementing many statistical and algebraic operations over scalar and vector data.

In our case, input data represented two thematic layers in GeoTIFF format. Spatial data in these layers are converted into one-dimensional arrays. After that regression and correlation coefficients are determined. This kind of analysis helps to understand and estimate data dependence and influence. The output data is a conclusion about analysed data dependence.

## VII. CONCLUSION

The paper presents an approach to integrate heterogeneous data about seismic activity in Baikal-Mongolian' region for their further joint use. The approach is based on transformation initial tabular data to canonical form, adding meta-information, cleansing them and uploading to the relational table in the informational environment of geoportal type.

The created services and methods were integrated into the prototype of geoportal of Irkutsk Scientific Center (<http://atlas.isc.irk.ru/>).

The approach may be used also for processing data of different domains.

Systems and Computing, vol 852. Springer, Cham DOI: [https://doi.org/10.1007/978-3-319-99981-4\\_28](https://doi.org/10.1007/978-3-319-99981-4_28)

- [13] Shekhar S., Xiong H. Encyclopedia of GIS. Springer, 2008 – 1370 p.
- [14] Bochkano S.: ALGLIB, <http://alglib.net>

#### ACKNOWLEDGEMENT

The work was financially supported by RFBR grant 17-57-44006, RFBR and Government of Irkutsk Region grant 17-47-380007. Experiments were performed on the resources of the Shared Equipment Centre of Integrated information and computing network of Irkutsk Research and Educational Complex <http://net.icc.ru>.

#### REFERENCES

- [1] Granell C., etc. Conceptual Architecture and Service-Oriented Implementation of a Regional Geoportal for Rice Monitoring. // ISPRS International Journal of Geo-Information. 2017. Vol. 6. Issue 7. 191.
- [2] Bychkov I.V., Ruzhnikov G.M., Paramonov V.V., Shumilov A.S., Fedorov R.K., Levi K.G., Demberel S. Infrastructural approach and geospatial data processing services in the tasks of territorial development management // Proc. 1st Intern. Geographical Conf. of North Asian Countries on China-Mongolia-Russia Economic Corridor: Geographical and Environmental Factors and Territorial Development Opportunities. 2018. Vol. 190.
- [3] OGC® Standards and Supporting Documents <https://www.opengeospatial.org/standards>
- [4] Koci, E., Thiele, M., Romero, O., Lehner, W.: Table identification and reconstruction in spreadsheets. In: Dubois, E., Pohl, K. (eds.) Advanced Information Systems Engineering. pp. 527–541. Springer International Publishing, Cham (2017)
- [5] Ying Zhang, Chaopeng Li, Na Chen, Shaowen Liu, Liming Du, Zhuxiao Wang, Miaomiao Ma. Semantic-Based Geospatial Data Integration With Unique Features (Chapter 12). // Geospatial Intelligence: Concepts, Methodologies, Tools, and Applications.
- [6] Ключевский А.В., Демьянович В.М. Оценка влияния модели среды распространения сейсмических сигналов на определение динамических параметров очагов землетрясений Байкальского региона // Вулканология и сейсмология. 2003. № 2. С. 58-71.
- [7] Klyuchevskii A.V., Dem'yanovich V.M., Bayar G. Large earthquakes in the Baikal region and Mongolia: Recurrence time and probability // RUSSIAN GEOLOGY AND GEOPHYSICS 46 (7): 731-745. 2005.
- [8] Shigarov A., Paramonov V., Belykh P., Bondarev A. Rule-Based Canonicalization of Arbitrary Tables in Spreadsheets // Communications in Computer and Information Science. Springer. 2016. Vol. 639, pp. 78-91. DOI: [https://doi.org/10.1007/978-3-319-46254-7\\_7](https://doi.org/10.1007/978-3-319-46254-7_7)
- [9] Shigarov, A., Altaev, A., Mikhailov, A., Paramonov, V., Cherkashin, E.: Tabbypdf: Web-based system for pdf table extraction. In: Damaševicius, R., Vasiljevič, G. (eds.) Information and Software Technologies. pp. 257–269. Springer International Publishing, Cham (2018)
- [10] Shigarov A.O., Mikhailov A.A. Rule-based spreadsheet data transformation from arbitrary to relational tables. Information Systems 71, pp. 123 – 136 (2017) <https://doi.org/https://doi.org/10.1016/j.is.2017.08.004>
- [11] Ericsson M., etc. A Study of the Effect of Data Normalization on Software and Information Quality Assessment // Software Engineering Conference (APSEC, 2013 20th Asia-Pacific) 2013. – pp. 55-60
- [12] Paramonov V., Shigarov A., Ruzhnikov G., Cherkashin E. (2019) Phonetic String Matching for Languages with Cyrillic Alphabet. In: Borzemski L., Świątek J., Wilimowska Z. (eds) Information Systems Architecture and Technology: Proceedings of 39th International Conference on Information Systems Architecture and Technology – ISAT 2018. ISAT 2018. // Advances in Intelligent

# Transforming Concept Maps and Spreadsheet Data for Ontology Engineering

N.O. Dorodnykh and A.Yu. Yurin

Matrosov Institute for System Dynamics and Control Theory, Siberian Branch of the Russian Academy of Sciences (ISDCT SB RAS), Irkutsk, Russia  
iskander@icc.ru

**Abstract** – There are different approaches for constructing ontologies based on direct manipulation of subject domain concepts or extraction information from existing data sources (e.g., models, texts, databases, spreadsheets and etc.). Ontology Design Patterns (ODPs) are also a way to improve the efficiency of the ontology engineering process and to fix typical solutions. In turn, the fixed solutions help to avoid some mistakes. In this paper we present an approach based on analysis and transformation of conceptual models serialized in XML-like formats for constructing ODPs. These ODPs used along with spreadsheets analysis to build ontology instances. We propose to apply a Transformation Model Representation Language (TMRL), a Knowledge Base Development System (KBDS), and an OWL converter prototype (TabbyOWL) for supporting our approach. The Web Ontology Language (OWL) is considered as a target ontology format, the IHMC CmapTools concept maps are used as the source concept models. The main steps of our approach and an illustrative example are presented.

## I. INTRODUCTION

Ontologies remain the main way to support the software development, including the design of intelligent systems and its knowledge bases. There are specialized methods and software used for ontology engineering, which can be divided into the following main groups:

- semantic Wiki (combines the properties of wiki systems with semantic statements, for example, Semantic MediaWiki);
- universal ontology editors (e.g., Protégé, ONTOedit, Fluent Editor, Menthor Editor, Semaphore Ontology Editor, Synaptica, Thesaurus Master, VocBench, etc.);
- advanced ontology editors (e.g., OntoStudio, Anzo, Information Workbench, Metaphacts, OpenSemanticFramework, Poolparty, TopBraid, etc.).

All these tools conform to W3C consortium standards and well proved in solving various tasks. However, they are designed for the direct manipulation of subject domain concepts when creating ontologies and don't use any automated or semi-automated methods for extraction concepts and relationships from existing data sources (models, texts, databases, and etc.). In addition, they have a weak support of visual modeling for domain-specific

knowledge. So, domain experts prefer to use system-wide means (e.g., concept maps, mind maps, fishbone diagrams, IDEF models, UML models, domain charts, etc.) to describe subject domain models. Meanwhile, in the most cases created models remain static graphic artifacts and are not used for automated generation of knowledge base and ontologies in the form of source codes and specifications.

The brief analysis of some tools for conceptual modeling (Table 1) has shown not only the absence of common standards for models representation, but the use of XML-like formats that are incompatible with each other. These formats can be processed for automatic retrieving information about concepts and relationships, in order to form the ontologies in future [1-3]. In turn, extracted information can be used to create Ontology Design Patterns (ODPs). Using ODPs is a way to improve the efficiency of the ontology engineering process and fix typical solutions. These solutions help to avoid some mistakes.

It should be noted that automated analysis and transformation of conceptual models provides to obtain ontologies only at the abstract level (T-Box level), that describes a set of interrelated classes (an ontology

TABLE I. TOOLS FOR CONCEPTUAL MODELING

Tool name	Type of models	File format	XML support
CmapTools	concept maps	.cmap	+ (XTM [3], CXL)
VUE	concept maps	.vue	+
Freeplane	mind maps	.mm	+
TheBrain	mind maps	.brainzip	+
Mind Manager	mind maps, flowcharting	.mmap	+
Xmind	fishbone diagrams, mind maps	.xmind	+
Coggle	flowchart, mind maps	.mm	+
yEd	flowchart, , mind maps, ER model	.xml	+ (Graph ML)
IBM Rational Rose	UML	.mdl	+ (XMI)
Star UML	UML	.mdj	+ (XMI)

The contribution of this work was supported by the Russian Science Foundation under Grant No.18-71-10001.



schema). It is rather difficult to obtain specific knowledge (instances and their values) on the basis of conceptual models. For this purpose it is necessary to use some existing data. This data can be presented, in particular, in the form of spreadsheets. Processing and extracting knowledge from them is also a relevant task today.

In this paper we present an approach for complex ontology engineering at:

- the T-Box level based on automated analysis and transformation of conceptual models, in particular, concepts maps serialized in XML-like formats [4]. The main results of this transformation are OWL ontology schemas in the form of ODPs (content ontology templates) [5];
- the A-Box level based on automated analysis and transformation of spreadsheet data in the Excel (XLSX) format. The main results of this transformation are domain ontologies, which used ODPs obtained earlier.

We propose to use a Transformation Model Representation Language (TMRL) [6], a Knowledge Base Development System (KBDS) [7] and a prototype of a TabbyOWL tool to support our approach. Web Ontology Language (OWL) is considered as a target ODPs format, the IHMC CmapTools concept maps format is used as the format of source conceptual models.

## II. BACKGROUND AND RELATED WORKS

### A. Model transformations

Transformation is a fundamental topic in the field of computer science and software engineering. In the most cases transformations are described by rules, which set correspondence between constructs of source and target languages [8]. These rules can be used for transformation of different software engineering artifacts: UML and feature models, specifications of interfaces, data and component schemas, source codes, and etc.

Model transformations can be classified by the following grounds [9-10]: (1) results: Model-to-Model (M2M); Model-to-Text (M2T) and Text-to-Model (T2M); (2) modeling languages: endogenous and an exogenous; (3) abstraction level of models: vertical and horizontal; (4) direction of transformation: unidirectional and bidirectional.

In the most cases model transformations are implemented with the aid of domain-specific languages: QVT (Query/View/Transformation) [11], ATL (ATLAS Transformation Language) [12], VIATRA2 (VIual Automated model TRAnsformations) [13], GReAT (Graph REwriting And Transformation) [14] and others. The main disadvantage of these languages is the high requirements for the user qualification in the field of programming. In particular, the user needs to know: (1) the syntax and semantics of a selected model transformation language (that can be quite complicated); (2) a certain meta-modeling language (e.g., MOF (Meta-Object Facility), Ecore, KM3 (Kernel Meta Meta Model), etc.) that is used to describe the source and target models;

and (3) some related (additional) languages, for example, Object Constraint Language (OCL). Furthermore, most of transformation languages are oriented on certain software platform, in particular, Eclipse.

In this connection we propose to use our means that support the model transformations, namely, Transformation Model Representation Language (TMRL) [6] and Knowledge Base Development System (KBDS) [7]. These means are web-based and used the principles of visual programming.

### B. Ontology design patterns

The ontology development is a rather difficult and time-consuming task. There are different approaches to making this process more effective. One of such approaches, actively developing over the last ten years, is of the use of Ontology Design Patterns (ODPs) [5]. ODPs fix typical solutions in a certain domain and help to avoid some mistakes. There are six types of ODPs [5]: structural, correspondence (re-engineering and alignment), content, reasoning, presentation (naming and annotating) and lexico-syntactic. At the same time, content and structural ODPs (including logical and architectural ODPs) are the most popular types of ODPs. Content ODPs encode conceptual design patterns and provide solutions for tasks of domain modeling. Logical ODPs are content-independent (i.e. are independent from a certain subject domain) and depend on a representation formalism used. Architectural ODPs affect the overall shape of the ontology: their aim is to constrain "how the ontology should look like".

Thus, the use of ontology fragments in the form of structural and content ODPs can simplify and speed up ontology engineering.

Currently, several catalogs of ODPs are created and developed [15]. It should be noted that such catalogs, as a rule, are focused on a specific subject area, therefore, they cannot have completeness and universality, but they can be useful for ontology developers. In this connection is very urgent adding new ODPs to these catalogs.

### C. Methods and tools for constructing ontology design patterns

There are at least two different approaches for constructing ODPs [16]:

- direct manipulation of subject domain concepts and relationships;
- using automated and semi-automated methods for extraction ODPs from existing data sources: ontologies, texts, databases, conceptual models, and etc. [17-19].

Today, there are few researchers who construct ODPs on the basis of conceptual model transformations. They develop methods and means for the creation ontology schemas (ontologies at the T-Box level) and ontology instances (ontologies at the A-Box level).

For example, a metamodel-driven model transformation approach for interchanging data between UML/OCL and OWL/SWRL is proposed in [20]. The

REVERSE Rule Markup Language (R2ML) and ATL are used for intermediate and final description of transformation rules. An approach for transforming UML class diagrams into OWL ontologies using the QVT standard is presented in [21]. There are other examples of transforming conceptual models into OWL ontologies: UML models [22-24], concept maps [25], ER schemas [26]; SBVR statements [27].

Some researchers obtain ontologies from XML data. T.Rodrigues et al. [28] present a notation for mapping XML schemas into OWL. M.J. O'Connor and A.K. Das [29] propose a domain-specific language – XMLMaster designed for converting XML documents into arbitrary OWL ontologies. A set of patterns for the direct automatic transformation of XML schemas into OWL ontologies (OWL 2 RL) presented in [30]. This approach involves the normalization, filtering and transformation of XML data and implemented in Java as a Janus tool.

Most of the aforementioned solutions have the following drawbacks:

- A domain-specific orientation (an “ad-hoc” character of solutions): they are suitable for specific case studies and concrete tasks.
- A rigid algorithmic definition of correspondences between the elements of the source and target formats: any changes of transformation rules require the changes in the program source codes of the corresponding software.
- A programmers orientation, instead domain experts, analysts and knowledge engineers.
- A rather complicated implementation: the use of a set of software for transformation even at one stage.

Our approach for OWL content ODPs engineering resolves some of these drawbacks. This approach designed for transformation of conceptual models sterilized in the XML-like format. The IHMC CmapTools concept maps are used as the source conceptual models.

#### D. Spreadsheet Data Analysis and Transformation

In this paper we offer to use the spreadsheets as the source for ontology instances. There are several recent studies that deal with spreadsheet data transformation. Such tools as RDF123 [31], csv2rdf4lod [32], Datalift [33], Any2OWL [34], Excel2OWL [35] are used to solve issues of converting spreadsheet data to RDF or OWL formats. Some of the solutions also include own domain-specific languages: XLWrap [36], Mapping Master [37] and RML [38].

Quite a few solutions are available in this area, especially for the generation of RDF documents. However, the generation of ontologies in the OWL format is usually poorly supported.

This work is a part of the project for development of a framework for creating systems of data extraction from arbitrary spreadsheets [39]. One of the elements of this project is a TabbyXL tool for spreadsheet data

canonicalization [40]. Thus, we create an OWL generator focused on the format of canonical TabbyXL tables.

### III. METHODOLOGY OF MODEL TRANSFORMATIONS

In our case ontology engineering at the T-Box and A-Box levels involves a set of following sequential transformations:

1. conceptual models to an ontology schema (at the T-Box level);
2. arbitrary spreadsheet data to a canonical form (as an intermediate data representation);
3. canonical tables to ontology instances (domain ontology at the A-Box level).

#### A. Formalization

The transformation of conceptual models presented in the form of XML-like concept maps formally described as follows:

$$TR_1 : CM^{XTM} \rightarrow CODP^{OWL},$$

where  $CM^{XTM}$  is a source concept map in the XML Topic Maps (XTM) format,  $CODP^{OWL}$  is a target content ODP in the OWL 2 DL format,  $TR_1$  is a set of rules for transformations of conceptual models.

$$CM^{XTM} = \langle T, A, R, S \rangle, \quad (1)$$

where  $T$  is a set of topics,  $A$  is a set of associations;  $R = \{R_T, R_A\}$ , where  $R_T$  is a set of relationships between  $T$  elements,  $R_A$  is a set of relationships between  $A$  elements;  $S$  is a set of scopes.

Using (1)  $CM^{XTM}$  elements can be described in detail:

$T = \{t_1, \dots, t_n\}, t_i = \langle name, occurrence \rangle, i \in \overline{1, n}$ , where  $t_n$  is a  $n$ -topic that represents a resource, this resource acts as a proxy for a subject. The relationship between a topic and its subject is defined as reification. The subject reification provides to assign topic characteristics (a name, an occurrence or a topic role in an association) to the topic that reifies it. *Name* is an element that specifies a topic name. *Occurrence* is an element that specifies resource supplying information relevant to the topic, i.e. provides a URI reference to a resource or some data.

$A = \{a_1, \dots, a_n\}$ , where  $a_n$  is a  $n$ -association that presents a relationship between one or more topics.

$R_T = \{r_t^{subld}, R_T^{insOf}\}$ , where  $r_t^{subld}$  is an optional subject identity that specifies the subject reified by the topic, i.e. the relationship between the topic and the resource or its parent;  $R_T^{insOf} = \{r_1^{insOf}, \dots, r_m^{insOf}\}, r_i^{insOf} = \langle t_{i,1}, t_{i,2} \rangle, i \in \overline{1, n}$ , where  $r_i^{insOf}$  is a binary relationship between topics.

$R_A = \{r_a^{subId}, R_A^{insOf}\}$ , where  $r_a^{subId}$  is an optional subject identity that specifies the subject reified by the association, i.e. the relationship between the association and the resource or its parent;  $R_A^{insOf} = \{r_1^{insOf}, \dots, r_m^{insOf}\}$ ,  $r_j^{insOf} = \langle a_{j,1}, a_{j,2} \rangle$ ,  $j \in \overline{1, m}$ , where  $r_j^{insOf}$  is a binary relationship between associations.

$S = \{s_1, \dots, s_n\}$ , where  $s_n$  is a  $n$ -scope that presents the validity extent of a topic characteristic assignment.

$CODP^{OWL} = \langle C, OP, DP \rangle$ , where  $C$  is a set of classes,  $OP$  is a set of object properties,  $DP$  is a set of data type properties.

The transformation of arbitrary spreadsheet data, which are presented in the form of Excel tables (XLSX format), formally described as follows:

$$TR_2 : SD^{XLSX} \rightarrow CT^{XLSX},$$

where  $SD^{XLSX}$  is an arbitrary source spreadsheet data in the XLSX format,  $CT^{XLSX}$  is a target canonical (relational) table in the XLSX format,  $TR_2$  is a set of rules for transformations of arbitrary spreadsheets.

We formalize a transformation process of canonical tables ( $CT^{XLSX}$ ) to domain ontology codes using  $CODP^{OWL}$  as follows:

$$TR_3(CODP) : CT^{XLSX} \rightarrow DmOnt^{OWL},$$

where  $DmOnt^{OWL}$  is a domain ontology in the OWL format,  $TR_3$  is a set of rules for transformations of canonical tables.

### B. Algorithm for concept map transformations

The algorithm of transformation based on above formalization ( $TR_1$ ) and includes five main steps:

*Step 1:* Constructing conceptual models. A domain expert represents his/her knowledge in the form of a model that describes domain concepts and relationships using domain-specific visual notations. In our case experts use IHMC CmapTools concept maps.

*Step 2:* Serializing conceptual models in the XML-like format. On this step an obtained concept map is represented in the XML-based format by means of software used for conceptual modeling. In our case IHMC CmapTools save the models in the XTM format for further transformations.

*Step 3:* Analyzing the XML structure of a concept map. This step involves extracting elements, their attributes, and relationships from a XML tree.

*Step 4:* Forming a content ODP in the OWL format. The main objective of this step is to obtain ontological fragments in the form of a set of classes and their relationships (object and data type properties), which describe a certain domain and based on the extracted XML elements.

*Step 5:* Editing a content ODP. This stage is additional and represents a refinement (modification) of an ODP OWL code obtained (if necessary) with the aid of various ontological modeling tools, for example, Protégé.

For implementation of steps 3 and 4 we use our means: a declarative domain-specific language called Transformation Model Representation Language (TMRL) [6] and web-based software called Knowledge Base Development System (KBDS) [7]. TMRL has a narrow specialization; it is designed for converting conceptual models into knowledge bases only. KBDS is a framework for using and executing TMRL.

Thus, the user forms a transformation scenario on TMRL for transforming models. This scenario is a set of rules for transformation of XML elements of a concept map to ontological constructs. Each rule contains a correspondence between elements of the source and target metamodels with a certain priority (sequence) of this rule for an interpreter. A XML Schema is used as a source metamodel for the XML-based concept map. The OWL language description is used as a target metamodel for content ODPs. The main correspondences between XTM and OWL metamodel elements are the followings:

- topicMap  $\rightarrow$  Ontology
- topic  $\rightarrow$  Class
- topic/instanceOf  $\rightarrow$  subclassOf
- subjectIdentity/topicRef  $\rightarrow$  equivalentClass
- baseName  $\rightarrow$  rdf:about
- association  $\rightarrow$  ObjectProperty
- association/instanceOf  $\rightarrow$  subPropertyOf
- association/subjectIdentity/topicRef  $\rightarrow$  equivalentProperty
- member roleSpec/topicRef  $\rightarrow$  domain/range
- occurrence/resourceData  $\rightarrow$  DatatypeProperty

There are three types of correspondences for elements:

- *An one-to-one correspondence (equivalence)* – each XML Schema element can be associated with the one of an OWL metamodel element;
- *An ambiguous correspondence (synonymy)* – several XML Schema elements correspond to one of an OWL metamodel element,
- *An indistinguishable correspondence (homonymy)* – one of the XML Schema element corresponds to several OWL metamodel elements.

Extreme cases:

- *A redundancy* – when individual XML Schema elements cannot be mapped to any OWL metamodel elements.
- *An expressive ability lack* – individual OWL metamodel elements do not have a corresponding XML Schema elements.

Thus, the main result of this algorithm is a set of content ODPs, which define an ontology schema at the T-Box level.

### C. Algorithm for spreadsheet tables transformations

The algorithm of transformations based on above formalization ( $TR_2$  and  $TR_3$ ) and includes two main steps:

*Step 1:* Transforming source spreadsheet data with an arbitrary layout to the canonical (relational) form. This step consists of the following main actions:

1.1 Analyzing the XLSX file of spreadsheet data by using Cells Rule Language (CRL) rules [40]. CRL is a domain-specific language for expressing table analysis and interpretation rules. A set of the rules can be implemented for a specific task characterized by requirements for source and target data.

1.2 Canonicalization. The process of table canonicalization begins with loading tabular data from XLSX files via Apache POI. Recovered semantics (entries, labels, and categories) allow transformation of the source spreadsheet data into the canonical form. The canonical form requires the topmost row to contain field (attribute) names. Each of the remaining rows is a record (tuple). It obligatorily includes the field named DATA that contains entries. Each extracted category constitutes a field that contains its labels. Each record presents recovered relationships between an entry and labels in each category.

Thus, let us formally define the canonical table for our case on the basis of [41]:

$$CT^{XLSX} = \{DATA, RowHeading, ColumnHeading\},$$

where DATA is a data block that describes literal data values (named “entries”) be-longing to the same datatype (e.g., numerical, textual, etc.), *RowHeading* is a set of row labels of the category, *ColumnHeading* is a set of column labels of the category. The values in cells for heading blocks can be separated by the “[” symbol that is in-tended to divide categories into subcategories. Thus, the canonical table denotes hierarchical relationships between categories (headings). Detailed description of this process is presented in [40]. The result of this step is tables in the unified canonical form prepared for their further automated processing.

*Step 2:* Generating OWL domain ontology from canonical tables using ODPs. This step consists of the following main actions:

2.1 Semantic canonical table interpretation using obtained ODPs. This process is semi-automatic and aims to linking *RowHeading* and *ColumnHeading* cell values with entities of previously obtained ODPs (the ontology schema at the T-Box level). Each canonical table corresponds to a specific class of this ontology. In this case, a set of concept candidates (classes and data properties) for each *RowHeading* and *ColumnHeading* cell is determined basing on the obtained ontology schema. A cell value with separator (“[”) is interpreted as a hierarchy of either classes (“subClassOf” construction) or

data properties (“subPropertyOf” construction). Thus, ontology concepts, which are closest to each label, are determined. For this purpose, it is necessary to calculate an aggregated assessment (for example, a linear convolution or any other proximity measure) for all concept candidates and select a referent concept with the maximum rating. Note that context for canonical table and ontology schema should be equal. Otherwise, the aggregated assessments would be low due to the lack of correspondences between labels and ontology entities.

2.2 Forming domain ontology at the A-Box level. The main objective of this action is to generate OWL axioms for representation of instances based on the obtained canonical table to supplement the existing ontology schema (the content ODP) with concrete instances. The obtained canonical table is divided into blocks (row sets) that correspond to a certain category group from *RowHeading* and *ColumnHeading*. At the same time, this group is annotated with a class from the ontology schema. Thus, each such row set is interpreted as an ontology instance and entities from DATA corresponding to data property values of instance.

### D. Implementation

We implement our approach using TMRL, KBDS, TabbyXL and an OWL converter prototype, which provide  $TR_1$ ,  $TR_2$ ,  $TR_3$  transformations.

TMRL [6] is a domain-specific language designed for representation and storing transformation models. The TMRL grammar is context-free (LL(1)) and describes the transformations in a declarative form. The TMRL specifications satisfy the requirements of accuracy, clarity and completeness.

TMRL contains 15 lexemes: Transformation Model, Source Meta-Model, Target Meta-Model, Transformation, Elements, attributes, Relationships, is associated with, is, to, Rule, priority, or, and, Call. Seven lexemes from this list are used to describe the source and target metamodels; 7 are used to describe the transformation rules; 1 is used for calling other KBDS transformation modules.

The TMRL program consists of three main blocks, which describe source, target metamodels elements and relationships as well as transformation rules.

Below are the fragments of the TMRL program for XTM concept maps transformation.

Block 1. Description of the elements and relationships of the source metamodel:

```
Source Meta-Model for CmapTools (XTM) concept maps {
  Elements [
    topicMap attributes (id),
    topic attributes (id),
    instanceOf,
    subjectIndicatorRef attributes (type, href),
    baseName,
    baseNameString,
    association attributes (id),
    topicRef attributes (type, href),
    member,
    roleSpec
  ]
  Relationships [
    topicMap is associated with topic,
```

```

topic is associated with instanceOf,
instanceOf is associated with
subjectIndicatorRef,
topic is associated with baseName,
baseName is associated with
baseNameString,
topicMap is associated with
association,
association is associated with
instanceOf,
instanceOf is associated with
topicRef,
association is associated with member,
member is associated with roleSpec,
roleSpec is associated with
subjectIndicatorRef,
member is associated with topicRef
    ]
} ...
    
```

### Block 3. Description of transformation rules:

```

Transformation of CmapTools (XTM) concept maps to
Logical Rules {
Rule (topic, baseNameString) to Fact priority 1 [
Fact(name) is topic or baseNameString
]
Rule (topic, baseNameString) to Rule priority 2 [
Rule(name) is topic or baseNameString
]
Rule (topic, baseNameString) to FactSlot priority 3 [
FactSlot(name) is topic or baseNameString
]
Rule (member, topicRef) to RuleCondition priority 4 [
RuleCondition(name) is member or topicRef
RuleCondition(operator) is "AND"
]
}
...
    
```

Knowledge Base Development System (KBDS) [7] is a web-oriented tool that supports TMRL.

KBDS has a client-server architecture and includes the following main modules:

- the ontology editor that provides a visual representation and editing knowledge in the form of a graph;
- the meta-model editor that provides a visual representation and editing the meta-model elements;
- the transformation model editor that provides a visual representation and editing the transformation rules.
- software components (modules), which provide a synthesis of the ontological model based on the analysis and transformation of source conceptual models and the code generation of ODPs in the OWL format.

KBDS [7] is designed using a Model-View-Controller (MVC) design pattern, PHP and Yii2 framework. jQuery and jsPlumb libraries were used to build graphic editors.

TabbyXL [39] is a command-line tool for spreadsheet data canonicalization. This tool is used to produce flat relational (normalized) spreadsheet data from semi structured tabular data. The tool operates with XLSX and CSV formats. Data structures for representing table elements (cells, entries, labels, and categories) are Java classes developed in accordance with naming conventions of JavaBeans 5 specification.

OWL converter prototype is a tool for transformation of canonical tables into OWL ontology at the A-Box level.

The input data for a converter is a set of transformation rules and a source canonicalized table. The output data is an ontology containing instances. Thus, the main result is the domain ontology that reflects the abstract level of domain knowledge in terms of classes and their properties and contains specific axioms. These axioms can be useful for their further usage in intelligent systems for solving various types of domain issues.

## IV. TRANSFORMATION EXMAPLE

In this section we present an example of transformation of a conceptual model in order to obtain a fragment of an ontology schema. The subject domain of industrial safety inspection (ISI) is used for illustration.

ISI is an activity in the field of safety management of industrial equipment. It includes the tasks of monitoring, diagnosing, and forecasting technical conditions. Only the complete and adequate subject domain models provide the proper solution of these tasks. In turn, subject domain models can be presented in the form of ontology and designed with the aid of ODPs. But, the brief analysis showed the absence ODPs for ISI tasks.

So, in our case we create some content ODPs on the basis of a transformation ISI models corpus [42]. In turn, these models were collected when performing research projects with the Irkutsk research and design institute of chemicaland petrochemical engineering (IrkutskNIIHimmash).

Steps 1 and 2 are performed with the use of IHMC CmapTools. Figure 1 shows a fragment of a concept map that describes a degradation process – the main concept in the field of technical equipment aging.

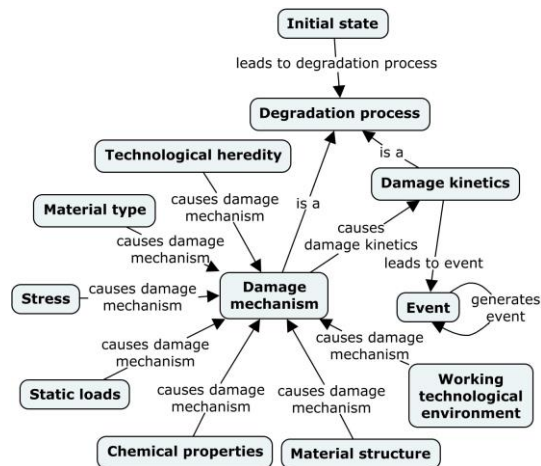

Figure 1. A fragment of a concept map.

Step 3 is performed using a XML-analyzer of KBDS. In our case one of existed KBDS modules is used.

Step 4. The TMRL program for transformation is created by a user through a visual transformation model editor (the KBDS module) [7]. The user defines correspondences between source and target metamodel elements and assigns priority for each transformation rule. KBDS transformation component uses this transformation

model and translates a XTM concept map to an OWL code of a content ODP. A fragment of an OWL code (RDF/XML syntax) for the content ODP obtained is presented below:

```
<owl:Class rdf:about="DegradationProcess" />
  <owl:Class rdf:about="DamageMechanism">
<rdfs:subClassOf rdf:resource="DegradationProcess" />
  </owl:Class>
  <owl:Class rdf:about="DamageKinetics">
<rdfs:subClassOf rdf:resource="DegradationProcess" />
  </owl:Class>
  <owl:ObjectProperty
    rdf:about="leadsToDegradationProcess">
<rdfs:domain rdf:resource="#InitialState" />
<rdfs:range rdf:resource="#DegradationProcess" />
  </owl:ObjectProperty>
<owl:ObjectProperty rdf:about="causesDamageMechanism">
  <rdfs:domain>
    <owl:Class>
  <owl:unionOf rdf:parseType="Collection">
    <rdf:Description
      rdf:about="MaterialType" />
    <rdf:Description rdf:about="ChemicalProperties"
      />
    <rdf:Description rdf:about="MaterialStructure"
      />
    <rdf:Description ...
```

Step 5 was skipped because of the code obtained does not require any changes.

The resulted content ODPs can be used for further ontology engineering and formation of ontology instances (A-Box level).

## V. CONCLUSION

The ontology engineering is a complex and time-consuming process. ODPs are a way to improve the efficiency ontology engineering process and fix typical solutions. In turn, the fixed solutions help to avoid some mistakes.

In this paper we present the approach based on analysis and transformation of concept maps serialized in XML-like formats and spreadsheet data in the XLSX format. Our approach uses TMRL, KBDS, TabbyXL and OWL converter prototype (TabbyOWL). OWL is considered as a target format for ODPs and domain ontologies.

The current research status involves the implementation and testing our approach on the stage of conceptual model transformations. In particular, content ODPs generation tasks were tested for transformation of UML class diagrams [43], fault trees [44] and fishbone diagrams [45]. In the future, we plan to test our approach on the stage of analysis and transformation of spreadsheets for filling the obtained ODPs by specific values (data).

## REFERENCES

- [1] R.R. Starr and J.M.P. de Oliveira, "Concept maps as the first step in an ontology construction method", *Information Systems*, vol. 38, no. 5, 2013, pp. 771–783. doi:10.1016/j.is.2012.05.010.
- [2] T.A. Gavrilova and I.A. Leshcheva, "Ontology design and individual cognitive peculiarities: A pilot study", *Expert Systems with Applications*, vol. 42, no. 8, 2015, pp. 3883–3892. doi:10.1016/j.eswa.2015.01.008.
- [3] M. Herrero-Zazo, I. Segura-Bedmar and P. Martínez, "Conceptual models of drug-drug interactions: A summary of recent efforts",

- Knowledge-Based Systems, vol. 114, 2016, pp. 99–107. doi:10.1016/j.knsys.2016.10.006.
- [4] J.D. Novak, *Learning, Creating, and Using Knowledge: Concept Maps as Facilitative Tools in Schools and Corporations*, 2nd ed., Routledge, 2009, 336 p.
- [5] P. Hitzler, A. Gangemi, K. Janowicz, A.A. Krisnadhi and V. Presutti, *Ontology Engineering with Ontology Design Patterns: Foundations and Applications. Studies on the Semantic Web*, IOS Press/AKA, 2016, 388 p.
- [6] N.O. Dorodnykh and A.Yu. Yurin, "A domain-specific language for transformation models", *CEUR Workshop Proceedings. Information Technologies: Algorithms, Models, Systems (ITAMS'18)*, vol. 2221, 2018, pp. 70–75.
- [7] N.O. Dorodnykh, "Web-based software for automating development of knowledge bases on the basis of transformation of conceptual models", *Open Semantic Technologies for Intelligent Systems*, vol. 8, 2017, pp. 77–81.
- [8] A.R.D. Silva, "Model-driven engineering: A survey supported by the unified conceptual model", *Computer Languages, Systems & Structures*, vol. 43, 2015, pp. 139–155. doi:10.1016/j.cl.2015.06.001.
- [9] K. Czarniecki and S. Helsén, "Feature-based survey of model transformation approaches", *IBM Systems Journal*, vol. 45, no. 3, 2006, pp. 621–645. doi:10.1147/sj.453.0621.
- [10] T. Mens and P.V. Gorp, "A Taxonomy of Model Transformations", *Electronic Notes in Theoretical Computer Science*, vol. 152, 2006, pp. 125–142. doi:10.1016/j.entcs.2005.10.021.
- [11] Query/View/Transformation (QVT) Version 1.3, OMG Document formal/2016-06-03. Available at: <http://www.omg.org/spec/QVT/1.3/> (accessed September 10, 2019).
- [12] F. Jouault, F. Allilaire, J. Bézivin and I. Kurtev, "ATL: A model transformation tool", *Science of Computer Programming*, vol. 72, no. 1, 2008, pp. 31–39. doi:10.1016/j.scico.2007.08.002.
- [13] D. Varro and A. Balogh, "The model transformation language of the VIATRA2 framework", *Science of Computer Programming*, vol. 63, no. 3, 2007, pp. 214–234. doi:10.1016/j.scico.2007.05.004.
- [14] D. Balasubramanian, A. Narayanan, C. Buskirk and G. Karsai, "The graph rewriting and transformation language: GReAT", *Electronic Communications of the EASST*, vol. 1, 2006, pp. 1–8. doi:10.14279/tuj.eceasst.1.89.82.
- [15] ODP. Available at: <http://ontologydesignpatterns.org/wiki/ODPA> (accessed September 10, 2019).
- [16] E. Blomqvist, *Semi-automatic ontology construction based on patterns*. PhD Thesis. Linköping Studies in Science and Technology, 2009, 349 p.
- [17] C. Masolo, S. Borgo, A. Gangemi, N. Guarino and A. Oltramari, *WonderWeb Deliverable D18: The WonderWeb Library of Foundational Ontologies*, WonderWeb Project, 2004, 349 p.
- [18] A. Gangemi and V. Chaudhri, "Representing the Component Library into Ontology Design Patterns", *Proceedings of the 2009 International Conference on Ontology Patterns (WOP'09)*, vol. 516, 2009, pp. 53–67. doi:10.1.1.211.7677.
- [19] E. Blomqvist, "Ontology patterns: Typology and experiences from design pattern development", *Proceedings of the Swedish AI Society Workshop*, Uppsala, 2010, pp. 55–64.
- [20] M. Milanović, D. Gašević, A. Giurca, G. Wagner and V. Devedžić, "Bridging concrete and abstract syntaxes in model-driven engineering: a case of rule languages", *Software: Practice and Experience*, vol. 39, no. 16, 2009, pp. 1313–1346. doi:10.1002/spe.938.
- [21] J. Zedlitz and N. Luttenberger, "Conceptual Modelling in UML and OWL-2", *International Journal on Advances in Software*, vol. 7, no. 1, 2014, pp. 182–196. doi:10.1.1.682.4807.
- [22] F.S. Parreiras and S. Staab, "Using ontologies with UML class-based modeling: The TwoUse approach", *Data & Knowledge Engineering*, vol. 69, no. 11, 2010, pp. 1194–1207. doi:10.1016/j.datak.2010.07.009.

- [23] A. Belghiat and M. Bourahla, "An Approach based AToM3 for the Generation of OWL Ontologies from UML Diagrams", *International Journal of Computer Applications*, vol. 41, no. 3, 2012, pp. 41–48. doi:10.5120/5525-7566.
- [24] Z. Xu, Y. Ni, W. He, L. Lin and Q. Yan, "Automatic extraction of OWL ontologies from UML class diagrams: a semantics-preserving approach", *World Wide Web*, vol. 15, no. 5, 2012, pp. 517–545. doi:10.1007/978-3-642-10583-8\_16.
- [25] A. Simón, L. Ceccaroni and A. Rosete, "Generation of OWL Ontologies from Concept Maps in Shallow Domains", *Proceedings of the Current Topics in Artificial Intelligence (CAEPIA'07), Lecture Notes in Computer Science*, vol. 4788, 2007, pp. 259–267. doi:10.1007/978-3-540-75271-4\_2.
- [26] I. Myroshnichenko and M.C. Murphy, "Mapping ER Schemas to OWL Ontologies", *Proceedings of the 2009 IEEE International Conference on Semantic Computing*, 2009, pp. 324–329.
- [27] E. Reynares, M.L. Caliusco and M.R. Galli, "A set of ontology design patterns for reengineering SBVR statements into OWL/SWRL ontologies", *Expert Systems with Applications*, vol. 42, no. 5, 2015, pp. 2680–2690. doi:10.1016/j.eswa.2014.11.012.
- [28] T. Rodrigues, P. Rosa and J. Cardoso, "Moving from syntactic to semantic organizations using JXML2OWL", *Computers in Industry*, vol. 59, no. 8, 2008, pp. 808–819. doi:10.1016/j.compind.2008.06.002.
- [29] M.J. O'Connor, and A.K. Das, "Acquiring OWL Ontologies from XML Documents", *Proceedings of the 6th International Conference on Knowledge Capture (K-CAP'11)*, 2011, pp. 17–24.
- [30] I. Bedini, C. Matheus, P.F. Patel-Schneider, A. Boran and B. Nguyen, "Transforming XML Schema to OWL Using Patterns", *Proceedings of the 2011 IEEE Fifth International Conference on Semantic Computing*, 2011, pp. 102–109.
- [31] L. Han, T. Finin, C. Parr, J. Sachs and A. Joshi, "RDF123: From Spreadsheets to RDF", *Proceedings of the 7th International Semantic Web Conference (ISWC)*, 2008, pp. 451–466. doi:10.1007/978-3-540-88564-1\_29.
- [32] T. Lebo and G. Williams, "Converting governmental datasets into Linked Data", *Proceedings of the 6th International Conference on Semantic Systems*, 2010, pp. 1–3. doi:10.1145/1839707.1839755.
- [33] F. Scharffe, G. Atezing, R. Troncy, F. Gandon, S. Villata, B. Bucher, F. Hamdi, L. Bihanic, G. Képéklian, F. Cotton, J. Euzenat, Z. Fan, P.Y. Vandenbussche and B. Vatant, "Enabling Linked Data publication with the Datalift platform", *Proceedings of the AAAI workshop on semantic cities*, In 26th Conference on Artificial Intelligence, W10: Semantic Cities, 2012, pp. 25–30.
- [34] X. Zhang, R. Di and X. Feng, "Ontology Based Data Conversion from Spreadsheet to OWL", *Proceedings of the 2012 Seventh ChinaGrid Annual Conference*, 2012, pp. 76–79. doi:10.1109/ChinaGrid.2012.17.
- [35] K. Tahar, M. Schaaf, F. Jahn, C. Kücherer, B. Paech, H. Herre and A. Winter, "An Approach to Support Collaborative Ontology Construction", *Studies in health technology and informatics*, vol. 228, 2016, pp. 369–373.
- [36] A. Langegger and W. Woß, "XLWrap - Querying and Integrating Arbitrary Spreadsheets with SPARQL", *Proceedings of the 8th International Semantic Web Conference (ISWC)*, 2009, pp. 359–374. doi:10.1007/978-3-642-04930-9\_23.
- [37] M.J. O'Connor, C. Halaschek-Wiener and M.A. Musen, "Mapping Master: A Flexible Approach for Mapping Spreadsheets to OWL", *Proceedings of the 9th International Semantic Web Conference (ISWC)*, 2010, pp. 194–208. doi:10.1007/978-3-642-17749-1\_13.
- [38] A. Dimou, M.V. Sande, P. Colpaert, R. Verborgh, E. Mannens and R.V.D. Walle, "RML: a generic language for integrated RDF mappings of heterogeneous data", *Proceedings of the Workshop on Linked Data on the Web*, Co-located with the 23rd International World Wide Web Conference, 2014, pp. 1–5.
- [39] A.O. Shigarov, V.V. Khristyuk, V.V. Paramonov, A.Y. Yurin and N.O. Dorodnykh, "Toward framework for development of spreadsheet data extraction systems", *CEUR Workshop Proceedings. Information Technologies: Algorithms, Models, Systems (ITAMS 2018)*, vol.2221, 2018, pp.90-96.
- [40] A.O. Shigarov and A.A. Mikhailov, "Rule-based spreadsheet data transformation from arbitrary to relational tables", *Information Systems*, vol. 71, 2017, pp. 123–136. doi:10.1016/j.is.2017.08.004.
- [41] Y.A. Tijerino, D.W. Embley, D.W. Lonsdale, Y. Ding and G. Nagy, "Towards Ontology Generation from Tables", *World Wide Web: Internet and Web Information Systems*, vol. 8, no. 8, 2005, pp. 261–285. doi:10.1007/s11280-005-0360-8.
- [42] A.Yu. Yurin, N.O. Dorodnykh, O.A. Nikolaychuk, A.F. Berman and A.I. Pavlov, *ISI models, mendeley data*, v1, 2019. Available at: <http://dx.doi.org/10.17632/f9h2t766tk.1> (accessed September 10, 2019).
- [43] A.Yu. Yurin, N.O. Dorodnykh, O.A. Nikolaychuk and M.A. Grishenko, "Designing rule-based expert systems with the aid of the model-driven development approach", *Expert Systems*. Vol. 35, no. 5, 2018, pp. 1–23. doi:10.1111/exsy.12291.
- [44] A.F. Berman, N.O. Dorodnykh, O.A. Nikolaychuk and A.Yu. Yurin, "Knowledge bases engineering on the basis of fault trees analysis", *CEUR Workshop Proceedings. Information Technologies: Algorithms, Models, Systems (ITAMS'18)*, vol. 2221, 2018, pp. 25–31.
- [45] A.F. Berman, N.O. Dorodnykh, O.A. Nikolaychuk, N.Y. Pavlov and A.Yu. Yurin, "Fishbone Diagrams for the Development of Knowledge Bases", *Proceedings of the 41st International Convention on Information and Communication Technology, Electronics and Microelectronics (MIPRO-2018)*, 2018, pp. 967–972. doi:10.23919/MIPRO.2018.8400177.

# Constructing Fault-Tolerant Autonomous Systems with Detection of Failure Causes

V.N. Dianov\*, A.S. Dorofeev\*\*, R.S. Dorofeev\*\* and E.A. Cherkashin\*\*,\*\*

\*Moscow state technical university, Moscow, Russia

\*\*National research Irkutsk state technical University, Irkutsk, Russia

\*\*\*Matrosov Institute for System Dynamics and Control Theory of Siberian Branch  
of Russian Academy of Sciences, Irkutsk, Russia

vyacheslav-dianov@yandex.ru, dorbaik@istu.edu, rdobermann@list.ru, eugeneai@irnok.net

**Abstract - The problems of constructing fault-tolerant equipment currently in demand in various fields of Russian economy development and defense technology, particularly with regard to the introduction of robotics and artificial intelligence in various stages of production and operation with high requirements for reliability and security. In the article, a technique for development and operation of modern fault-tolerant automation systems with the presence of hidden defects are considered.**

The conceptual features of malfunction-free operation of equipment are rather well known. At the same time, the proposed concept of increasing the reliability and safety of the equipment is based on detection and registration of the sources (e.g., hidden defects) of failures but not their consequences. New concepts introduced such as differential failure, integral failure, integral-differential failure, failure lifetime, residual life of equipment in case of failure, intelligent tolerance. The methods and tools for fault-tolerant operation of the equipment at the various informative precursors and criteria are presented. The proposed differential method allows one to fix the source of the failure in the passive components of electronic equipment.

An example of the tolerance of optoelectronic complex of space control, which is a component of a system of space monitoring and is intended for operational information about the space situation, cataloging space objects of artificial and natural origin is considered. Informative parameter of the intelligent tolerance here is the optical wavelength range.

## I. INTRODUCTION

One of the most important indicators of the quality of the technical system or object is their reliability. Fault-tolerance is a kind of the "reliability" notion. It is defined as the capacity of equipment being continuously keeping working during some time period. The work is devoted to intelligent failure tolerance of electronic equipment (EA) of modern automation systems.

Let us highlight the main shortcomings of the existing methods of eliminating the impact of failures on the equipment.

- Currently about 15 kinds of failure are known; this category of faults is constantly broadening, so in each case the concrete specification is needed, which is usually absent in analysis;
- It is unclear, what stages equipment passes from a correct state to a malfunction due to a failure;
- It is unclear, how to use the residual resource and lifetime of the equipment after the failure;
- The occurrences of failures are considered to have probabilistic rather than deterministic nature, as a result, passive methods of fault diagnosis and control are widely used;
- Only malfunctions of active elements (transistors, chips) are analyzed, and the issues of detecting and recording failures in the passive elements such as contact paths of printed circuit boards, contact devices, LSI and VLSI, power rails, shielding conductors, and connectors are completely left aside.

We, therefore, propose to supplement the term basis of the existing equipment reliability and fault-tolerance of the equipment with the concepts of "malfunction-free" and "intelligent tolerance". Questions of construction of malfunction-free operation of the equipment in aviation, aerospace, machine building, instrument making and other important areas of development of the national economy and defense technology are very popular, especially with the introduction of robotics and intelligence in various stages of production and operation, as well as with the increased requirements for reliability and security. Life cycle control should be carried out on the base of information about the precursors of malfunctions, which are usually failures.

## II. METHODOLOGY

In Russia, one of the classic ways to solve these issues related to ensuring fault-tolerance and followed malfunction-free regimes described in [1]. The conceptual features of malfunction-free operation of the equipment are rather well known [2]. The principal difference of the



proposed concept to improve reliability and safety of the equipment, in particular, by identifying the hidden defects and eliminating their effects on it, is that the sources of failures are detected and recorded, instead their impacts [3]. In other words, the cause (not the consequence) is figured out, and thus we transit from passive methods of failure protection to active ones. One of the informative parameters is “electromagnetic radiation”. The reliability and functional safety of electrical, electronic and programmable electronic systems are related to failures and malfunctions [4]. Hidden defects in the form of connections (micro-breaks, micro-cracks, partial breaks in the communication lines, the breaking of contacts of the contacting devices) as the main sources of failures form micro-resonance contour with the increased electromagnetic radiation. Therefore, it is electromagnetic radiation in the frequency range 2-4 GHz can be considered as an informative parameter; it can be registered with contactless failure sensors built using the principle of reversibility of antennas [5]. To improve the reliability of control in failure detection with external electromagnetic interference with contactless sensors contact ones can be used. Their simultaneous actuation allows us to diagnose failures as a consequence of latent defects in equipment. Actuation of only contactless failure sensor implies identification external electromagnetic interference.

### III. RESULTS AND DISCUSSION

In Figure 1 a testing connection with the failure mode in the off state is shown.

The distance between the emitter (connector 1) and the receiver (connector 2) varied from a few millimeters to 40-50 cm. In particular, curves 1 and 2 obtained for the distance between connectors 10-12 mm. Connector 2 selected according to “on” mode failures in order to obtain maximum sensitivity when receiving signals. With the respect of the above, in the theory of failures, especially in the theory of reliability and security, the concepts of “differential failure”, “integral failure”, “integral-differential failure”, and “intelligent tolerance” are introduced.

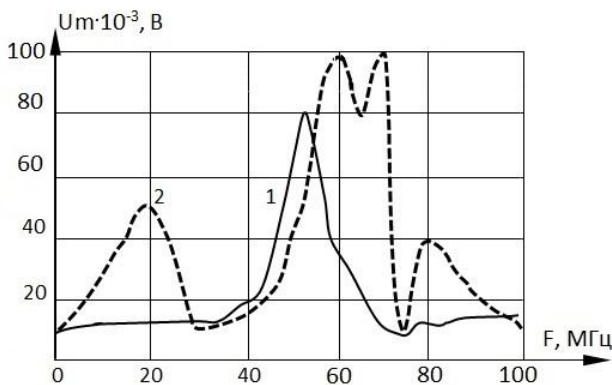

Figure 1. Contactless testing a failure in “off” mode: 1 is the emitter, 2 is the receiver

The proposed differential method allows us to fix the source of the failure in passive components EA such as communication lines, interface and ground buses, power

and grounding connectors, bus management. All the above elements, having existing hidden defects or acquired ones in the process of exploitation in the form of micro-cracks, micro-sation, partial breaks, and poor contacts in the connectors were supplemented with electrical circuits with micro-capacitors.

The subsequent high ohm input resistance of the load, *e.g.*, tens of mega-ohms of CMOS circuits, together with formed micro-capacitance of the defect gives raises the preconditions for a differentiation of the useful signals passing through this circuit, and, therefore, registration of a latent defect in the form of a failure. This, in turn, allowed us to capture the initial stage of an element failure (early failure). On the other hand, in the process of further destruction of the element at the point of the detected failure source, its electrical resistance is increasing in tens and hundreds of times. For example, the connector used in good and active condition has the resistance of 20-30 micro-ohm. In the failed state (in particular, before the destruction), this resistance increases to several hundred Ohms. Adding a micro-capacitance in parallel to the CMOS load, we will have an integrating circuit as a result. This circuit can be used as a precursor of an element failure in its intermediate state, that is, after fixing the differential failure and until fixing an integral failure.

The state of a latent defect can be diagnosed using, for example, code-impulse modulation of signals. Thus, introducing the concept of “differential failure” and “integral failure”, we have the opportunity to obtain a more detailed description (the beginning and the end stages) of the same failure. Combining these concepts into one, *i.e.*, into “integral-differential failure”, we can talk about survivability margin of an element in the failed state, or a lifetime of a failure. In turn, the assessment of the parameter “lifetime of a failure” allows us to uniquely determine the important parameter of a system as “residual resource”.

Applying it to a logic element of a combinational circuit, it is necessary to note that its state change from healthy one to a state of a precursor of a failure occurs according to the exponential law with a particular constant. Naturally, the transition of the element state from “0” to “1” will be not instantaneous, but in a finite time, *i.e.*, the rise time is finite ( $\tau_{fr} \neq 0$ ).

Using a known formula, it is possible to link the parameter “rise time” from the upper boundary frequency of failure  $f_{gr}$  ( $\tau_{fr} \approx 0.35f_{gr}$ ). According to the obtained upper boundary, frequency of this differential failure can be fixed contactless, using the informative parameter “electromagnetic radiation”. The working principle of the contactless sensor of a failure has been proposed earlier in [6].

The state of integral failure occurring after a differential failure state will correspond to a lower frequency, accounting the increase in the duration of the front of the impulse. The range of duration variation of the fronts of the differential failure to integral one could be determined either experimentally (before operation), or by modeling failed states, regarding the impact of different data time lag of the test element. Original construction

order for sensor of integral-differential failures, configured, for example, on two frequencies (upper and lower), which correspond to differential and integral failures of the element is presented in [7, 8].

It should be noted that the detection and registration of failures by the differential and integral precursors, as well as fixing intermediate symptoms, are associated with the intelligent processing of failure signals detected thanks to informative properties in the passive elements. In particular, in the failing state of elements, a number of informative signs had been registered, which are different from above mentioned states of the elements such as “correct” and “failure”. Identifications of these states are carried out thanks to an original code-impulse signal processing, in particular, with their simultaneous processing in the time and frequency domains.

Experimental studies confirmed this assumption made *a priori*, this resulted in registering all achievements as discovery with issuing the respective documents by Russian Academy of Natural Sciences [9]. Detection and registration of a differential failure indicating the appearance or existence of a latent defect was implemented in autonomous sensors [7]. Recognition and registration of an integral failure fixing the upcoming transition of an element from a failed state to the malfunction was first obtained in flow-meters sensors [10]. Detection and registration of an integrant-differential failure that designate the lifetime of a failure have been proposed in the diagnosis of single and multilayer printed circuit boards [11]. Issues of discovery and registration of differential and integral failures, as well as the majority of the signal processing of internal and external interference, are resolved in parking systems of high reliability [12].

As an example, consider the fault-tolerance of optoelectronic complex of space control [13]. The complex is a component of the system of space control and is intended for operational acquisition of information about the space environment. The complex is cataloging space objects of artificial origins, determining their class, destination, and current status. It allows one to detect any space objects at altitudes from 2000 to 40000 km, including geostationary orbits, as well as automatic detection, recognition, and computation of orbits of space objects larger than one meter. The complex is able to serve even low-orbit space objects with altitudes from 120 to 2000 km.

The principle of operation is based on passive location of space objects by the reflected sunlight. Direct observation of the space takes place at night in automatic mode. In one “night” session, complex provides information about all known and newly discovered space objects. In addition, any spacecraft, put into an orbit from any launch site in the distance more than 2000 km, falls into the zone of action of the complex for several turns.

We consider technique of the failure tolerance of the complex in optical and electromagnetic wave ranges. The technique is intended for television (TV) devices (optical range), which is usually a part of the station.

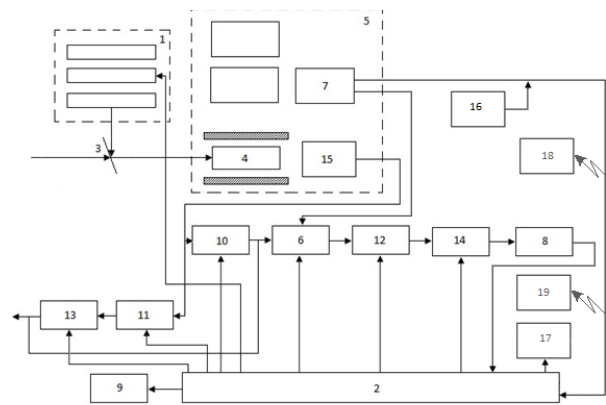

Figure2. Structural diagram of a television control based on code-impulse signal modulation and failure sensors

The proposal relates to TV equipment and can be used to automatically control the operation of transmitting TV systems. A device for controlling the operation of the TV transmitting camera is proposed in [14]. However, this device has low control accuracy, in particular, due to the lack of registration of precursors of failures or malfunctions. The aim of the proposal is to improve control accuracy with the failure detection and elimination of the resulting malfunctions.

Device for controlling the operation of the TV transmitting camera (see Figure 2) contains the projector 1 with the test table, whose input is connected with the an output of the computing unit 2 via a translucent mirror 3. The mirror is optically adjusted with a target of the TV transmitting tube 4 of the TV transmitting camera 5. Unit 6 of line selection, whose first input is coupled to one of the outputs of the sync signal generator 7 of the TV transmitting camera 5 and the second input with the corresponding output of the computing unit 2. Computing unit inputs are connected to the output of the voltage-code converter 8 and sync generator output 7 of the TV transmitting camera 5. Information display unit 9 connected with an output of the computing unit 2.

Two switches 10 and 11, two elements “and” 12 and 13, and optimum filter are introduced. The output of the video amplifier 15 of the television transmitting camera 5 is connected with the inputs of the switches 10 and 11. Their inputs are connected to the computing unit 2. The output of the first switch 10 is connected to the third input of the unit 6 of line selection, whose output is serially connected with the “and” element 12 and optimum filter 14. Optimum filter inputs are connected with the inputs of the computing unit 2, as well as to the input of the voltage-code converter 8. The output of the second switch 11 is connected to the first input of the second “and” element 13, whose second input is connected with an output of the computing unit 2. The output of the second “and” element 13 is connected with the third input unit 6 of line selection [15]. Moreover, a contact 16, 17 and contactless 18, 19 sensors are introduced in the device.

The device operates as follows. Through the translucent mirror 3, the projector 1 projects a test table of control. Test table consists of a group of lines located on the edges. The table is projected to the target of the

television transmitting tube 4, occupying its peripheral part. Thus, the operation of the TV signal for obtaining information about the functional state of the TV signal is performed continuously in parallel without influence on each other.

From output of the first switch 10, the TV signal is supplied to the third input of the unit 6 of line selection. Its second input receives the sync impulses from sync impulse generator 7 of the TV transmitting camera 5. Its first input receives control pulses from the computer 2. The output signal of the unit 6 of line selection contains information about the strokes of control test table. The TV signal of one line is group harmonic vibrations at the frequency  $w(t)$  corresponding to the spatial frequency  $w(x)$  of the optical image in section of the raster line. From the output unit 6 of line selection of the TV, signal is transmitted to the input of the first element "and" 12, whose second input is supplied an "enable" impulse with the duration  $t_1$  from computer 2. As a result, in the intervals between group vibrations  $t_2$ , the TV signal is zero, which ensures high immunity to interference of the unit, as a complete noise suppression is performed in intervals  $t_2$ .

From the output of the first element "and" 12, the TV signal is transmitted to the optimum filter 14, whose purpose is the analysis and determination of frequency of oscillation  $w(t)$ , the suppression of the interference in the interval  $t_1$  and the output of potential (voltage) proportional to the frequency  $w(t)$  to the input of the voltage-code converter 8. Transfer ratio of the frequency characteristic of the optimum filter 14 is chosen as a complex-conjugate to frequency spectrum of the TV signal, ensuring optimal receiving. The gating pulses to the second input of the optimum filter 14 are served by computer 2. From the output of voltage-code converter 8, code series of impulses corresponding to the frequency  $w(t)$ , are transmitted to computer 2, which compares the input series with a reference ones and performs control of the state of the TV signal.

To provide high frequency spatial measurements of the TV signal, a periodic calibration is performed on the target of the TV transmitting tube 4 by the projector 1 with projecting the test table. When calibrating the TV signal, the calibration test is projected to the center part of the target of the TV transmitting tube 4 at a time of 3-6 frames. This operation is used for additional control of the TV signal, increasing its noise immunity. At the time of the calibration, the computer 2 sends a command to the projector 1 with the test table to replace the test. To the input of the second element "and" 13, an "enable" pulse is received. Simultaneously, TV signal is transmitted from the second output of the second element "and" 13 to the input unit 6 of line selection for the selection of five lines. From the output of unit 6 of line selection, the television signal that contains information about all groups of strokes of the control and calibration tests is received. Because of the short duration of the projection on the target of the TV transmitting tube 4 for calibration test TV video signal is not disturbed.

Thus, this device allows us to continuously control of correctness of communication of spatial frequencies of an optical image.

The causes of failures in the electromagnetic wave range of modern complexes can be both various external influences (vibrations, power electric fields, temperature and chemical effects), as well as numerous hidden hardware defects connected with them. The appearance of new properties of passive elements in a narrow (boundary) layer of their intermediate state between "serviceable" and "faulty", in particular, such as signal differentiation and integration, allows us to solve the problem of the failure durations arising from latent defects. For this purpose, contact 16, 17 and contactless 18, 19 (hybrid) sensors of faults are introduced into the equipment, which are triggered by informative signs of "differentiation" and "integration" of signals, as well as "electromagnetic radiation" that implement the hybrid diagnostic methods for hidden defects.

Improving the reliability and quality of operation is ensured by the detection and registration of internal and external electromagnetic interference. In this case, both distributed and local sources of failures are detected and recorded. The effect is achieved both by the introduction of contact and contactless failure sensors, and by signal processing algorithms from these sensors. As informative parameters, changes in the amplitude-frequency characteristics, increased electromagnetic radiation, the appearance of the effect of differentiation and integration of signals are used.

To determine the failed states and sources of failures of communication lines and connectors according to the aforementioned signs, latent defects are presented in the form of micro-gaps, micro-roughnesses, micro-cracks, partial micro-cracks and, as a result, formation of micro-capacities and micro-resonant circuits. Figure 2 shows an application of contact fault sensors (CFS) 16, 17 and contactless fault sensors (CIFS) 18, 19. In general, this number can be large, depending on the specific communication line and the size of its discretization at points, where a failure fix is needed.

For simplicity, only a separate connection of element 7 with block 2 is selected (Figure 2). In the general case, sensors can be installed on each communication line of elements, nodes and blocks, as well as to the connection points of various contacting devices and connectors. Both CDS and CIDS can have both autonomous and centralized (for example, using block 2) control. Failure sensors work on-line in parallel with the operation of nodes 5-15, monitoring the passive elements of the equipment mentioned above for the presence of latent defects, manifested in the form of a failure in or the presence of internal and external electromagnetic interference. At the same time, the simultaneous operation of the CIDS in various sections (communication lines) and the non-operation of the BDS indicate a source of failures in the form of external electromagnetic interference. The simultaneous operation of the CDS and CIDS captures the internal electromagnetic interference. For the first time, failure sensors were presented at the International Aviation and Space Salon (MAKS-94) in Moscow in the

Radio Industry pavilion on Krasnaya Presnya. In some cases, for example, the detection of latent defects in the form of short-circuited turns in actuators, e.g., electric motors, it is more advisable to use the offline mode [2]. One of the promising areas is the automotive industry [16].

Usage of the above mentioned methods and devices gives the best effect when TV measurement systems are combined with computers. In this case, control of the TV signal is performed without additional complex devices. Improving the accuracy of control due to registration of failures as precursors of malfunctions allows us to construct the equipment to be fault-tolerant, to prevent malfunction of the controlled system and thereby enhance its reliability. The increase in the noise immunity due to the discrete nature of the signal processing in the device for controlling the operation of the TV camera extends the range of applications compared with other similar devices.

#### IV. CONCLUSION

Detection and registration of an integral-differential failure that designate the lifetime of a failure have been proposed in the diagnosis of single and multilayer printed circuit boards [11]. Issues of discovery and registration of differential and integral failures, as well as the majority of the signal processing of internal and external interference, are resolved in parking systems of high reliability [12].

In this regard, the existing classification methods for the detection and registration of sources of failures is complemented by the integral-differential method and by a majority of the failure processing of the signals allowing to rise the intelligence level of the process of failure diagnosis in a new level.

It should be recognized that the construction of an intelligent fault-tolerant control systems in modern electric power industry is especially promising [13]. In this regard, the existing classification methods for the detection and registration of sources of failures is complemented by the integral-differential method and by a majority of the failure processing of the signals allowing to rise the intelligence level of the process of failure diagnosis in a new phase.

#### REFERENCES

- [1] V.N. Dianov. Reliability, diagnostics, failure tolerance of automated systems. Monograph. – Cheboksary: "New era", 2018. 812 S. (in Russian)
- [2] V.N. Dianov. Conceptual characteristic features of fault-free hardware design. Automation and remote control. 2012, Vol. 73, No. 7. PP. 1202–1215.
- [3] V.N. Dianov. Diagnosis of latent defects of robotic systems. A. Ghevondyan, S. G. Duseyev // Proceedings of higher educational institutions. Povolzhskiy region. Technical Sciences. 2013. No 3 (27). P. 189-198. (in Russian)
- [4] The IEC 61508 Functional Safety of Electrical/Electronic/Programmable Electronic Safety Related Systems.
- [5] Dianov V. N. Active diagnostics of the failures in printed circuit boards. EMS-Zurich in Singapore, Suntec Singapore international Convention & Exhibition Center, IEEE. Singapore, 2006, p. 4.
- [6] V.N. Dianov, B.D. Tsarev, B.E. Policer, et al. Sensor of electric signals. Patent of Russia, invention No 2064189. 1996. (in Russian)
- [7] V.N. Dianov, A.A. Sarkisov, D.V. Vlasov. A method and apparatus for intelligent fault diagnosis of automotive sensors. Patent of Russia, invention No 2292578. 2007. Bull. No. 3. (in Russian)
- [8] V.N. Dianov. Integro-differential code-impuls modulation in the diagnostics of latent defects of complex objects. International Scientific – Practical Conference “Innovative Information Technologies” (I2T). Prague. 2012, April 23 – 27. P. 403 – 405. (in Russian)
- [9] V.N. Dianov, N.A. Severtsev, Yu.G. Evtushenko. Property of passive electronics elements to increase the amount of acquired information on a system under the influence of electric oscillations. Scientific discovery in the field of reliability theory, the theory of security (diploma 47 – s). The scientific discoveries of 2012. A collection of short descriptions of scientific discoveries, scientific ideas. Academy of Natural Sciences. (in Russian)
- [10] V.N. Dianov, A.A. Chernyaev, K.V. Plushkin, et al. Method and apparatus to detect sources of faults in sensors-flowmeters. Patent of Russia, invention No 2296952. Priority of invention of February 28, 2005. (in Russian)
- [11] V.N. Dianov, A.V. Puzanov, M.N. Mironov, et al. Equipment for testing printed circuit boards with detection of hidden defects. Patent of Russia, useful model No 91767. 2010. Bull. No. 6. (in Russian)
- [12] V.N. Dianov, T.A. Ghevondyan, I.M. Belousov, et al. Parking system. Patent of Russia, useful model No. 141562. 2014. Bull. No. 16. (in Russian)
- [13] Wikipedia the free encyclopedia, article “Optical communication” [Electronic resource]. URL: [https://en.wikipedia.org/wiki/Optical\\_communication](https://en.wikipedia.org/wiki/Optical_communication)(date accessed: 20.08.2019).
- [14] Ya.A. Riftin. The quality of the TV transmission. The technique of film and television. 1963, No. 6. (in Russian)
- [15] K.A. Shabelnitsky, V.N. Dianov, V.S. Chernov, et al. A device for controlling of a television camera. Patent of Russia, useful model No 621129, published at 25.08.1978. Bull. No 31. (in Russian)
- [16] V.N. Dianov, Intelligent fault-tolerance of automotive electronic systems. International Automotive Science Forum (IASF-2019). Moscow, NAMI, October 16-18, 2019. (in Russian)

# Development of a Tool for Visualization and Analysis of 1C:Enterprise Configurations

V.V. Kopylova\*, S.S. Ipantieva\*\* and E.A. Cherkashin\* \*\*\*

\* Irkutsk National Research Technical University, Irkutsk, Russia

\*\* CJSC "CROC" Irkutsk, Russia

\*\*\* V.M. Matrosov's Institute of system dynamics and control theory SB RAS, Irkutsk, Russia  
kopylovika@mail.ru, saint.esp@gmail.com, eugeneai@icc.ru

**Abstract** - The article discusses the automation of a structural analysis and visualization of configurations of commercial CRM software 1C: Enterprise. General scheme of the analysis and visualizing the results is based on a hierarchical clustering of configuration objects and UML class diagram representation. The software structure analysis tools allow developer to reduce time for understanding complex configurations. Examples of application and interpretation of the results are also presented.

**Keywords:** hierarchical cluster analysis, 1C:Enterprise, configuration structure, source code parsing, source code generation, configuration analysis tool.

## I. INTRODUCTION

ERP software of Russian vendor 1C in 2017 had 31% [1]. Mostly small and medium sized companies use it. 1C applications solving a particular problem are referred to as solutions, which are configuration objects for the common interpreting platform. Companies that use 1C software have two options: either modify the software to reflect their business processes or reorganize their selves according to the standard configurations.

During its existence of the 1C platform, the number of functioning copies of configurations is constantly increasing. Russian legislation is also being improved, which requires rapid improvement of each copy of the product. Automation of enterprises, in general, requires improvements to the overall solution, making it more individual. All this contributes to the increase of objects in the configuration, which can lead to duplication of functions of some objects in others, up to full functional equivalents. Configurations consist of objects of various species: document structure descriptions, vocabularies (catalogs), indexes, reports, so called routines, etc. For each catalog and document configuration tool creates a rational table with all necessary many-to-one relations. Object structure of the catalogs and documents contains no inheritance relationships; moreover, there are no instruments to create ones. Thus, usually, the catalogs and documents have redundant structures. Implementation of an automatic analysis of the configuration on the similarity of objects allows programmer to identify duplicate objects.

From the other hand side, the prevalence of the 1C on the market of small and middle sized companies says that the configurations contain actual knowledge on structures and algorithms of data storage and processing for the

standard way of common business process operations. These knowledge could be translated (transpiled) to another programming environment, e.g., for better integration with existing software.

Development of 1C software organized in a hierarchical structure [2]. Companies that automate of business processes of enterprises have developed a huge amount of code that implements various aspects of enterprise activity. The company "1C" produces a wide range of application not only for automated accounting, operational and management accounting at enterprises, but also for automation of warehousing, personal management, production management, logistics, etc. The software applications allow one to quickly generate reports, receive data, process a large amount of information. Currently "1C Accounting" application is the most popular enterprise accounting program in Russia, allowing managers to save time, optimize the number of employees engaged in accounting, as well as improve productivity.

Each configuration is a complex data structure that is interpreted within the 1C Technology platform runtime. However, a quick visual comparison of configurations from different 1C applications shows that they are developed absolutely independently of each other. In addition, within one configuration, the object structure is a non-hierarchical list of structures with common properties, which leads to the copying of structural and algorithmic information and, accordingly, makes it difficult to maintain the program code.

The structure of any 1C application configuration includes the interpreter platform, application configuration and enterprise database. Let us consider their difference in details.

*Platform* is the foundation of the system and the configuration development environment. The platform is called 1C: Enterprise. The main purpose of platform is to interpret configurations. The platform is developed by programmers separated from the configuration development.

*Configuration* (so-called "application solution") is a program developed on the 1C Enterprise platform that performs specific accounting tasks of a particular automation sector in a single enterprise. The most widely used configuration is 1C: Accounting.

Configurations have releases or revisions; the release is an update of the configuration, which is associated with

the development of the application solution, the improvement of various functions, as well as changes in current legislation or market requirements. The new version of the configuration does not bring significant changes in the structure of the program from the point of view of the code.

*Database* is formed by the information that users enter into the system using the user interface provided by the configuration, and is stored, processed, corrected, deleted, etc.

Platform cannot perform any user tasks, as it is designed to provide configuration interpretation and perform a number of other functions. In addition, a configuration will not work without installing the platform. They only function as a complex system.

Another possibility of using of visualizing procedures and analysis is to support the work of a novice programmer: familiar objects are compared with others, and, to some extent, inductively it is possible to evaluate the properties of unfamiliar objects in a known way. This approach, in our opinion, will improve the productivity of novice programmers.

Although this is not typical of the 1C platform, in most software systems that support objects and object-oriented programming structures (classes) are in mutual relationships to the "inheritance" of properties. In addition, these relations can be represented as a hierarchical structure — N-ary tree. This hierarchy is natural, because professional programmers always try to introduce abstractions if there are two classes of objects that are similar in structure and properties. A common ancestor class is created, where common fields and methods of both classes are placed, thus avoiding duplication in the implementation of these elements. On the other hand, in debugged code, when creating new functions from existing classes, one can create descendant classes, where new functions are already implemented.

*The aim of the study* is to device software tools that allows programmer to analyze configurations, represent them in the form of UML [3] diagrams, compare the structure and properties of various configuration objects, as well as to visualize the results of this comparison.

The objectives of the study include:

1. Create procedure for importing the data structure in the format of XMI;
2. Development of object structure comparison function;
3. Construction of the system clusters using the compare function, the visualization of this structure;
4. Interpretation of the results.

## II. VISUALIZATION OF THE OBJECT STRUCTURE OF 1C: ENTERPRISE CONFIGURATIONS

An UML model is an example of object models used for the design of structures of objects in a form independent from implementation in a particular programming language. UML models are stored in XMI

exchange format that provides practical interoperability when working with editing tools and synthesis software code (CASE systems). In other words, UML models are documents that are used in a variety of ways, from printing images to automatically generating human-readable text descriptions of various systems [4].

### A. The visualization tool

The architecture of the tools is a set of connected functional blocks:

- User interface;
- Class for processing an XML document using SAX;
- Class to generate XMI document using the document object model DOM;
- A class that implements the external connection configuration 1C.

User (programmer) loads the metadata structure of 1C configuration in XML format, which has previously been obtained using external processing, part of the delivery 1C Conversion 2.0. Then, the system analyzes the received XML file using SAX parser. The pattern of object creation starts SAXParserFactory SAXParser, which in turn via the ContentHandler interface allows one to get all the elements and attributes contained in a XML file.

Then, based on the received data, using the document object model, DOM file is generated UML model in the XMI format. In addition, programmer can use the external utilities to connect to the 1C configuration to obtain the necessary data in the TXT format. The developed software system is tested on three configurations of 1C, which are the most popular in the small and medium business:

- Retail 2.0 (managed forms, typical configuration),
- Accounting enterprise 2.0 (normal application, typical configuration),
- Management of funeral services 1.5 (managed forms, industry solution).

Test process resulted in the XMI file generated and imported in the Modelio Open Source Environment (<https://www.modelio.org/>), for example a part of Class diagrams for the document "the retail sales Report" shown in Figure 1.

Based on data from SAX-analyzer [5], an UML model was formed in the XMI format. To do this, we use the document object model DOM because DOM is used to parse XML documents and construction with a standard API, unlike the SAX parsers, which are used exclusively for XML parsing.

The document object model DOM represents XML files (and therefore XMI files) as trees of nodes. XML parsers allow us to write the DOM tree in the XMI file and get the DOM tree from the XMI file.

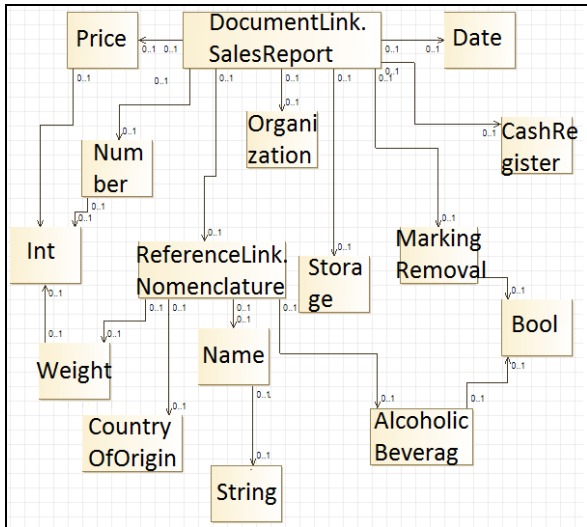

Figure 1. Class diagram for document "Retail sales report"

**B. An object structure analysis technique for IC: Enterprise configurations**

In the analysis, we assume that the objects of IC configuration correspond to some hierarchical structure of inheritance, and these objects are the only instances of these classes. Thus, under the similarity of the two objects, we will further understand the properties of the location of the corresponding classes in this hierarchy. Objects are more similar to each other if there are fewer structural elements (vertices and arcs) between their classes along the path connecting these classes.

The results of hierarchical clustering have a similar property. To build such a clustering, you need to create a two-argument function that produces 0 if both arguments are identical (in particular, the same), and some positive number if the objects do not match, and the more objects "do not match", so this number will be greater. Such a function measures the dissimilarity of two objects.

**C. Hierarchical clustering**

Hierarchical clustering is a set of algorithms organizing data in order to create a tree of nested clusters. There are two classes of hierarchical clustering methods:

- Agglomerative (connecting) methods: new clusters are created by combining smaller clusters and thus the tree is created from leaves to trunk;
- Divisive (separating) methods: new clusters are created by dividing larger clusters into smaller ones and thus the tree is created from trunk to leaves.

In this report, as a measure of the dissimilarity, we will use general characteristics of the structure of the object: the number of fields (or attributes), the number of table parts and the number of fields of these table parts (attributes in tables). These parameters are the three coordinates in the Euclidean object space. Source data about object structures is loaded from XML-file. The dendrogram is constructed by agglomerative method, first combining the most similar objects into sets. Root is the top of the dendrogram is, in fact, is configuration.

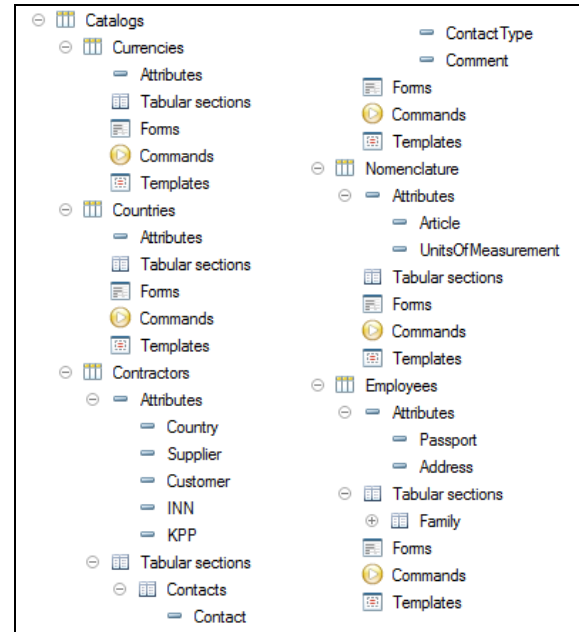

Figure 2. Composition of the test configuration

As an example, consider a simple configuration specifically designed to test the proposed technique. The configuration consists of five directories: Currencies, Countries, Contractors, Nomenclature and Employees (figure 2).

Directories of Currencies and Countries consist of fields "Mark Removal", "Code" and "Name". Details of the directory Nomenclature contains more fields: "Mark Removal", "Code", "Name", "Article" and "Units of measurement". The structure of the directory Contractors and Employees include also a tabular part. Contractors details are "Mark Removal", "Code" "Name", "Country", "Supplier", "Customer", "INN", "KPP"; table part is "Contacts" consisting of details "Contact", "Contact Type", "Comment". Employees comprises details "Mark Removal", "Code" "Name", "Passport" and "Address"; table part is "Family" consisting of details "Role", "Full name".

The reading process of the structures of the objects in the XML configuration file is a sequential tree traversal in depth. In the analysis state, we use a method of processing the source file that integrates DOM with the object properties of the Python — ElementTree. The ElementTree library represents the DOM as language objects [6] rather than as low-level abstract library objects, which greatly simplifies the processing of the original XML data.

Since the purpose of reading the XML configuration document is to collect generalized data about the structure of objects, when the desired element of the structure is found, data about it is recorded in the appropriate table of the local database implemented using the library SQLite 3 [7].

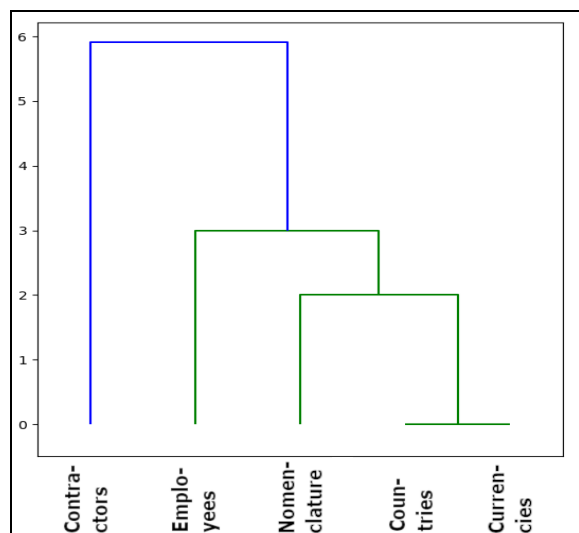

Figure 3. Dendrogram for test example

Recall, that the number of fields, the number of table parts, as well as the number of fields in the table parts, which gives the Euclidean space with three coordinates, characterize each configuration object. For the objects presented in this example, the coordinates are shown in Table 1.

TABLE I. EXAMPLES OF COORDINATES OF OBJECT FEATURES

<i>Reference</i>	<i>Coordinates</i>
Currencies	[3,0,0]
Countries	[3,0,0]
Contractors	[8,1,3]
Nomenclature	[5,0,0]
Employees	[5,1,2]

Example of calculation of the distances between objects are in Table 2, for these distances dendrogram have been built (Figure 3) with clustering.

TABLE II. DISTANCE BETWEEN OBJECTS  
(A MATRIX OF DISSIMILARITIES)

	<b>Currency</b>	<b>Countries</b>	<b>Contractors</b>	<b>Nomenclature</b>	<b>Employees</b>
<b>Currencies</b>	0,0	0,0	5,916	2,0	3,0
<b>Countries</b>	0,0	0,0	5,916	2,0	3,0
<b>Contractors</b>	5,916	5,916	0,0	4,395	3,162
<b>Nomenclature</b>	2,0	2,0	4,395	0,0	2,236
<b>Employees</b>	3,0	3,0	3,162	2,236	0,0

Since all the data on the structure of the objects stored in a database, the structure of the object easily retrievable and can be represented in a formal language.

Reference	Props Comment
ReferenceLink.Currencies	/TablePart
Props MarkingRemoval	/Reference
Props Code	Reference
Props Name	ReferenceLink.
/Reference	Nomenclature
Reference	Props
ReferenceLink.Countries	MarkingRemoval
Props MarkingRemoval	Props Code
Props Code	Props Name
Props Name	Props Article
/Reference	Props
Reference ReferenceLink.	UnitsOfMeasurement
Contractors	/Reference
Props MarkingRemoval	Reference
Props Code	ReferenceLink.
Props Name	Employees
Props Country	Props
Props Supplier	MarkingRemoval
Props Customer	Props Code
Props INN	Props Name
Props KPP	Props Passport
TablePart Contacts	Props Address
Props Contact	TablePart Family
Props ContactType	Props Role
	Props FullName
	/TablePart
	/Reference

Similarly, one can get a representation of the data structure of an object in another object-oriented language, for example in MQL4. MetaQuotes Language 4 (MQL4) is a built-in programming language for trading strategies developed by MetaQuotes Software Corp. based on its many years of experience in the creation of trade and information platforms. This language allows programmer to write Expert Advisors programs that automate the management of trading processes and are ideal for implementing own trading strategies. Besides, using MQL4, one can create your own custom indicators, scripts and libraries.

### III. RESULTS AND DISCUSSION

Consider two identical according to the given dissimilarity function structures of the directories "Currencies" and "Country". They currently contain no fields or table parts. Both directories have standard attributes "Mark Removal", "Code" and "Name". Then one can create a class "Base" and fill it with the last three standard attributes.

```

Class Base {
    protected:
        bool MarkRemoval
        int Code
        string Name
}
    
```

Our directories will be the children of the created Base class.

```

Class Currencies : public Base { }
Class Countries : public Base { }
    
```

Continuing building classes based on inheritance, we get the following code for rest of structural objects.



```
Class Nomenclature : public Base {
    private:
        string Article
        string UnitsOfMeasurement
    }
Class Countries : public Base {
    private:
        string Passport
        string Address
        table Family {
            string Role
            string Name
        }
    }
Class Countries : public Base {
    private:
        Country aCountry
        bool Provider
        bool Customer
        string INN
        string KPP
        table Contacts{
            string Contact
            string TypeContact
            string Comment
        }
    }
}
```

#### IV. CONCLUSION

We developed a software system for the visualization of the configuration structure 1C allows programmer to analyze the metadata structure of 1C configurations by conversion in an UML model in the XMI format. Visualization method discussed in the study implements the international standards for the presentation of configuration objects of an application, in contrast to available on the current market.

In the report, the technique of the generalized analysis of structure of objects of configuration 1C is offered. The technique is based on the construction of a dendrogram with an agglomerative method based on the "similarity" of object structures. The quantitative characteristics of the structure of objects are used as a measure of similarity. An example of the test configuration analysis of five reference objects is given.

Using the developed methodology and tools for analyzing 1C configurations allows one to get a visual representation of the structure of 1C:Enterprise configurations in the form of hierarchies of objects. It is

useful to localize duplication of objects having the same structure, as well as to obtain a program for representing objects in another object-oriented language that supports inheritance of properties.

Future activity of the project should be organized in the following directions:

1. Improvement of the dissimilarity function to optionally account type and names of attributes;
2. Development of a transpiler, a translator of 1C object structure to another high level language;
3. Device a refactoring tool for joining common object code in a so-called common module.

#### V. ACKNOWLEDGEMENT

The work is supported by the Russian Foundation for basic research, grants 17-07-01341, 18-07-00758, 17-47-380007.

#### REFERENCES

- [1] Market share ERP systems In Russia [Electronic resource]. URL: <http://www.tadviser.ru/index.php/ERP>. (in Russian) (Date of access 15.05.19)
- [2] 1C:Enterprise 8. Program system – [Electronic resource]. URL: [http://v8.1c.ru/predpriyatie/questions\\_licence.htm](http://v8.1c.ru/predpriyatie/questions_licence.htm) (Date of treatment 15.05.19)
- [3] Novikov F. A., Ivanov D. Yu. a. Modeling in UML. Theory, practice, video. // SPb.: Professional literature, Science and technology, 2010. — 640 pages
- [4] National open University INTUIT – [Electronic resource]. URL: [https://www.intuit.ru/studies/professional\\_skill\\_improvements/12-10/courses/6/lecture/182?page=2](https://www.intuit.ru/studies/professional_skill_improvements/12-10/courses/6/lecture/182?page=2) (Date of access 15.05.19)
- [5] IBM Developer – [Electronic resource]. URL: <https://www.ibm.com/developerworks/ru/library/x-xjavaforum5/index.html> (Date of access 15.05.19)
- [6] The Community of Programmers. The source code of our knowledge - [Electronic resource]. URL: <https://python-scripts.com/object-oriented-programming-in-python> (Date of access 15.05.19)
- [7] The Community of Programmers. The source code of our knowledge - [Electronic resource]. URL: <https://python-scripts.com/sqlite> (Date of access 15.05.19)

# An Algorithmic Method Based on Laplace Transformation to Improve the Quality Indicators for Strain Gauges

Vladimir Gebow  
South - West University "Neophyte Rilsky", Blagoewgrad, Bulgaria  
e-mail: askon@abv.bg

**Abstract - It has been analyzed, that the electronic weighing machines can be applied to work in industrial conditions and in the mills. An algorithmically method is offered for overcoming the negative effect of the mechanical vibrations over the metrology indicators at the tense measurement in industrial conditions. This method gives us the possibility to increase the exactness of the measurement and control of the output in the mills. This algorithm is offered in the systems for output in the mills in Bulgaria, Serbia, Macedonia and 20 countries in the world, also in mill factory of „DON DON“ DOO, Zrenjanin.**

## I. INTRODUCTION

The measurement of weight & strength in industrial conditions is connected with over coming of the vibration effect in measurement of the useful signal strength. Mainly the strength of the vibrations, which affects the tense systems, is several times higher than the necessary exactness for measurement of the useful signal, which requires methods and means for their restriction. In some cases the source of the vibrations is identified and is the system result for control of specific technological process as in [1]. In most of the cases they cannot be identified. The vibration effect in the dosing can cause big troubles.

The main aim of our research is to identify the vibrations in industrial conditions – in electronic weight scale for measurement in the mills (Fig.1). Define the effect of vibration of the exactness in dosing and to restrict it.

## II. THE PRELIMINARY RESEARCH

The preliminary research showed following results:

A. The reduced error (to 25.0kg) of the relatively deviation during measuring the effort in result of the vibration of the electronic scales of "ASKON" is between 5.0%÷2.5%. The main aim in the industrial systems for tense metric control is that the error should not be more than 0.1% as in [2].

B. The vibrations have two mainly sources:

- They are the result of the dynamics of the efforts, which appear in the valves of the electronic scales. Increasing the time of waiting after each

cycle of closing or opening the valves decreases their influence.

- The vibrations, which are caused from outer effort. Their influence increases, when the dose is bigger.

C. The electric disturbances do not have high values, only if they are not caused by electric shock.

D. Changing the time for integration influences the deviation during the measurement of the dose. The research is carried out in the Karnobat's mill.

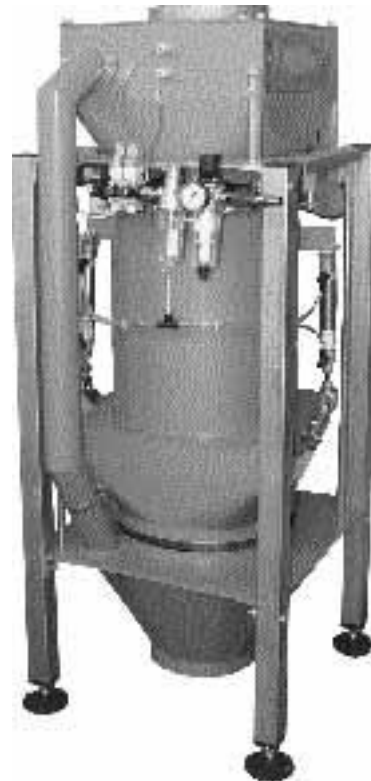

Fig. 1 Weigh scale for grain, flour and bran.

Because of the preliminary research, some measures have been taken:

- The waiting time after closing the valves is increased.

- The vibrations are shown on the display.

These preliminary measures could not help us to eliminate the main factor of the vibrations.

My main aim is to identify the vibrations, to define their influence over the exactness of dosing and to find a way to restrict their affect. To define the influence of the different frequencies of the vibrations, I used the operator method for transforming the function with singly entry influence  $1(t)$  s with transforming by Laplace  $\mathfrak{Z}[1(t)]=1/p$ . We can develop the dependency of the transitional process during

passing signal disturbance for interval  $0 < t < \Delta t$  and  $\Delta t < t < \infty$ :

$$G(t) = \begin{cases} 1(t)t & | 0 < t < \Delta t \\ 1(t)\Delta t & | \Delta t < t < \infty \end{cases} \quad (1)$$

After transforming the function  $G(t)$  by Laplace

$$\mathfrak{Z}[G(t)] = \int_0^{\Delta t} 1(t)t e^{-pt} dt + \Delta t \int_{\Delta t}^{\infty} 1(t)t e^{-pt} dt = \frac{1 - e^{-p\Delta t}}{p^2} \quad (2)$$

$$W(p) = \mathfrak{Z} \left[ \frac{G(t)}{1(t)} \right] = \frac{1 - e^{-pt}}{p}$$

Then to receive the argument and the module you have to replace  $p$  with  $j\omega$

$$W(j\omega) = \frac{1 - e^{-j\omega t}}{j\omega}$$

Then you replace the meaning of  $e^{-j\omega t}$  from Euler's formula and the result is:

$$W(j\omega) = \frac{1 - \cos(\omega\Delta t) + j \sin(\omega\Delta t)}{j\omega} = \frac{\sin(\omega\Delta t)}{\omega} - j \frac{(1 - \cos(\omega\Delta t))}{\omega} \quad (3)$$

The module of the preliminary function (3) is presented by the following way:

$$|W(j\omega)| = \sqrt{\frac{4 * \sin^2 \omega\Delta t}{\omega^2} + \frac{(1 - \cos \omega\Delta t)^2}{\omega^2}} = \sqrt{\frac{4 * \sin^2 \frac{\omega\Delta t}{2} \cos^2 \frac{\omega\Delta t}{2}}{\omega^2} + \frac{4 * \sin^4 \frac{\omega\Delta t}{2}}{\omega^2}} = 2 \frac{\left| \sin \frac{\omega\Delta t}{2} \right|}{\omega}$$

And the argument is

$$\varphi = \arctg \frac{-(1 - \cos \omega\Delta t)}{\sin \omega\Delta t} = -\frac{\omega\Delta t}{2}$$

The lag characteristic of the received operator is shown on Fig.2 .

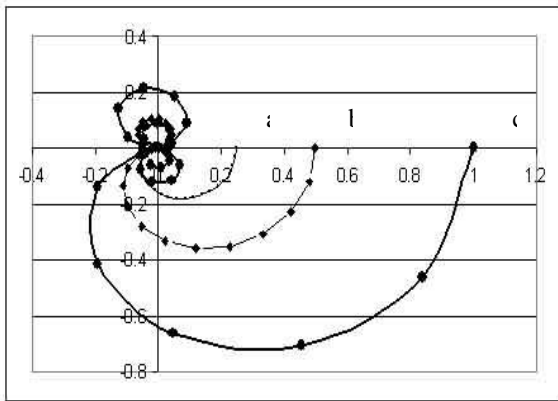

Fig.2.Lag characteristic for vibrations with different frequencies:

a-  $\Delta t=0.25$ , b- $\Delta t=0.5$ , c- $\Delta t=1.0$

For.3. the received coefficient of transmission at  $w=0$  is:

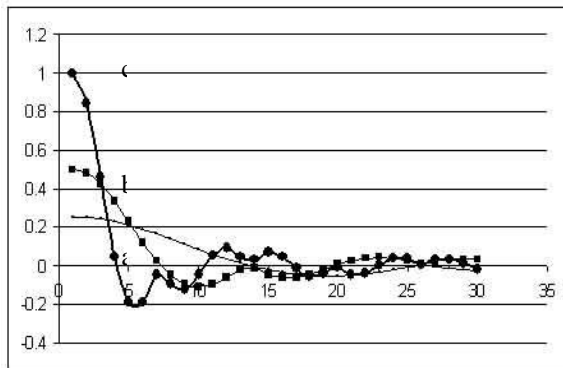

Fig.3. the real frequency characteristic for different periods of integration and for different frequencies of the vibrations are the following:

a-  $\Delta t=0.25$ , b- $\Delta t=0.5$ , c- $\Delta t=1.0$

$$k = \lim_{\omega \rightarrow 0} 2 * \frac{\left| \sin \frac{\omega \Delta t}{2} \right|}{\omega} = \Delta t \quad (4)$$

After the analyze of Fig.2 and Fig.3 the following conclusions can be drawn:

- If we increase the time for integration, the module will be increased at lower frequencies of the vibrations as well. The process goes quickly to zero for longer periods of integration  $\Delta t$ .
- Very important for this process is the regularly returning at zero, when the frequency values of

$$\omega = \frac{2n\pi}{\Delta t}, n = 1, 2, 3..$$

the vibrations are: and

receiving the local minimums

$$\omega = \frac{(2n-1)\pi}{\Delta t}, n = 1, 2, 3..$$

- When the frequencies of the vibrations are increased, the deflection of the characteristic are decreased, regardless of the values of  $\Delta t$ . The first passing through the zero is easiest and for different frequencies – with change of  $\Delta t$ .

As a result of the explained conclusions an algorithm for restriction of the vibration influence has been developed. The aim of this algorithm is to restrict the influence of the vibrations over the exactness of measurement of the signal at the tense transformers. In addition to this the method for crawling integration with changing the periods for integration of  $\Delta t$  is used. The algorithm, shown at Fig.4, should be fulfilled at the following consequence:

A. You should choose the spectrum of the frequency of the vibrations, in which the system will work to restrict their influence over the process of measurement. The vibrations at the mills cannot be expected to be higher than  $> 50.0\text{Hz}$ , because they are caused by asynchronous engines. On the other hand, it is not allowed to decrease the lower border frequency, because if the integration of  $\Delta t$  is increased, the productivity of the weighing scale will be decreased.

B. The periods for crawling integration are defined and at initial conditions they have maximal possible values. In this case the max. time for integration is 2.0Sec.

C. The middle-square deviation of the defined time for crawling integration for a longer period should be calculated. The time for crawling integration should be decreased and at the same time, the output frequency of the transformer should be increased. The main aim of this frequency decreasing is to reach the minimum of the middle-square deviation of the values.

D. The minimum of the coefficient of the variation should be defined  $vP(\Delta t)$  The defining of the coefficient is connected with consistently change of the time for integration at the spectrum  $[\Delta t_{\text{max}} \div \Delta t_{\text{min}}]$ . ( $\Delta t_{\text{max}} = 2\Delta t_{\text{min}}$ ).

### III DISCUSSIONS

1. Using the transducer AD7730 [6] is recommended in this method as in [3]. The amplifier UTI-SMARTEC [5] is not available in this case, because of two fixed frequencies – 10.0Hz, 100.0Hz. Using AD7730 it is possible converting with differences in the frequent discretions of the entry signal of tension sensitive bridges one frequency of vibrations, entering in transducer.

2. At eventually change of the kinematical scheme, where the device takes part, is necessary to develop new procedure in finding the appropriate time for integration, because this change can cause a new frequency of vibration.

3. The restriction of the effect of the vibrations by algorithmically method reaches 20.0dB.

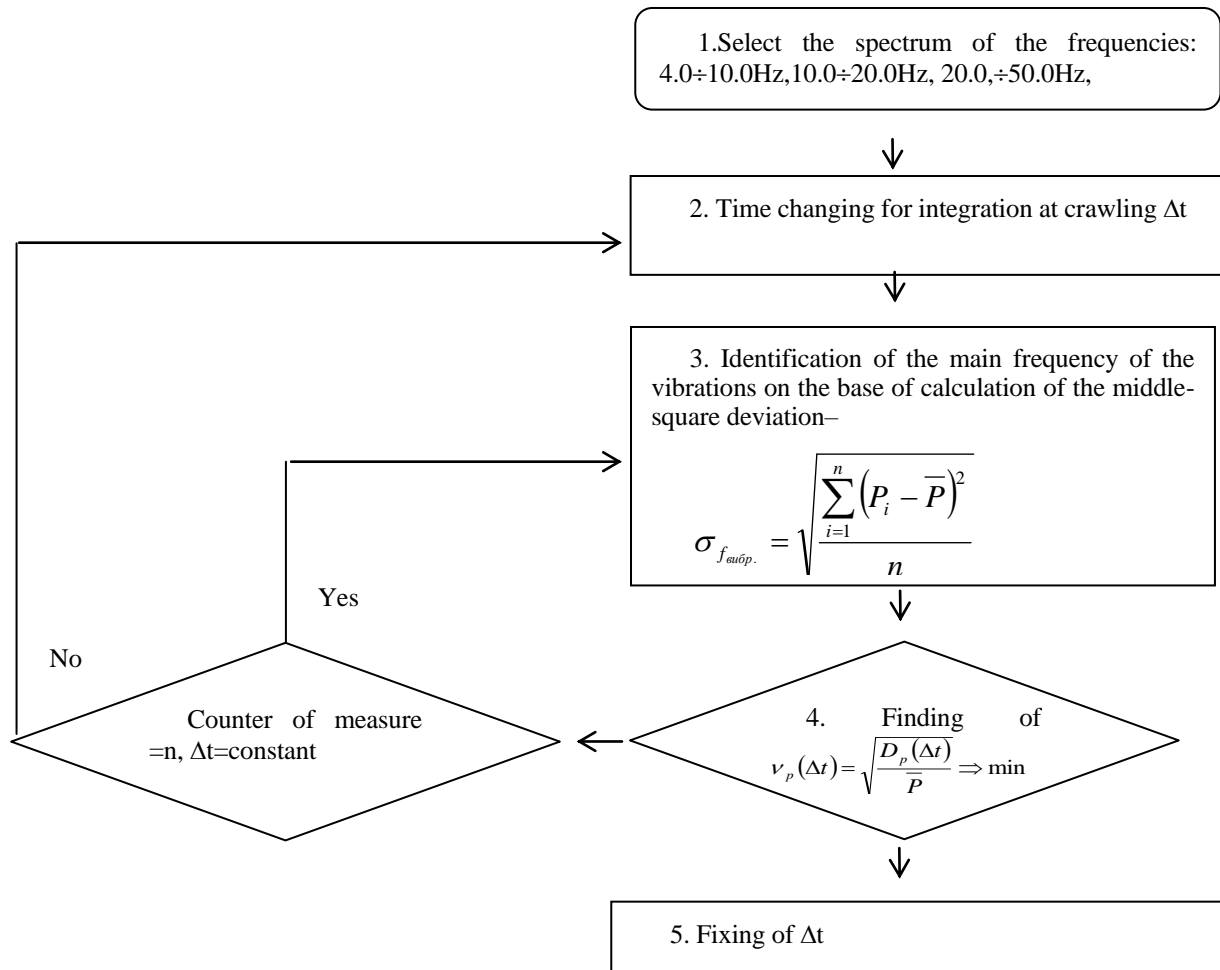

Fig.4. Flowchart of the algorithm for restricting the vibrations at measurement with tense systems.

#### IV CONCLUSION

1. By using the tense metrical method of strength measurement in industrial conditions a problem with the effect of vibration appears. The mechanical means and methods are not always effective in some cases. Restricting the effect of vibration is the possibility from algorithmic methods.

2. Algorithm is realized with software based on Embedded Systems Mixed C and Assembly Programming. Embedded Systems is developed on controller MC68HC812A4 of the Freescale [4]. Controller is connected to Personal computer by Modbus- TCP/IP [7] protocol.

3. The data from working the algorithm are written on Database online. The result of the Analyze of the data is to change parameters of the algorithm. This is the first step. Adjustments of the parameters are made by connection the controller with personal computer (PC). PC is connected via internet. The second step is change of the structure of the algorithm by the bootloader. Bootloader is resident software made for remote upload the new software of the controller.

#### REFERENCES

- [1] C. Clark, R. Cheesewright, *The influence upon Coriolis mass flow meters of external vibrations at selected frequencies*, Flow Measurement and Instrumentation, Volume 14, Issues 1-2, March-April 2003, Pages 33-42 [C.R.].
- [2] G. Mihov, *Weight measure adjusting using two measure bridges* ELECTRONICS –ET'2011-Sozopol(BG) [G.M.3]
- [3] I.Georgieva, *Automated observation of the angel of the leases turning*, Third science-technical conference "Technical-economic prognoses and analyses", Varna, 3-4 October 2012.
- [4] [www.freescale.com](http://www.freescale.com)
- [5] [www.smartec-sensors.com/cms/](http://www.smartec-sensors.com/cms/)
- [6] [www.analog.com/](http://www.analog.com/)
- [7] [www.modbus.org](http://www.modbus.org)

# An Overview of Security Risks in Information and Communication Systems

S. Mihajlović

University of Novi Sad, Technical Faculty "Mihajlo Pupin", Zrenjanin, Republic of Serbia  
mihajlovicsinisa25@gmail.com

**Abstract** – This paper presents security threats in information and communication systems. Information and communication systems are constantly evolving, and everything is in digital form and on the Internet. From all this comes a new form of cybercrime. Cyber security is becoming very important, but it is also not enough for the cyber threats that threaten us daily. An overview of the most common threats is presented. In addition, the trend of threats for 2016/2017 according to the RATEL report is presented, as well as the presentation of threats by industry for 2016/2017 according to the Verizon report.

## I. INTRODUCTION

Digitalization has become a daily use with the rapid development of information and communication technologies. The benefits of digitalization are access and storage of data. Virtual storage (cloud) is used to store and process data due to the need for higher capacity and lower costs. The cloud can house all information and communication resources such as memory, applications, programs and services. Through wireless access, most used devices are connected to the Internet. The improvement of business and education has been achieved through the process of digitization [1].

Considering the digitalization as well as the rapid growth of human population, and therefore the growth of computer and Internet users the cyber security becomes very important. The wide usage of IT creates limitless opportunities for new forms of cybercrime. Cybercrime is on the rise due to variety of reasons. One of the most recent ones is cryptocurrency, which offers criminals the ability to be anonymous. Due to the rapid advancement of technology, there are no adequate security policy and legislation. There are groups of hackers that act on the so-called Dark web, where they exchange information, tools, etc. [1]

The Law of Information Security was adopted in the Republic of Serbia, which states that RATEL (Regulatory Agency for Electronic Communications and Postal Services, Republic of Serbia) is responsible for coordinating and executing the activities of the National Center for Security Prevention in ICT systems [2].

## II. AN OVERVIEW AND BRIEF EXPLANATION OF THE MOST COMMON THREATS

According to the RATEL report in 2017, malware was the most commonly detected cyber threat. Antivirus

software detected more than four million attacks a day, or more than 700 million in the first quarter of last year, while hundreds of malicious solutions can be purchased on the black market [1]. The identified features of the malware are as follows:

- increased number of infections that do not require user to click,
- execution of scripts using tools already installed on the victim's device,
- infection of the network with the help of specific worm options,
- usage of vipers (tool to delete traces of presence from the hard drive),
- script-based malware hidden in potentially unwanted programs,
- escalation of malware delivery through adware,
- targeting vulnerabilities in hardware firmware,
- usage of hybrid attacks (combining two attack techniques with the aim of concealing the former's activity),
- usage of short-term domain name generation algorithms, thus avoiding blacklists, regenerating domains and thus remaining unidentified for extended periods of time,
- supply chain attacks (for example, by inserting malicious code into prescribed enterprise software, which heavily uses the admin system to analyze Windows logs, so that when users download software from the vendor, all users become infected) [3].

Web-based attacks target systems and services that are web oriented (search engines, websites, web service components and web applications) [1]. These attacks most commonly include:

- web browser exploits,
- web servers and web services exploits,
- drive-by attacks,
- water-holing,
- redirection and

- man-in-the-browser [3].

Web-based attacks are often combined with malware. The growth trend in 2017 shows that web-based attacks will reach malware threats. Figure 1 shows distribution of web attack sources by country for 2017 in the second quarter.

Web application attacks target the available web and mobile applications as well as web services. The most common targets are applications from government agencies and organizations and financial institutions, those developed in environments such as WordPress, Magento, etc. [1] Figure 2 shows web application attack vectors in 2017 for the second quarter.

Phishing is a cyber-attack that primarily uses social engineering to deceive victims, and is associated with attacks such as bots, malware, web attacks, exploit kits, cyber espionage [1]. Figure 3 shows top sources of spam by countries.

Spam has been the most common and persistent form of cyber-attack since the advent of the Internet. Spam is the main way to deliver malware, via malicious attachments and URLs. Denial of Service (DoS) attacks, especially distributed ones DoS (DDoS) are still a big threat to all types of businesses which also have an online presence in the market [1].

Extortion software or ransomware is a form of attack whose profitability is steadily increasing. About 60% of successful billing is extracted with the help of malicious software ransomware, while the rest accounts for fraud and other types of malware. IoT botnets are considered the second most important threat in 2017, after a major attack called Mirai which happened at the end of 2016 when the DNS service of the DYN provider was attacked. An estimated 8.4 billion devices are connected to the Internet in 2017. A large percentage of these devices contain malicious vulnerabilities that make them part of a bot network for DDoS attacks. Information security threats within the organization (Insider threat) pose individuals who may abuse the privileges granted. This type of attack has been a major risk in government institutions for years, because it is very difficult to distinguish malicious from regular activities [1].

Although data loss, damage, theft and manipulation are not cyber threats in all cases, they are certainly one of the biggest causes of data compromise. In 2017, data breaches were most often the result of weak, stolen, or detected passwords, and attacks were mostly directed at state institutions. Identity theft is a cyber threat that seeks to obtain confidential information and personal information. These can be: first and last name, address, contact information, credit, financial information, health information, etc. One of the biggest threats in 2017 was the disclosure of confidential information and data, from personal data collected by Internet giants and online services, to business data stored in company databases. About 78% of social network users therefore considered deciding to shut down accounts. Exploit kits are collections of ready-made packages used to attack websites or malicious campaigns by identifying vulnerabilities in search engines or web applications and

then misusing them. The most commonly exploited vulnerabilities concern Java and Adobe Flash. In 2017, cyber espionage was considered one of the most serious threats to legal entities. 20% of US companies have suffered this type of attack, while 20% of global organizations consider this type of threat the most critical [1].

### III. AN OVERVIEW OF THE GROWTH TREND FOR THE 2016/2017 RATEL

The presentation of threats throughout 2017 is the result of collection, analysis and evaluation, and the source is the Open Source Intelligence (OSINT) public domain. The ENISA survey timeframe is December 2016 to December 2017 (Table 1). The information gathered and the assessment performed covers most of the significant cyber threat-relevant events [3].

Continuing with the trend of previous years incidents have increased over the reporting period. During 2017, ransomware attacks dominated. Significant development is the increase in phishing / spear phishing: it has covered the gaps created by the legal cancellation of malicious infrastructure components such as botnets and exploit kits. The information gathering conducted in 2017 included CERT-EU collaboration, ENISA and the CYJAX Threat Information Portal. Malware information was taken through the MISP malware sharing platform [3].

TABLE I. COMPARISON OF COMPLETED AND RECORDED CYBER THREATS AND ATTACKS IN 2017 VERSUS 2016 [3]

The most common threats 2016	Trend 2016	The most common threats 2017	Trend 2017	Changes in ranking
Malware	↑	Malware	→	→
Web-based attacks	↑	Web-based attacks	↑	→
Web application attacks	↑	Web application attacks	↑	→
Denial of service	↑	Phishing	↑	↑
Botnets	↑	Spam	↑	↑
Phishing	→	Denial of service	↑	↑
Spam	↓	Ransomware	↑	↑
Ransomware	→	Botnets	↑	↓
Insider threat	→	Insider threat	→	→
Physical manipulation/ damage/theft/ loss	↑	Physical manipulation/ damage/theft/ loss	→	→
Exploit kits	↑	Data breaches	↑	↑
Data breaches	↑	Identity theft	↑	↑
Identity theft	↓	Information leakage	↑	↑
Information leakage	↑	Exploit kits	↓	↓
Cyber espionage	↓	Cyber espionage	↑	→

Legend: Trends: ↑ Increasing, → Stable, ↓ Declining

Ranking: ↑ Going up, → Same, ↓ Going down

Structure description templates for displaying the top 15 threats:

- trends and main statistics including geographical information, where relevant,
- major threats in the category,
- specific attack vectors used to launch the threat,
- reduction of actions,
- cyber threat interruption chain and
- relevant references [3].

The fifteen largest estimated threats are those that have dominated the threat environment. Although there were no new threats, there were some changes in the ranking. These changes reflect developments that have suffered cyber threats. Some interesting observations regarding the presented cyber threats and their ranking are as follows:

- Data breaches and identity theft are not thought to be typical cyber threats. Instead, they are the consequences of successful threats (i.e. actions on targets, if formulated according to the interruption chain). In other words, to break the information, one or other of the other cyber threats must be successfully launched. Data breaches and identity theft are on the list of major attacks.
- Some of the 15 cyber threats belong to the same threat category. Ransomware, for example, is a malware specialization of the threat type. All malware protection measures must be implemented with additional measures specific to this threat, i.e. in this case the ransomware. The same goes for identity theft, which is a special category of data breach. However, it is handled separately, as this threat is triggered by special malicious artifacts.
- Cyber espionage is more a motive than a cyber threat. It mainly unites almost all other Internet threats, with some high-profile threats specifically crafted by state-sponsored organizations, such as advanced hacking tools, vulnerability detection, and a combination of military / police intelligence methods.
- Ranking in the list is indicative. The position is based on the number of incidents, the impact, and the role played by other cyber threats. The possibility that cyber threats shared the same position in the rankings was not considered. This leads to an interesting situation where even though the threat is increased it is ranked lower just because another cyber threat is ranked higher, which affects the ranking of those below [3].

#### IV. INDUSTRY THREAT DISPLAY FOR 2016/2017 VERIZON

The following is an overview of the industries. Some specific industries were selected because of the importance of statistics. Table 2 shows the number of security incidents by victim industry and the size of the organization for 2016 but does not show which industry is secure, but rather an indication of how many industries are represented [4].

Table 2 shows number of security incidents by victim industry and organization size for 2016.

Accommodation and Food Services were most dominated by point of sale (POS) breaches. Most of them are financially motivated and involve malware and hacker threats. Fraud detection is on the rise compared to previous years. Educational Services focuses on confirmed data breaches and is still the target of Denial of Service (DoS) attacks. The number of espionage offenses increased significantly in 2016. DoS was the most common type of incident in Financial and Insurance. Data breaches were often linked to the theft of Trojan banking and the re-use of user passwords, along with ATM download operations [4].

Healthcare is tasked with balancing the protection of large amounts of personal and medical information with the need for quick access to physicians. Internal stakeholders and employees can access patient data for curiosity or to commit identity fraud. Incidents and breaches within the information sector are strongly associated with web servers. Most manufacturing injuries are gains from strategic advantage through espionage actions. There are cases of internal espionage secrets stealing trade secrets, but most are done by government-related actors. In the Public Administration, almost half of the attacks that resulted in verified disclosure are affiliated with the state. Online retailers are targets of DoS attacks, and the POS environment remains compromised due to financial motivation [4].

Figure 4 shows industry comparisons, all security incidents and breaches only.

Figure 5 shows that industries using the Internet for business or communication have the potential to suffer multiple Distributed Denial of Service (DDOS) attacks. Numerous industries display DDS as their most prominent pattern.

Figure 6 represents the extent to which industries are vulnerable to phishing attacks. The results show that no industry is at 0%, and most industries are not significantly different in terms of the percentage of users who click on a phishing link or attachments.

Amount of space represents the amount of malware detonations in each category by industry. For example, production organizations are often recipients of email-based malware that supports incident data. Across the industry, email is the path that most malware delivers to organizations [4].



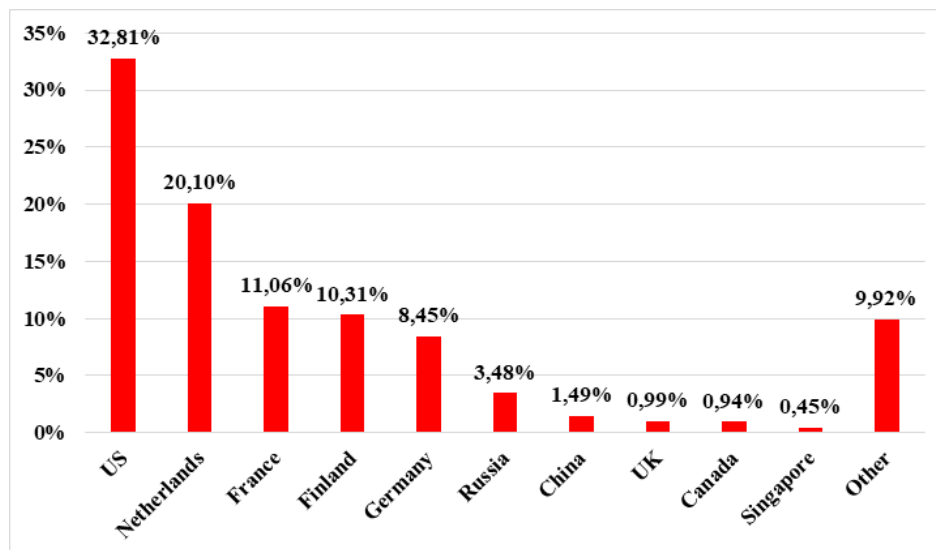

Figure 1. Distribution of web attack sources by country, Q2 2017 [3]

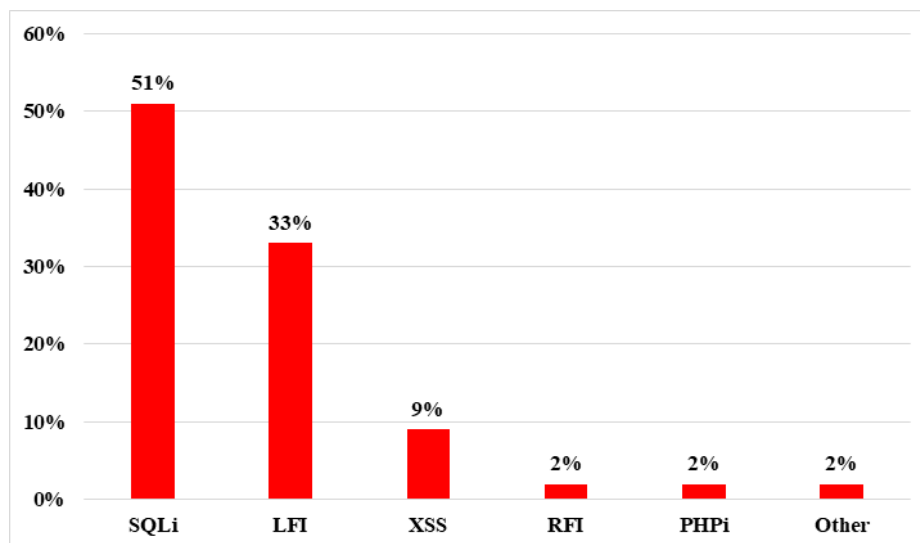

Figure 2. Web application attack vectors in Q2 2017 [3]

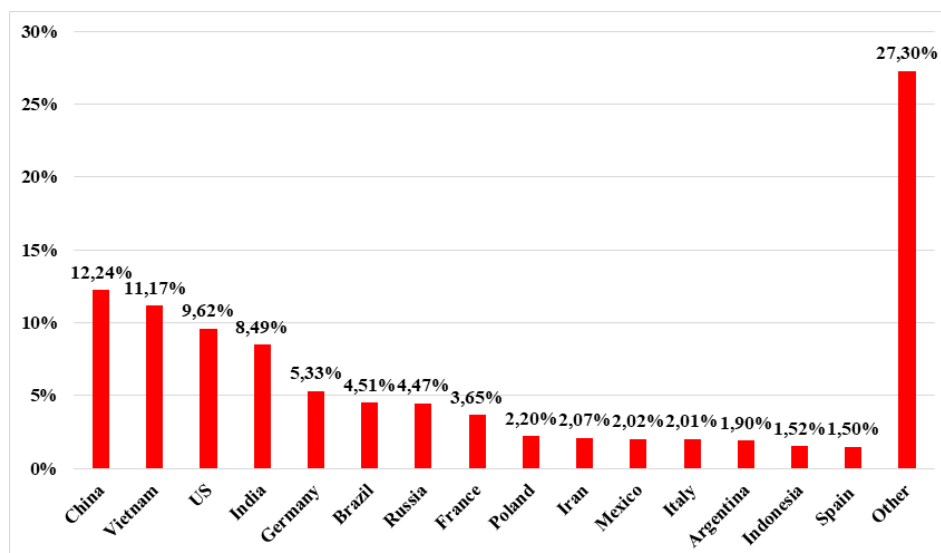

Figure 3. Top sources of spam by countries [3]

**International conference on Applied Internet and Information Technologies  
October 3-4, 2019, Zrenjanin, Republic of Serbia**

		Accommodation	Education	Finance	Healthcare	Information	Manufacturing	Public	Retail	Accommodation	Education	Finance	Healthcare	Information	Manufacturing	Public	Retail
Pattern	Denial of Service	4	228	445	3	508	10	617	180				1	2		1	
	Privilege Misuse	5	7	48	125	23	13	7417	9	5	5	26	104	13	8	58	6
	Lost and Stolen Assets	5	13	10	92	4	2	5519	4	4	3	2	42	2	1	7	
	Everything Else	8	106	20	40	32	213	88	8	8	14	16	28	24	4	19	3
	Point of Sale	182		3	4	1			9	180		3	3				8
	Miscellaneous Errors	2	24	14	114	13	3	2246	16	1	16	10	96	9	2	38	12
	Web App Attacks	4	25	376	32	73	4	148	28	3	11	364	15	61		13	24
	Crimeware	5	32	30	54	63	261	5102	14		5	7	12	1	2	5	1
	Payment Card Skimmers	6		53			1	1	57	5		44				1	39
Cyber-Espionage		22	5	2	4	115	112	3		19	5	1	4	108	98	1	
Action	Hacking	176	394	850	84	616	588	958	220	171	43	387	48	89	111	130	30
	Misuse	5	7	48	125	23	13	7417	9	5	5	26	104	13	8	58	6
	Physical	12	11	64	73	4	2	18	62	10	2	46	31	2		11	39
	Social	9	131	385	37	47	390	147	24	9	32	372	23	37	109	102	20
	Error	2	28	18	154	16	5	7763	16	1	19	11	119	10	3	47	12
	Malware	187	58	395	66	11	358	5219	42	180	26	370	18	42	92	103	24
	Environmental																
Asset	Server	185	367	874	184	634	68	880	234	175	34	399	123	101	10	100	38
	Media	8	12	14	145	6	1	1440	11	7	5	10	105	5	1	31	8
	User Dev	178	43	393	76	50	302	5691	36	174	18	367	25	34	63	109	23
	Person	10	132	387	41	48	390	149	24	10	33	372	27	38	109	104	20
	Network		2	6	3	6		3				1		2		1	
	Kiosk/Terminal	4		57			1	2	57	3		45				1	38
	Embedded																

Figure 4. Industry comparison (left: all security incidents, right: breaches only) [4]

TABLE II. NUMBER OF SECURITY INCIDENTS BY VICTIM INDUSTRY AND ORGANIZATION SIZE, 2016 DATASET [4]

	Incidents				Breaches			
	Total	Small	Large	Unk	Total	Small	Large	Unk
<b>Total</b>	<b>42068</b>	<b>606</b>	<b>22273</b>	<b>19189</b>	<b>1935</b>	<b>433</b>	<b>278</b>	<b>1224</b>
Accommodation (72)	215	131	17	67	201	128	12	61
Administrative (56)	42	6	5	31	27	3	3	21
Agriculture (11)	11	1	1	9	1	0	1	0
Construction (23)	6	3	1	2	2	1	0	1
Education (61)	455	37	41	377	73	15	15	43
Entertainment (71)	5534	7	3	5524	11	5	3	3
Finance (52)	998	58	97	843	471	39	30	402
Healthcare (62)	458	92	108	258	296	57	68	171
Information (51)	717	57	44	616	113	42	21	50
Management (55)	8	2	3	3	3	2	1	0
Manufacturing (31-33)	620	6	24	590	124	3	11	110
Mining (21)	6	1	1	4	3	0	1	2
Other Services (81)	69	22	5	42	50	14	5	31
Professional (54)	3016	51	21	2944	109	37,000	8	64
Public (92)	21239	46	20751	442	239	30	59	150
Real Estate (53)	13	2	0	11	11	2	0	9
Retail (44-45)	326	70	36	220	93	46	14	33
Trade (42)	20	4	10	6	10	3	6	1
Transportation (48-49)	63	5	11	47	14	3	4	7
Utilities (22)	32	2	5	25	16	1	1	14
Unknown	8220	3	1089	7128	68	2	15	51
<b>Total</b>	<b>42068</b>	<b>606</b>	<b>22273</b>	<b>19189</b>	<b>1935</b>	<b>433</b>	<b>278</b>	<b>1224</b>

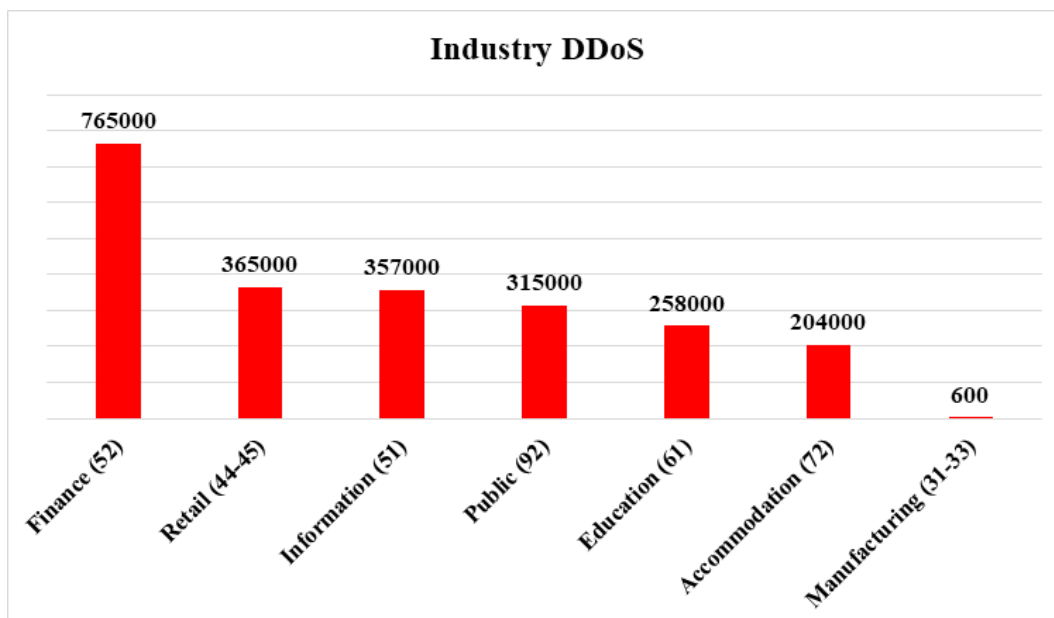

Figure 5. Median DDoS (pps) by industry (n=2133) [4]

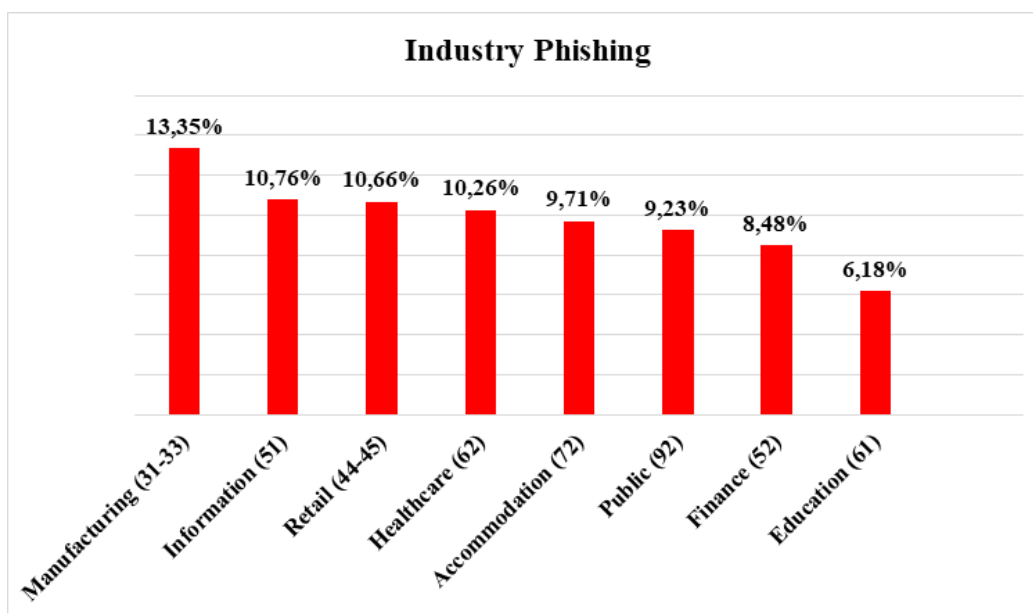

Figure 6. Median click rates per campaign by industry (n=7153) [4]

## V. CONCLUSION

Due to innovations in the IT industry, a new type of cybercrime is evolving. Cybercrime is on the rise. There are several cyber threats affecting cyber security. According to a RATEL report for 2017, individual cyber threats have increased cyber-attacks compared to 2016, with some remaining unchanged or declining. The number of industry attacks reported according to a 2017 report by Verizon. Security incidents and breaches have been compared, showing the vulnerability of industries to cyber-attacks. As technology evolves daily, so does cyber security, as well as cyber threats. As there is law, there is crime, as there is cyber security there will be cybercrime.

## REFERENCES

- [1] Regulatorna agencija za elektronske komunikacije i poštanske usluge - RATEL, Pregled tržišta telekomunikacija i poštanskih usluga u Republici Srbiji u 2017. godini, Beograd, 2018.
- [2] Regulatorna agencija za elektronske komunikacije i poštanske usluge - RATEL, Pregled tržišta telekomunikacija i poštanskih usluga u Republici Srbiji u 2016. godini, Beograd, 2017.
- [3] European Union Agency for Network and Information Security, ENISA Threat Landscape Report 2017, January 2018.
- [4] Verizon, 2017 Data Breach Investigations Report 10<sup>th</sup> Edition, 2017

# Role of Internet of Things (IoT) in Education

V. Premčevski

\* University of Novi Sad, Technical Faculty "Mihajlo Pupin", Zrenjanin, Serbia  
velibor.premcevski@tfzr.rs

**Abstract – Today, with the enormous development and cumulative role of technology, as technology has changed the world of education, IoT is gaining in popularity with its unlimited educational opportunities in both higher and primary education. IoT can interact with anything, anytime, and anywhere bringing people, processes, data and things together. It is used to ease some of our daily activities and gradually touching every facet of our lives, opening new opportunities for growth and innovation. Conventional and classical methods of education in classroom are no more attractive and efficient for the learners of the 21st century. With the increasing popularity of Internet of Things, small gadgets are gaining wide popularity, especially, when students use wearable devices with small sensors for connectivity with learning systems. This paper introduces IoT technology, its potential application in education system, and discusses benefits and challenges of IoT.**

**Keywords: IoT, internet, things, smart, education**

## I. INTRODUCTION

Technology has changed the world of education. From the use of tablets in the classroom to the innovative learning process of open universities, education has transformed the way we lead life. However, these progressions are negligible compared to the mass revolution that is happening in the education world due to the application of Internet of Things (IoT). [1]

The IoT- which links people, processes, devices and data- augments the quantity and value of the information we can collect, allowing the stakeholders of educational sector to turn data into valuable information as never seen before. With the initiation of mobile technologies, the educational institutions can now keep track of overall resources pertaining to education.

## II. IOT COMMUNICATION TECHNOLOGIES

The communication enabling technologies of IoT heavily depends on rapid technical innovation in 4 fields: technology used to connect everyday objects and devices to large databases and networks, technology used for data collection with ability to detect changes in the physical status of objects, technology to take action through embedded intelligence in objects, and finally to make smaller and smaller things will have the ability to interact and connect. The combination of all these developments made the effective and efficient communications on IoT applications.

### A. RFID

RFID is not new and it was popular in the early 20th century. Initially, it was based on radio waves and later radio waves combined with radar signals. They can be used to provide P2P connection between objects. RFID consists of three main components such as a transponder or tag to carry data, which is located on the object to be identified, an interrogator or reader, which reads the transmitted data, and Middleware, which forward the data to another system, such as a database, a PC or robot control system. Frequencies currently used for data transmission by RFID typically include 125 kHz (low frequency), 13.56 MHz (high frequency), or 800-960 MHz (ultrahigh frequency). RFID is set to revolutionize the retail sector. By 2008, according to IDTechEx, retailers worldwide are expected to account for over USD 1.3 billion of a global RFID market of USD 7 billion. RFID standards relate both to frequency protocols (for data communication) and data format (for data storage on the tag) [9]. Some of IoT applications reported in literature using RFID includes smart shopping, smart chips, arts and gaming, smart environment, RFID combats criminal activities in graveyards and sanctuaries, thwart baby abduction, smart waste management and health care [10].

### B. Sensors

Sensors are one of the key building blocks of the Internet of Things which can be deployed everywhere from military battlefields to vineyards. A sensor is an electronic device, which detects senses or measures physical stimuli and responds to it in a specific way. It converts signals from stimuli into an analogue or digital form, so that the raw data about detected parameters are readable by machines and humans. Sensors can also be implanted under human skin, in a purse or on a dress. Some can be as small as four millimeters in size, but the data they collect can be received hundreds of miles away. Sensors complement human senses and have become indispensable in a large number of industries, from health care to construction. Sensors have the key advantage that they can anticipate human needs based on information collected about their context. Common applications of sensors include military, environment, healthcare, construction, commercial applications, home applications, etc. [13]

*C. Sensors and Mobile Phones*

Mobile phones are already an integral part of everyday life for many people. Due to their widespread use, mobile networks play a key role in bringing new “ubiquitous” communication technologies to the masses. Today, mobile phones are not only a device for making calls, but it equipped with data, text and video streaming functions. Currently, the combination of sensors with mobile phones offers several possible applications such as device for relaying data collected by sensors, touch sensors, movement recognition, sensing the status of their environment through smell sensors, etc.[13]

*D. ZigBee*

ZigBee is a specification standard for a suite of high level communication protocols used to create personal area networks built from small, low-power digital radios. ZigBee is based on an IEEE 802.15 standard. Though low-powered, ZigBee devices often transmit data over longer distances by passing data through intermediate devices to reach more distant ones, creating a mesh network. They can used in applications that require a low data rate, long battery life, and secure networking.[13]

**III. APPLICATION DOMAINS**

The Applications of the IoT are numerous and diversified in all areas of every-day life of people which broadly covers society, industries, and environment. All the IoT applications developed so far comes under these three broad areas as shown in Table 1. According to Internet of Things Strategic Research Agenda (SRA) during 2010, 6 or more application domains were identified that are smart energy, smart health, smart buildings, smart transport, smart living and smart cities. According to the survey that the IoT-I project ran during 2010 65 IoT application scenarios were identified and grouped in to 14 domains, which are Transportation, Smart Home, Smart City, Lifestyle, Retail, Agriculture, Smart Factory, Supply chain, Emergency, Health care, User interaction, Culture and tourism, Environment and Energy. Some of the IoT applications are briefly explained in next coming paragraphs.[11]



Figure 1- IoT Applications

*A. Smart Cities*

The IoT and all related information technology employs the Internet to consolidate various devices with each other. In this regard also to facilitate the approachability all available devices should be connected to the Internet [4]. To fulfill this purpose, sensors, actuators, cloud, data science, communication technologies, machine learning, and Artificial Intelligent can develop at various locations for analyzing and collecting data to increase the usage. Figure.1 illustrates the primary applications of the IoT for smart cities.

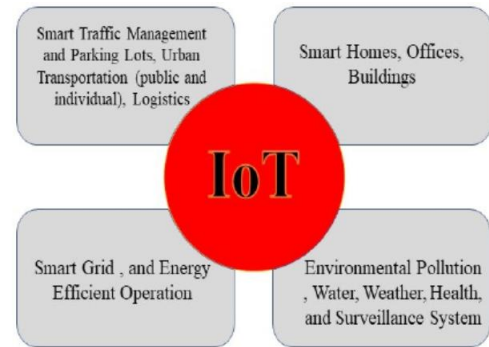

Figure 2– Application of Iot for Smart City

*B. Smart Agriculture*

With the adoption of IoT in various areas like Industry, Homes and even Cities, huge potential is seen to make everything Intelligent and Smart. Even the Agricultural sector is also adopting IoT technology these days and this in turn has led to the development of “AGRICULTURAL Internet of Things (IoT)”. [11]

*C. Health Care [14]*

Information and communication technologies are amongst the tools that could help mitigate some of the problems associated with aging populations, increased rates of chronic illnesses, and shortage of health professionals, and, at the same time, facilitate service reorganization. Modern measuring devices, such as, blood pressure, weight, and movement sensors, incorporate communication capabilities. They can create IoT networks implemented for home telemonitoring. These same devices are those usually employed by health workers to check the overall condition of patients with chronic illnesses. [14]

*D. Security*

The IoT technologies in the field of security and emergencies are tremendously increased in which few are listed; perimeter access control, liquid presence, radiation levels and explosive and hazardous gases, etc.

**IV. IOT APPLICATION AREAS IN EDUCATION**

IoT affects the education sector directly and indirectly.[5] Mainly it does the overall work ease and upgrades the quality of education. It affects the teaching and learning process broadly. The assessment area of education needs the real treatment and IoT is well suitable for the real implementation in this sector. Once

the core areas such as teaching, learning, assessment are taken into consideration, the major aspect will be upgraded.

IoT is playing the key role in teaching, Learning and even in assessment. From KG to PG in all aspects of the education institution, the IoT is becoming the need of the hour. The implication of IoT will help the overall delivery of the resources in an innovative manner to the participants. The IoT has the potential to impact every aspect of student learning. This insight provides stakeholders with a real-time view of students, staff, and resources. It helps in decision making, automatic execution and providing security features. [2]

As teachers are faced with classroom issues such as excessive talking during instruction, getting out of seat without permission, throwing objects across the room, sleeping during classroom instruction and disrespect to the teacher. It is important that teachers find creative ways to deal with the issues as well as provide quality instruction in the classroom. Classroom management and classroom instruction are connected. [4]

IoT also plays an important position in constructing a network through the use of special internet-based systems. A robust faculty attendance gadget guarantees the safety of an academic enterprise and may assist colleges and education facilities in many methods.[6]

#### A. Smart Education

In smart campus sector, the learning process is conducted through e-Learning system, that makes it possible for students to be able to join learning from anywhere, anytime with the internet connection. E-learning equips with video conference facility so that it is possible for students to face the teacher from different place. Besides, virtual class feature can help simulation for students to solve problem in learning. Virtual class can be used for practicum lessons.

#### B. Smart Room

It uses the sensor of PIR, RFID, and camera. The concept of smart room is giving information about the vacant room, and the amount of the students being present on it. The data about amount and the name of the students are saved on the database. In this system, the students use RFID, so that the data of the students are in database. Smart system is being used in smart room. By using the sensor of PIR, the lights will be off automatically if there is no human in the room. On the other hand, the lights will be automatically on if there is or there are people in it.[7]

#### C. IoT for Special Needs (learners with disabilities)

Sensor gloves that provide feedback to children learning sign language from a computer. The learner wears the glove while attempting to sign; the sensor information is fed back to the computer, which gives the learner feedback on his or her accuracy in signing.

Headsets that help learners who have Attention Deficit Hyperactivity (ADHD) and/or are easily

distracted. The headsets detect brain activity and reward learners when they demonstrate improved concentration.

#### D. IoT for educators

When both students and educators have IoT devices connected to the cloud, they can communicate readily, and accountability goes up. Teachers can identify which students require assistance, and which are managing their time well and turning in work on time. Educators can also communicate with each other, and substitutes can be looped in for lesson plans, adjusting schedules and more. When these tasks are streamlined or automated, educators can spend more time on the core job of teaching and less on administrative tasks and paperwork. Many schools are now providing students and educators with tablets and laptops, enabling connected technology which can streamline homework collection, worksheet submission, test taking, and checking / grading of everything from homework to tests to reports or essays. [9]

#### E. Smart Learning

Integration of IoT as a new actor in intelligent learning can facilitate the interaction between people (learners and teachers) and objects (Devices, RFID Tag ...) in the school environment. This interaction means that objects can communicate with each other and with people who are in these educational environments.

Smart learning process lets learner complete their coursework on their mobile devices (Tablets, Smartphones, Laptop, connected objects...) and learners have complete access to their real time class and collaborative learning from their mobile device.

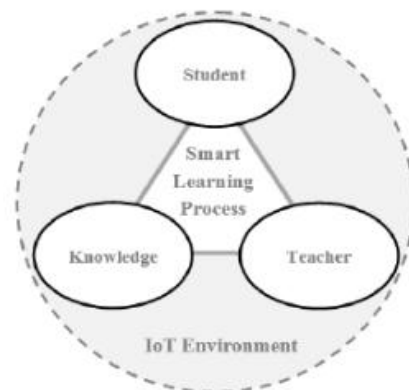

Figure 3- IoT In Smart learning

The structure of smart learning and a management system include the following aspects:

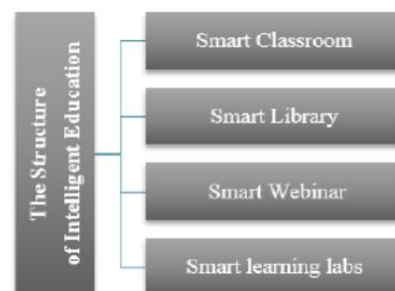

Figure 3. - The structure of smart learning

*F. Improved Operational Efficiency*

Educational institutions have a lot of participating stakeholders. To get the desired outcome, one should keep track of students, staff, and resources. The operation of each device can be managed effectively, diligently through the implementation of IoT technology. The effective operational management leads to the success of the overall system. The system comprises of various components. The keen concentrated individualized management of each object leads to the overall growth of the progress of the system. Hence the IoT implementation will be a successful strategy in uplifting the effectiveness of the system.[8]

**V. CONCLUSION**

Technology in education has played a significant role in connecting and educating the students. IoT technology has an important impact on education field. IoT has not only changed the traditional teaching practices but has also brought changes in the infrastructure of educational institutions.

The Internet of Things will be further integrated into the education system in the near future. Most of the schools may use it to prepare their students to become highly tech-literate while others may use it to harness data, save money, and for other specific needs. This paper provides introduction to smart and efficient education using IoT. Future directions are the implementation of smart class in an experimental generation of students.

REFERENCES

- [1] Marge Kusmin, IFI8101 - Information Society Approaches and ICT Processes
- [2] Cisco, The Internet of Everything: Fueling Educational Innovation
- [3] M. Mohanapriya, "IOT enabled Futurus Smart Campus with effective E-Learning : i-Campus," vol. 3, no. 4, pp. 81-87, 2016S
- [4] Hlaing Htaka Khaung Tin, Phyu Sin Phwe, Yi Mon Thet, San Thida, "Effective Classroom Management Information System to Improve Teaching and Learning Approach", International Journal of Advanced Research in Computer Science and Software Engineering, Volume 8, Number 8, 2018.
- [5] The Internet of Things in Higher Education, (2016), jenzabar.com/educause, Volume 51, Number 4
- [6] <https://data-flair.training/blogs/iot-in-education/>
- [7] <https://www.iotforall.com/introduction-iot-applications-in-education/>
- [8] Role of Internet of Things (IoT) for Smart Classroom to Improve Teaching and Learning Approach, International Journal of Research and Innovation in Applied Science (IJRIAS) | Volume IV, Issue I, January 2019|ISSN 2454-6194
- [9] <https://www.perle.com/articles/how-iot-is-affecting-the-field-of-education-40179384.shtml>
- [10] R.N. Murty, G. Mainland, I. Rose, A.R. Chowdhury, A. Gosain, J. Bers, et al., CitySense: an urban-scale wireless sensor network and testbed, 2008, pp. 583-588.
- [11] The Internet of Things (IoT) Applications and Communication Enabling Technology Standards: An Overview, 2014 International Conference on Intelligent Computing Applications, Dr. V. Bhuvaneshwari, Dr. R Porkodi
- [12] Observing system for the Great Barrier Reef, in: International Coral Reef
- [13] R. Johnstone, D. Caputo, U. Cella, A. Gandelli, C. Alippi, F. Grimaccia, et al., Smart environmental measurement & analysis technologies (SEMAT): wireless sensor networks in the marine environment, Stockholm, 2008.
- [14] Internet of Things in Healthcare : Interoperability and Security Issues, International Workshop on Mobile Consumer Health Care Networks, Systems and Services, Liane Margarida Rockenbach Tarouco, Leandro Márcio Bertholdo, Lisandro Zambenedetti Granville, Lucas Mendes Ribeiro Arbiza, Felipe Carbone, Marcelo Marotta, José Jair Cardoso de Santanna

# Web Services Security: an Overview

L.Perišić

University of Novi Sad, Technical Faculty „Mihajlo Pupin“, Zrenjanin, Republic of Serbia  
lidija.perisic82@gmail.com

**Abstract - This paper describes the application of web services as the basis for modern web applications. The work focuses on the application of security aspects of web services in distributed information systems. Like any software or web application, web services are also prone to security threats related to authentication, availability and integrity, so that new techniques and methods in the field of Web service security and data protection will be described.**

## I. INTRODUCTION

The rapid development and increasing importance of computer and communication technologies, necessary for modern business, requires that special attention be paid to the security issue. With the introduction of computers, the need for new and automated tools for protecting data, software and hardware has emerged. This is especially important for shared systems, such as file sharing systems, which are accessed through public computer networks. An important change that has affected security is the expansion of the deployment of computer networks, communications and distributed systems.

## II. COMPUTER SECURITY

Computer Security: The protection afforded to an automated information system in order to attain the applicable objectives of preserving the integrity, availability, and confidentiality of information system resources (includes hardware, software, information/data, and telecommunications).[1]

This definition introduces three key objectives that are at the heart of computer security:

- Confidentiality- Preserving authorized restrictions on information access and disclosure, a loss of confidentiality is the unauthorized disclosure of information.
- Integrity - Guarding against improper information modification or destruction, a loss of integrity is the unauthorized modification or destruction of information.
- Availability - Assures that systems work promptly and service is not denied to authorized users. This requirement relates to adequate response time and guaranteed bandwidth. Ensuring timely and reliable access to and use of information. A loss of availability is the disruption of access to or use of information or an information system. [1][2]

### A. Threats and attacks

Threats: A potential for violation of security, which exists when there is a circumstance, capability, action or event that could breach security and cause harm. Threat is a possible danger that might exploit vulnerability. [2]

Attack: An assault on system security that derives from an intelligent threat; that is, an intelligent act that is a deliberate attempt (especially in the sense of a method or technique) to evade security services and violate the security policy of a system. [2]

Vulnerability: is a weakness, something that, if exploited, could cause some unwanted effects. It could be a flaw in a system that can leave it open to attack. Reducing vulnerabilities provides fewer options for malicious users to gain access to secure information.

Risk is in the context of the security of computer systems and networks, measures of danger, or the possibility of damage or loss of information, hardware, intellectual property, prestige or reputation. [3]

Consequently, the concept of risk consists of two parts; the probability or the expected frequency of that an incident will occur and the potential damages an incident may cause. This can be expressed in the following equation: [4]

$$R=L*P$$

Where R stands for risk, L is potential loss and P is probability or expected frequency of loss.

The most common attacks and threats: Denial of Services (DOS), Distributed Denial of Service (DDOS), Spoofing, Sniffing.

### B. Security mechanism

Security mechanisms are technical tools and techniques that are used to implement security services. A mechanism might operate by itself, or with others, to provide a particular service.

Authentication verifies the authenticity of the identity declared at the identification stage. The aim is to obtain reasonable assurance that the identity declared at the identification stage belongs to the party in communication. Authentication methods are passwords, secret codes, and personal identification numbers (PINs), tokens (smart card or USB token), Biometric authentication methods include fingerprint, iris, and retina recognition, as well as voice and signature recognition. [19]



The overall goal of the non-repudiation service is to be able to prove that a particular message is associated with a particular individual. Non-repudiation is a relevant security service that can provide evidence that a particular message has been sent or received by an application associated with a specific person.

Authorization is a security mechanism to determine access levels or user/client privileges related to system resources including files, services, computer programs, data and application features. This is the process of granting or denying access to a network resource which allows the user access to various resources based on the user's identity. [39]

Audit Trail, in the context of IT, is an electronic record that chronologically records all procedures to ensure the documentation and history used to authenticate security and operational actions. These records provide evidence of compliance and operational integrity. The trace records contain details that include the date, time, and user information associated with the transaction, thus validating actions and results. Audit trails maintain records necessary to support accountability, and are usually closely related to authorization and authentication, so that any authentication is recorded, and any attempt to access, whether authorized or not. [2]

### C. Cryptography

Cryptography is one of the methods of storing and transmitting data in a particular form so that only those to whom it is intended can read and process. The sender converts the plaintext message into cipher text, the process is called encryption, then the encrypted text is transmitted to the receiver, which converts the encrypted text message to plaintext, this part of the process is called decryption. [5]

Conversion involves a series of mathematical operations that change the appearance of a message during transmission but do not affect the content. Cryptographic techniques can ensure confidentiality and protect the message from unauthorized viewing because the encrypted message is not understood.

### D. Firewall

A firewall is a network security device that monitors incoming and outgoing network traffic and decides whether to allow or block specific traffic based on a defined set of security rules.

Using a firewall establishes a security mechanism that can help protect your computer or network from harmful incoming traffic, thereby reducing the possibility of undiscovered data being expelled by a malicious insider.

## III. DISTRIBUTED SYSTEMS

Distributed system is a system in which hardware or software components located at networked computers, communicate and coordinate their actions

only by passing messages. This definition of distributed systems has the following significant consequences: concurrency of component, no global clock, independent failures. [11]

Distributed system consists of components that are autonomous. Users think they are dealing with a single system. This means that the autonomous components need to collaborate. How to establish this collaboration lies at the heart of developing distributed systems. [9]

Some of the established or emerging uses of distributed systems technology by key commercial or social application sectors are:

- Finance and commerce – e-Commerce – Amazon and eBay; underlying payments technologies such as PayPal;
- The information society – Google, Yahoo, Facebook, YouTube.
- Healthcare – telemedicine.
- Education and Science – e-Learning, e-Science.
- Transport and logistics - MapQuest, Google Maps and Google Earth. [11]

As can be seen, distributed systems encompass many of the most significant technological developments of recent years and hence an understanding of the underlying technology is absolutely central to knowledge of modern computing, also provides an initial insight into the wide range of applications in use today.

### A. Web services technology

XML, SOAP, WSDL, and UDDI are the basic standards and technologies on which web services are based and used in the development of web services and in applications that use web services. The role of web services technologies is to establish interaction between web service requesters and web service providers.

Figure 1 shows the basic standards of web services and the links between them.

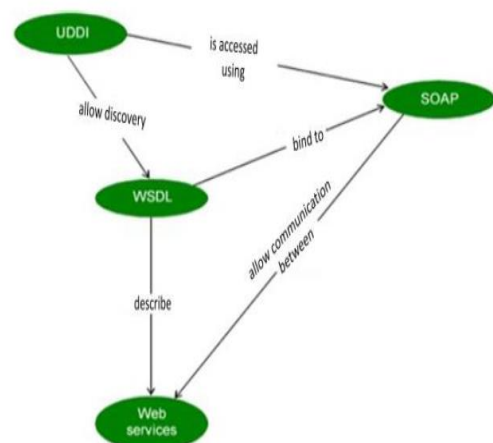

Figure 1. Basic standards of web services and the links between them [13]

Extensible Markup Language (XML) is the standard for sharing information on the web. XML is a markup language, which involves using tags that "mark" the content of a document and thus describe the content of the document. The XML tag identifies the information in the document and identifies the information structure.

Simple Object Access Protocol (SOAP) is an XML-based protocol for sharing information in a distributed environment. Provides a common message format for exchanging information between clients and services. The role of SOAP is to encode data into XML format and enable XML messaging between applications. A request-response model is used, where the request is made by a "SOAP client" and the response is provided by a service provider, called a "SOAP server". The protocol is used to send and receive messages from web services. [13]

The basic item of transmission in SOAP is a SOAP message, which consists of a mandatory SOAP envelope, an optional SOAP header, and a mandatory SOAP body. [23]

Figure 2 shows the structure of the SOAP message.

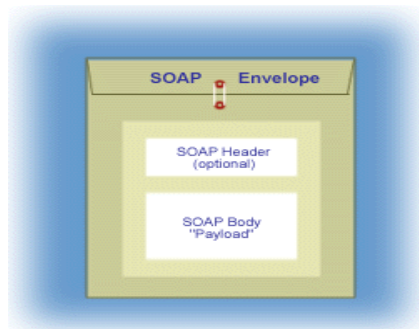

Figure 2. Structure of the SOAP [23]

Web Service Description Language (WSDL) is a document used to describe web services in terms of features, functions, and binding mechanisms when interacting with other software components. When a web service is implemented, it must make decisions at all levels about which network, transport, and packaging protocols will be supported. The description of that service represents those decisions in such a way that the service user can contact and use the service. [14]

Universal Description, Discovery, and Integration (UDDI) specifications define how information about services in the registry is published and disclosed. The UDDI registry provides service information such as the name of the service, a brief description of what it is doing, the address where the service can be accessed, and a description of the service access interface. [12]

#### IV. WEB SERVICES

Web service is a software system identified by a Uniform Resource Identifier (URI), whose public interfaces and bindings are defined and described by XML. Its definition can be discovered by other software systems. These systems can then communicate with the web service in the manner prescribed by its definition, using XML-based messages transmitted by Internet protocols. [24]

One of the most significant features of web services is interoperability. The key to enterprise interoperability lies in the interoperability, collection and sharing of data across applications. The greatest barrier to interoperability is represented by heterogeneous applications. Heterogeneity can be reflected in the fact that they are written in different programming languages, are intended for use on different operating systems, or that they use heterogeneous communication networks and data transfer methods. [25]

#### V. OVERVIEW OF WEB SERVICE SECURITY STUDIES, SECURITY RISKS, THREATS AND COUNTERMEASURES

Due to the variety of protocols and frameworks involved in web service development, they become vulnerable to attack. Although website and web service traffic can be treated similarly, the potential for security vulnerabilities is much greater with web services, as they expose critical application interfaces and operations and make them accessible through HTTP traffic.

Web service attacks can be classified into three main classes:

- Infrastructure attacks - attacks related to web servers hosted by web services, as well as attacks related to the transport protocols used to exchange web service requests.
- Web Services Attacks - originally based on real technology that runs web services.
- XML Content Attacks - which can be any type of XML-based content-based threats that use the tactic of embedding malicious content into legitimate XML documents. [15]

##### A. Denial of Services

DoS attacks affect the availability of the service and its resources to valid users. The attacker tries to prevent the authorized user from accessing the services provided by the service provider by sending a large amount of requests to the server, thus creating more network traffic and disconnecting the device. [6]

Sending extremely large XML documents to a web service can be considered a type of DoS attack. Parsing a very long XML document by a DOM (Document Object Model) XML parser can result in a huge

memory footprint and significantly reduce the resources available to service requests. The obvious attack vector is the input of large XML files that consume server-side resources during parsing, leading to DoS attacks. [7]

The countermeasure for this type of attack is to limit the total buffer size for incoming SOAP messages. In this case, it is sufficient to check the actual size of the message and reject the message that exceeds the predefined limit.

#### B. WSDL scanning

Web services can be attacked by adding WSDL to the end of the service URL, which will reveal the WSDL file. The browser will typically index WSDL files along with other files within the domain. Using cleverly created search queries, attackers can find these files. [7] [21].

One way to reduce the security risks that may arise from using information about WSDL files is not to make WSDL files publicly available. The potential for attack can be significantly reduced by simply removing any indication of the type of software infrastructure used by the web service. Information that identifies any part of the system infrastructure through headers and error codes returned to client applications must be eliminated or concealed. [7] [21]

#### C. SOAP action spoofing

Each web service request contains some type of operation that is later executed by the application logic. This operation can be found in the first subordinate element of the SOAP body. However, if HTTP is used to convey a SOAP message, the SOAP standard allows the use of an additional HTTP header element called SOAPAction. This header element contains the name of the operation performed. It should inform what operation is in the SOAP body without having to do any XML parsing. [22]

An attack can be realized by an attacker and attempt to invoke an operation different from that specified in the SOAP body, since certain web service frameworks specify an operation that will only be performed on information contained in the SOAPAction attribute. It is based on a modification of the HTTP header.

We assume that we have a web service vulnerable to SOAPAction Spoofing with the two operations "createUser" and "deleteAllUsers". Furthermore the web service is protected by a gateway, stopping all "deleteAllUsers" calls. The "createUser" operation can be executed by anyone. The "deleteAllUsers" can only be executed by authorised users who are directly connected to the web service without the gateway in between. [22]

Listing 1 shows a regular SOAP message calling for the creation of a new user. [22]

*Listing 1*

```
POST /service HTTP/1.1
Host: myHost
SOAPAction: "createUser"
<Envelope>
<Header />
<Body>
<createUser>
                                <login>johndoe</login>
                                <pwd>secret</pwd>
</createUser>
</Body>
</Envelope>
```

Listing 2 shows the same message modified by the attacker. The SOAP message passes the gateway since it only checks for the operations within the SOAP Body. The web service itself then executes the "deleteAllUsers" operation since he bases his decision solely on the operation given in the SOAPAction header. [22]

*Listing 2*

```
POST /service HTTP/1.1
Host: myHost
SOAPAction: "deleteAllUsers"
<Envelope>
<Header />
<Body>
                                <createUser>
<login>johndoe</login>
                                <pwd>secret</pwd>
                                </createUser>
</Body>
</Envelope>
```

The countermeasure is to specify the operation by the content of the SOAP body, in addition the operations specified by the HTTP header and the content of the SOAP body must be compatible and any difference should be considered a threat and the result of rejection of the web service request. [8]

#### D. XML injection

During XML injection, the attacker attempts to insert different XML tags into the SOAP message in order to modify the XML structure. Depending on the operation performed, various security objectives may be violated.[21]

Protection from XML injection should ensure that user input is properly managed and controlled before being allowed to access the main program code. The best approach is that all user entries are considered unsafe and properly monitored.

#### E. Xpath injection

XPath is a standard language, a simple descriptive expression that allows XML queries to locate information. XPath Injection is an attack technique used to exploit applications that construct XPath queries from user input or to navigate an XML document. XPath Injection attacks occur when a

website uses the information provided by a user to construct an XPath query for XML data. By sending intentionally malformed information to a web page, a malicious user can find out how XML data is structured or access restricted data from an XML data source, bypassing authentication. In some cases, the parameters within the SOAP body are directly used as input for the XPath query. If the user input is not valid, the attacker can modify the XPath query as he wishes, in the worst case the attacker can read the entire XML document requested. [18]

The most common ways to prevent attacks are strong validation and use of parameterized XPath queries. It is necessary to ensure that the application accepts only legitimate input. Query interception involves intercepting an XPath statement that is generated at run time, the generated expression is executed in the XML data warehouse, and results are obtained. In order to detect injection vulnerability, this dynamically generated expression must be intercepted. By scanning XPath expressions, queries generated at runtime can be intercepted before they are executed. In this module, XQuery intercepts are analyzed and input parameters are obtained to detect possible injections. [18]

## VI. WEB SERVICES SECURITY STANDARDS AND TECHNOLOGIES

### A. *SSL and TLS*

These are cryptographic security protocols used to ensure secure network communication. Their main goals are to provide data integrity and privacy in communication. The SSL protocol was the first protocol designed for this purpose, and TLS is its successor.

SSL uses a combination of secret key and public key cryptography for secure communication. SSL traffic uses secret keys for encryption and decryption, and public key exchange is used for mutual authentication of parties involved in communication. [27]

### B. *XML encryption and XML signature*

A combination of XML signatures and XML encryption is used to guarantee the security of using XML as a medium of information exchange, especially sensitive information described in XML.

XML encryption is a specification developed by the World Wide Web (W3C) consortium and contains steps for encrypting data, decrypting data, XML syntax to represent encrypted data, information to be used to decrypt data, and a list of encryption algorithms. XML encryption can be applied to an XML element, XML element content, and arbitrary data, including an XML document. [30]

XML signature is a recommendation of W3C, in which digital signatures are optimized for XML documents, to ensure the integrity of XML data during

the signature and/or verification process. An XML signature supports any type of digital signature encryption using all possible standard encryption algorithms. [17]

XML encryption is used to ensure that only the authorized recipient can understand the message, and an XML signature is used to ensure that the information received is in the same format as it was sent, without modification. XML encryption ensures user authentication, authorization, integrity and confidentiality. [17]

### C. *WS Security*

WS-Security is a message-level standard that is based on providing SOAP messages via XML digital signature, confidentiality through XML encryption, and credential propagation through security tokens. The Web Services Security Specification defines the facilities for protecting the integrity and confidentiality of the message and provides mechanisms for linking security-related requirements to the message. WS-Security does not require a special type of security token. It is designed to be expandable to support multiple formats of security tokens. WS-Security also describes how to encrypt binary security tokens and how to attach them with SOAP messages. With message-level security, the SOAP message itself contains either the information needed to provide the message or contains information about where to get that information to meet security needs. The SOAP message also contains information relevant to the protocols and procedures for processing the specified security at the message level. [26]

The client adds to the SOAP message header the security information related to that particular message. When a message is received, the web service endpoint, using the header security information, checks and validates the security message. [26]

WS-Security contains profiles that specify how to insert different types of binary and XML security tokens into WS-Security headers for authentication and authorization purposes.

UserName defines how a web service user can provide a username as an authentication credential. The UserName token contains basic authentication information. The username and token element extends the username and password information to authenticate the message. [27]

The <UserName> element containing the username is used in the identity statement.

Within <wsse:UsernameToken> element, a <wsse:Password> element may be specified. Passwords of type PasswordText and PasswordDigest. Having a type of PasswordText merely implies that the information held in the password is “in the clear”, as opposed to holding a “digest” of the information. [16]

Two optional elements are introduced in the <wsse:UsernameToken>element to provide a countermeasure for replay attacks: <wsse:Nonce>and <wsu:Created>. A nonce is a random value that the sender creates to include in each UsernameToken that it sends. Although using a nonce is an effective countermeasure against replay attacks, it requires a server to maintain a cache of used nonces, consuming server resources. Combining a nonce with a creation timestamp has the advantage of allowing a server to limit the cache of nonces to a "freshness" time period, establishing an upper bound on resource requirements. If either or both of <wsse:Nonce> and <wsu:Created> are present they must be included in the digest value as follows:

*Password\_Digest=Base64(SHA-1(nonce+created+password))*

That is, concatenate the nonce, creation timestamp, and the password, digest the combination using the SHA-1 hash algorithm, then include the Base64 encoding of that result as the password (digest). This helps obscure the password and offers a basis for preventing replay attacks. [16]

Listing 3 illustrates the XML syntax of this element:

*Listing 3.*

```
<wsse:UsernameTokenwsu:Id="Example-a">
<wsse:Username>...</wsse:Username>
<wsse:Password Type="...">...</wsse:Password>
<wsse:NonceEncodingType="...">...</wsse:Nonce>
<wsu:Created>...</wsu:Created>
</wsse:UsernameToken>
```

To prevent replay attacks, three countermeasures are recommended: discard all UsernameTokens that do not use nonce and timestamp; provide a timestamp limit; e.g. five minutes can be used as a minimum to detect, and therefore reject, that the used items are cached for a period at least as long as the timestamp is limited, and that UsernameToken with nonce already used is rejected. [29]

An X.509 digital certificate is a signed data structure designed to send a public key to a receiving party. A certificate includes standard fields such as certificate ID, issuer's Distinguished Name (DN), validity period, owner's DN, owner's public key. Certificates are issued by certificate authorities (CA). A CA verifies an entity's identity and grants a certificate, signing it with the CA's private key. The CA publishes its own certificate which includes its public key. [27]

To protect an XML message with an X.509 token, a contract that is specified in a WSDL must be created first. The web service must have a WS-Security policy included in the WSDL file. The WS-Policy framework allows you to specify policy information that can be

processed by web service applications. A policy is expressed as one or more policy statements that represent the capabilities or requirements of the web service. For example, a policy statement may require that a web service request be encrypted. Likewise, a policy claim can define the maximum message size a web service can accept. WS-Security Policy claims describe how messages are secured on the communication path. [27]

Kerberos token is a cross-platform authentication and single sign-on system. The Kerberos protocol provides mutual authentication between two entities relying on a shared secret (symmetric keys). Kerberos involves a client, a server, and a trusted party to mediate between them called the Key Distribution Center (KDC). [27]

KDC contains all the authentication parameters of all entities in the Kerberos system and is based on the master/slave architecture. User passwords are never sent over the network in plain text, but use special encrypted messages (tickets) for this purpose. They are generated by a KDC server at the request of a user who wants to access a particular resource in a Kerberos system.

Single-sign-on functionality means a process in which the user logs in to the system only once and is then allowed to access all Kerberos-enabled network services. [25]

Each entity of the Kerberos system, whether it is a user, a network service, or something else, is described by a specific name in the KDC server database, called a principal. Each principal uniquely describes an entity in the Kerberos system and has a corresponding structure defined by the protocol specification. Also, each principal has a secret key that is known to the KDC server and the entity whose key it is. This secret key is used to encrypt messages in the authentication process. [35]

Kerberos tickets have two basic functions, to validate the identity of an entity that requires access to a particular resource, and to establish a session key that will be used to encrypt data during communication. The timestamp and the duration of the ticket protect the system from attacks in which an unauthorized user uses previously recorded network traffic for the purpose of unauthorized access to the system. Each user request contains a timestamp generated by the client's computer when the request is formed. After accepting the request, the KDC server compares the local time with the timestamp in the request received and checks the time difference with the maximum allowed which is five minutes / initial. If not, the request is denied. All tickets issued by the Kerberos server contain the duration of the ticket in which it can be redeemed. When this time expires, the ticket is no longer available. [35] [36]

SAML is an open standard that allows identity providers to pass authorization to service providers. This means that one set of credentials can be used to log on many different websites. SAML transactions use XML for standardized communication between identity providers and service providers. SAML is the link between authentication of identity and authority to use the service. SAML allows single sign-on, meaning users can sign in once and use those credentials to sign in to other web services. [28]

When a user logs in to a SAML enabled application, the service provider requests authorization from the appropriate identity provider. The identity provider authenticates the user's credentials and then returns the user's authority to the service provider and the user can then use the application. SAML authentication is the process of verifying user identity and credentials. The SAML authorization informs the provider of what access to grant to the authorized user. [28]

#### *D. WS-Trust*

The WS-Trust refers to a specification that is defined specifically to control the issuance, renewal, and validation of web security tokens. WS-Trust is an extension of WS-Security and provides a framework for secure communication between various web applications. It is also responsible for ways to create a secure channel between participants before messaging can take place. WS-Trust describes the main methods for facilitating secure messaging. The two communicating parties must exchange security credentials directly or indirectly in order to initiate secure messaging. Each party must know that the other party is credible. [33]

#### *E. WS-Secure Conversation*

WS-SecureConversation, is a specification that provides secure communication web services session keys. WS-SecureConversation works by defining and implementing an encryption key to be shared among all the entities involved in a communications session. The originating entity defines the encryption algorithm and generates the key, which is embedded in a SOAP message. When the intended destination entities receive the message, they decrypt it and retrieve the session key, which can then be used to facilitate secure communications for the remainder of that session. [34]

Web Services Secure Conversation provides a secured session for long running message exchanges and leveraging of the symmetric cryptographic algorithm. Session-based security optimizes long message exchanges, as symmetric cryptography can be used to sign and encrypt the message. The symmetric cryptographic algorithm also provides a means of securing other session-based protocols and exchange patterns.

#### *F. WS-Addressing*

WS-Addressing provides a transport-neutral mechanism to address web services and their associated messages. Using WS-Addressing, endpoints are uniquely and unambiguously defined in the SOAP header. [32]

WS-Addressing defines two interoperable constructs that transmit information that is typically provided by transport protocols and messaging systems. These constructs normalize this basic information into a unique format that can be processed independently of transport or application. The two constructs are endpoint references and message information headers.

A web service endpoint is an entity, processor, or resource that can be targeted by web service messages. Endpoint references convey the information needed to identify/reference a web service endpoint. Endpoint references are suitable for transmitting information needed to access a web service endpoint, but are also used to provide addresses for individual messages and from web services. [31]

#### *G. WS-Reliability*

The Web Services Reliability (WS-Reliability) is a generic and open model for ensuring reliable message delivery for Web Services. It defines reliable message delivery as the ability to guarantee message delivery to software applications - web services or web service client applications - with a chosen level of quality of service (QoS). QoS is defined as the ability to determine the following aspects of message delivery: message persistence, message acknowledgement and resending, elimination of duplicate messages, ordered delivery of messages, delivery status awareness for sender and receiver applications. [37]

#### *H. WS-Reliable Messaging*

The key to WS-RM is the concept of a sequence. A sequence in WS-RM is a contract between a web services client and a web services provider, through which they agree to reliably transmit messages between them. The sequence is used to maintain the state of messages that have been sent and received. The sequence itself is specific to a provider's endpoint. When a client sends a message to a web service provider's endpoint for the first time, a sequence to that provider's endpoint is created, and all subsequent messages from that client to that provider's endpoint are delivered on that sequence. The sequence allows client-side and provider-side WS-RM to decide whether application messages need to be delivered again, and to detect whether arriving messages are duplicates. [38]

## VII. CONCLUSION

This paper explores the security aspects, techniques, and methods of deploying web services within distributed information systems. Specific security techniques and methods are also provided to ensure the

secure implementation of web services in applications and to secure the distribution of data. Further research related to the security of web service deployment in business applications could relate to new security methods and techniques, as well as the implementation of security tokens, encryption methods and electronic certificates, as well as web service security testing tools and methods that are not realized in this paper.

#### REFERENCES

- [1] W. Stallings, L. Brown: *Computer Security Principles and Practice*, UNSW Canberra at the Australian Defence Force Academy, Pearson, 2015.
- [2] W. Stallings: *Cryptography and network security Principles and Practice*, Pearson, 2017.
- [3] D. Dobrilović: Basic terms in protection of data and computer networks (In Serbian: Osnovni pojmovi zaštite sigurnosti podataka računarskih mreža), Tehničkufakultet Mihajlo Pupin, Zrenjanin, lecture notes.
- [4] P. Oscarson: *Information Security Fundamentals*, Research, In: C. Irvine et al. (eds.), Security Education and Critical Infrastructures © Springer Science+Business Media New York 2003.
- [5] M. T. Khan: *Network Security Mechanisms and Cryptography*, International Journal of Computer Science and Mobile Computing, Vol.6 Issue.7, July-2017, pg. 138-146
- [6] Lomte S. S et al. Survey of Real Case Studies of Various Network Based Attacks Indifferent Clouds. *Int J Recent Sci Res.* 9(11), pp. 29545-29556, 2018
- [7] N. Bhalla, S. Kazerooni, *Web services vulnerabilities*, Security Compass, February 2007.
- [8] M. Jensen, N. Geruscka, R. Herkenhoner: *A Survey of Attacks on Web Services, Classification and Countermeasures*, Journal "Computer Science – Research and Development", available at: <https://pdfs.semanticscholar.org/0e8f/b5bc41bd35c69c6b5d1e2f7464f0ee87e7fd.pdf>
- [9] A. S. Tanenbaum, M. Van Steen: *Distributed Systems: Principles and Paradigms*, Pearson, 2007.
- [10] Lj. Kazi et al: *Technologies of distributed information systems*, (In Serbian: Tehnologije distribuiranih informacionih sistema), Tehničkufakultet Mihajlo Pupin, lecture notes
- [11] G. Coulouris, J. Dollimore, T. Kindberg, G. Blair: *Distributed systems Concepts and Design*, Pearson, 2011.
- [12] A. D. Kshemkalyani, M. Singhal: *Distributed Computing: Principles, Algorithms and Systems*, Cambridge University Press, 2008.
- [13] S. Dumitra, B. Vasilcius: *Securing Web Services using Service Token Security*, Journal of Mobile, Embedded and Distributed Systems, vol.VI, no.2, 2014, ISSN 2067-4074
- [14] D. Tidwell, J. Snell, P. Kulchenko: *Programming Web Services with SOAP*, O'Reilly, 2001.
- [15] A. Mohsin, S. Asghar, T. Naeem: *Intelligent security cycle: A rule based run time malicious code detection technique for SOAP messages*, IEEE 19th International Multi-Topic Conference (INMIC), 2016.
- [16] *Web services Security UsernameToken Profile 1.1*, OASIS Public Review Draft, 2005, Available at: <https://www.oasis-open.org/committees/download.php/13392/wss-v1.1-spec-pr-UsernameTokenProfile-01.htm>
- [17] K. Saravanan, G. Abraham, K. Venkatasubramanian, K. Borasia: *Securing Web Services Using XML Signature and XML Encryption*, Cornell University, March 2013, available at: <https://arxiv.org/abs/1303.0910>
- [18] V. Shanmughaneethi, R. Ravichandran, S. Swamynathan, *Preventing XPath Injection Vulnerabilities in Web Applications*, International Journal of Web Service Computing, Vol.2, No.3. September 2011.
- [19] *Fundamental Security Concepts*, available at: <https://cryptome.org/2013/09/infosecurity-cert.pdf> accessed: 14.04.2019
- [20] *Types of Security Attacks and Threats*, available at: <https://flylib.com/books/en/2.87.1.77/1/> accessed: 08.05.2019
- [21] *XML Injection*, available at: [http://ws-attacks.org/XML\\_Injection](http://ws-attacks.org/XML_Injection) accessed: 06.05.2019
- [22] *SOAPAction Spoofing*, available at: [https://www.ws-attacks.org/SOAPAction\\_Spoofing](https://www.ws-attacks.org/SOAPAction_Spoofing) accessed: 09.05.2019
- [23] E. Ort: *Service-Oriented Architecture and Web Services: Concepts, Technologies and Tools*, available at: <https://www.oracle.com/technetwork/articles/javase/wsprotocols-136863.html> accessed: 14.05.2019
- [24] *Web of Services*, available at: <http://www.w3.org/standards/webofservices/> accessed: 13.05.2019
- [25] *Internet technologies, Creating web applications, XML and web services* (In Serbian: Kreiranje Vebaplikacija, XML i Vebservisi), lecture notes, available at: [http://ttl.masfak.ni.ac.rs/21IT/Predavanje\\_4\\_INTERNET\\_WEB\\_aplikacije.pdf](http://ttl.masfak.ni.ac.rs/21IT/Predavanje_4_INTERNET_WEB_aplikacije.pdf) accessed: 13.05.2019
- [26] *WS-Security*, IBM, available at: [https://www.ibm.com/support/knowledgecenter/en/SSMKHH\\_10.0.0/com.ibm.etools.mft.doc/ac55630.html](https://www.ibm.com/support/knowledgecenter/en/SSMKHH_10.0.0/com.ibm.etools.mft.doc/ac55630.html) accessed: 25.05.2019
- [27] *Fusion Middleware Security and Administrator's Guide for Web Services*, Oracle Help Center, available at: [https://docs.oracle.com/cd/E17904\\_01/web.1111/b32511/standards.htm#WSSEC1117](https://docs.oracle.com/cd/E17904_01/web.1111/b32511/standards.htm#WSSEC1117) accessed: 18.05.2019
- [28] *What is SAML*, Varonis, available at: <https://www.varonis.com/blog/what-is-saml/> accessed: 25.05.2019
- [29] *Using Username Token and SSL*, available at: <http://www.setgetweb.com/p/WAS70/ws-security/part2.html> accessed: 25.05.2019
- [30] *XML encryption*, IBM, available at: [https://www.ibm.com/support/knowledgecenter/en/SAW57\\_8.5.5/com.ibm.websphere.nd.multiplatform.doc/ae/cwbs\\_encryptv6.html](https://www.ibm.com/support/knowledgecenter/en/SAW57_8.5.5/com.ibm.websphere.nd.multiplatform.doc/ae/cwbs_encryptv6.html) accessed: 21.05.2019
- [31] *Web services addressing, W3C*, available at: <https://www.w3.org/Submission/ws-addressing/> accessed: 29.05.2019
- [32] *Fusion Middleware Programming Advanced Features of JAX-WS Web Services for Oracle WebLogic Server*, available at: [https://docs.oracle.com/cd/E24329\\_01/web.1211/e24965/wsaddressing.htm#WSADV664](https://docs.oracle.com/cd/E24329_01/web.1211/e24965/wsaddressing.htm#WSADV664) accessed: 29.05.2019
- [33] *Web Services Trust Language (WS -Trust)*, available at: <https://www.techopedia.com/definition/13712/web>

- services-trust-language-ws-trust                      accessed:  
29.05.2019
- [34]WS-Secure Conversation (Web Services Secure  
Conversation Language) available at:  
<https://searchsoftwarequality.techtarget.com/definition/WS-SecureConversation>accessed: 29.05.2019
- [35] Kerberos authentication (In Serbian: Kerberos  
autentifikacija),                      available                      at:  
[https://imi.pmf.kg.ac.rs/imi-blog/kerberos-  
autentifikacija-prvi-deo/](https://imi.pmf.kg.ac.rs/imi-blog/kerberos-autentifikacija-prvi-deo/)accessed: 27.05.2019
- [36] Kerberos Authentication Explained, Varonis,  
available at: [https://www.varonis.com/blog/kerberos-  
authentication-explained/](https://www.varonis.com/blog/kerberos-authentication-explained/)accessed: 29.05.2019
- [37] Web Services Reliability, available  
at:[https://www.service-architecture.com/articles/web-  
services/web\\_services\\_reliability\\_ws-  
reliability.html](https://www.service-architecture.com/articles/web-services/web_services_reliability_ws-reliability.html)accessed: 30.05.2019
- [38] WS-Reliable Messaging, IBM, available at:  
[https://www.ibm.com/support/knowledgecenter/en/SS  
MKHH\\_9.0.0/com.ibm.etools.mft.samples.wssecsam  
p.doc/doc/ws\\_rm\\_introduction.html](https://www.ibm.com/support/knowledgecenter/en/SSMKHH_9.0.0/com.ibm.etools.mft.samples.wssecsamp.doc/doc/ws_rm_introduction.html)                      accessed:  
30.05.2019
- [39]Definition of Authorization, The Economic Times,  
available                      at:  
[https://economictimes.indiatimes.com/definition/auth  
orization](https://economictimes.indiatimes.com/definition/authorization)accessed: 16.06.2019



# Empowering Teachers By Artificial Intelligence –Pedagogical Agents and Chat-bots

M. Bhatt<sup>1</sup>, S. Bhatt<sup>1</sup>, N. Bhatt<sup>2</sup>, Lj. Kazi<sup>3</sup> and V. Ognjenović<sup>3</sup>

<sup>1</sup>Pragat Consultancy Services – Mumbai, India

<sup>2</sup>Wipro Ltd., London, U.K.

<sup>3</sup> University of Novi Sad, Technical Faculty „Mihajlo Pupin“, Zrenjanin, Serbia

mmbhatt@gmail.com, sneha.bhatt@gmail.com, nikita.bhatt@gmail.com,  
ljubica.kazi@hotmail.com, visnjaognjenovic@gmail.com

**Abstract - It is impossible for the teacher to focus on every student in class. Artificial Intelligence can make help teachers and students to improve the educational process. Aim of this paper is to analyze possibilities of using artificial intelligence solutions in teaching and learning process. Particular focus has been set to analyzing pedagogical agents and chat-bots.**

## I INTRODUCTION

To many of us, Artificial Intelligence (AI) is not more than a buzzword or a playful application like Siri<sub>1</sub> and Alexa<sub>2</sub>. However, real life applications of Artificial Intelligence (AI) are emerging. An importance of artificial intelligence in our life, have gained momentum in recent years [1] [2] [3]. The very idea is to create AI solutions to make the lives of humans easier [2]. In aim to transform AI concepts from just a research area to reality and market [4], it has been emphasized that many countries (especially India) need startup companies that deal with deep technologies, such as AI [5]. It is obvious that using AI improves the success of a country [5], since it improves integration and analysis of data, as well as decision making. [3]

One of very important aspects of applying artificial intelligence solutions is education. AI will be very useful in education in coming years as it can do useful tasks like automating grading, solving problems in real time, analyzing and keep a track on student's performance etc. One of possible solutions is using pedagogical agents. An important aspect of designing pedagogical agents is to carefully design their role within the learning environment to serve the intended educational purposes. It is thus necessary that the agent roles are able to help the students achieve success in their learning process.

This paper presents a brief review of advantages and disadvantages of general using artificial intelligence

solutions, with particular focus on applications in teaching and learning.

## II ARTIFIFIAL INTELLIGENCE BACKGROUND

Prof. John McCarthy, the father of Artificial Intelligence, has defined the term at Dartmouth conference in 1956 as “*the science and engineering of making intelligent machines, especially intelligent computer programs*” [6].

AI development has begun with an intention of developing intelligence in machines similar to that of humans. [7] “Artificial intelligence is the sciences of making machines do things that would require intelligence. AI is concerned with two ideas – first, it involves studying the thought processes of humans; second, it deals with representing those processes via machines.” [8]

The main focus of AI is to bring in advancement to computer functions associated with human intelligence, which includes reasoning, learning, and problem-solving. Even more, “researchers of artificial intelligence want to bring in the emotional quotient to the machines along with the general intelligence.” [9]

What Contributes to AI? As per the definition of AI, it is the science and technology which are based on Computer Science, Biology, Psychology, Linguistics, Mathematics, and Engineering. “Artificial intelligence is complex in nature. It uses very complicated mixture of computer science, mathematics and other complex sciences.” [9]

Complex programming helps machines replicate and even improve the cognitive abilities of human beings [9]. “The experts predicted networked artificial intelligence will amplify human effectiveness but also threaten human autonomy, agency and capabilities. They spoke of the wide-ranging possibilities; that computers might match or even exceed human

intelligence and capabilities on tasks such as complex decision-making, reasoning and learning, sophisticated analytics and pattern recognition, visual acuity, speech recognition and language translation. They said “smart” systems in communities, in vehicles, in buildings and utilities, on farms and in business processes will save time, money and lives and offer opportunities for individuals to enjoy a more-customized future.” [10]

## **II ARTIFICIAL INTELLIGENCE, KNOWLEDGE MANAGEMENT AND ACTIVE LEARNING**

Some of the “properties of knowledge in the real world are:

- The volume is huge, beyond unimaginable,
- Not in an organized or proper format,
- It regularly undergoes changing.” [9]

According to [9], “The AI technique is a process to format and use the knowledge effectively:

- The knowledge should be graspable,
- Must be easily adaptable to correct errors,
- Can be used efficiently even if it is incomplete.”

Nowadays, one of the major challenges in education is to “improve both instructional productivity and learning quality for a large and diverse population of students under real-world constraints such as limited financial resources and insufficient numbers of qualified instructors. Many researchers suggest that students who are actively engaged in the learning process are more likely to achieve success.” [11]

Modern technologies enable students to actively participate in the learning and teaching to [12]:

(1) *Expand learning experience.* We can give the students the change to communicate with their classmates or with other people (via Web, email...) to help them answer a focused question or find solutions for a problem.

(2) *Take advantage of the power of interaction.* There are four modes of learning: dialogue with self, dialogue with others, observing and doing. Each of the four modes has its own value, and using them at the same time can add variety, and thereby be more interesting to the learners.

(3) *Create a dialect between experience and dialogue.* New experience (of doing or observing) can give learners a new perspective on what is true (beliefs) and/or what is good (values) in the world. Dialogue (with self or with others) can help learners construct the many possible meanings of experience and the insights that come from them. People learn faster when new concepts are useful in their present as well as future lives. The role of an educator is to assess the audience’s interests, current skills, and aims. This information then guides the structuring of a learning atmosphere and selection of methods most satisfying and effective for the learners.

## **III ADVANTAGES AND DISADVANTAGES OF ARTIFICIAL INTELLIGENCE**

Some of the most important advantages and disadvantages of creating and using artificial intelligence are described in [9].

Advantages of AI are:

- Error reduction, by replacing human work that is error prone,
- Aid in areas of difficult exploration for humans,
- Could be used in daily applications, with no breaks and for repetitive jobs,
- Could be used as digital assistants.

Disadvantages of AI are:

- High cost of creating AI solutions,
- Still could not perform at the level of replicating humans,
- Insufficient self-adaptation and self-improvements with “experience”,
- Could not perform with “original creativity”,
- Could cause unemployment among humans.

Having many technology and social-related issues that arise for the development and usage of AI, there are many associations that promote research and development in this area, such as the Association for the advancement of artificial intelligence [13].

## **IV INTELLIGENT AGENTS IN EDUCATION**

One particular area of AI development is directed towards agent-based systems. Software agent [14] could be defined as: “An agent is a computer system situated in some environment, capable of taking independent action on behalf of its user or owner to achieve objectives. This means that it knows by itself how it is to achieve its design aims; it doesn’t need to be told what to do. The users or owners will usually have different goals, so we can say that agents are computational, information processing entities.” [15]

In educational process, intelligent agents can be used as [16, 17]:

- **Agent as Expert** - Experts exhibit mastery or extensive knowledge and perform better than the average within a domain.
- **Agent as Motivator** - The Motivator suggests his own ideas, verbally encourages and stimulates the learners. The Motivator is not necessarily knowledgeable, but encourages the learner and, by asking questions, stimulates the learners to reflect on their personal experiences.
- **Agent as Mentor** - An ideal human instructor does not simply provide information but rather provides guidance for the learner to bridge the

gap between the current and desired skill levels. The agent as Mentor should demonstrate competence to the learner; at the same time, develop a social relationship to motivate the learner.

### **V PEDAGOGICAL AGENTS KEY FEATURES**

Specific type of intelligent agents applied in education is called "Pedagogical agent"[18]. There are many research results [19] and software development attempts with empirical validation, such as [20]. Particular applications are related to intelligent tutoring systems [21], web implementation [22] [23] and distance education [24].

Some of valuable pedagogical agent features include:

- Animated computer character presentation [25] [26]
- Behavior of caring for the learner's progress
- Emotion expression
- Personality
- Enthusiasm
- Including funny elements to encourage learning
- Persona effects [27] [28] such as gestures, such as gaze shifting, facial expression, and tone of voice
- Intervention on learners' progress and interest.

These features, if implemented with care, could give students the impression that these agents are aware of them and understand them. According to [27] [28], the persona effect is the strong positive effect of an animated agent on student's perception of their learning experience.

Example of PAOLE system [25] shows implementation of several crucial pedagogical intervention strategies:

- *Adapting strategy* – PAOLE agent observe and analyze behavior and outcomes of the learner and proposes different types of adaptations: content, presentation, navigation, etc.;
- *Supporting strategy* –PAOLE system provides support to the learner on demand of the learner or with initiative of the agent. Support could be related to: helping in homework, solving a problem, providing additional resources, modifying the interface, or at another level such as the emotional support;
- *Engaging strategy* -Engagement is related to offering the learner different types and levels of some content, as well as variety of activities related to the content.
- *Motivating strategy* - motivation of thbe learner could be improved by questions addressed to the learner by the agent, providing feedback, encouraging collaboration etc.

### **VI PEDAGOGICAL AGENTS ARCHITECTURE**

Devedzic & Harrer [29] [30] have proposed architectural patterns for pedagogical agents. Generally, software architectural patterns are applied as reusable models applied to common business problems and application domain.

General pedagogical agent pattern (Pattern 1) has been proposed in [5] and it has been presented at Figure. 1. Second pattern is presented at Figure 2. These patterns were abstracted out of a number of agents playing different roles in different educational settings, yet having much in common.

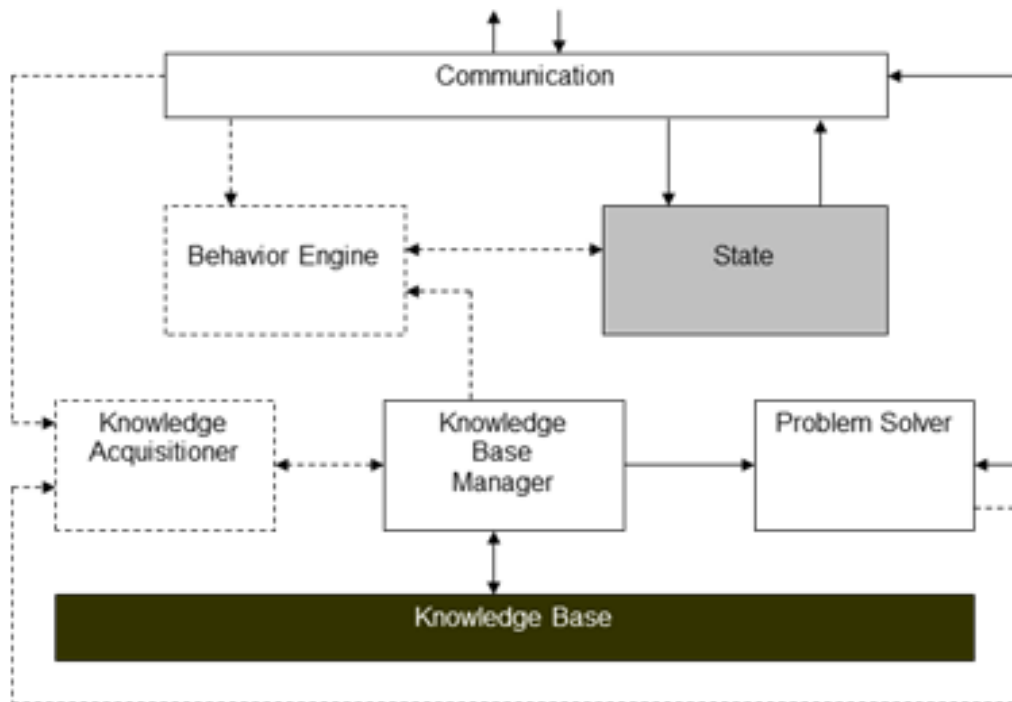

Figure 1. General Pedagogical Agent Pattern – pattern 1 [29, 30]

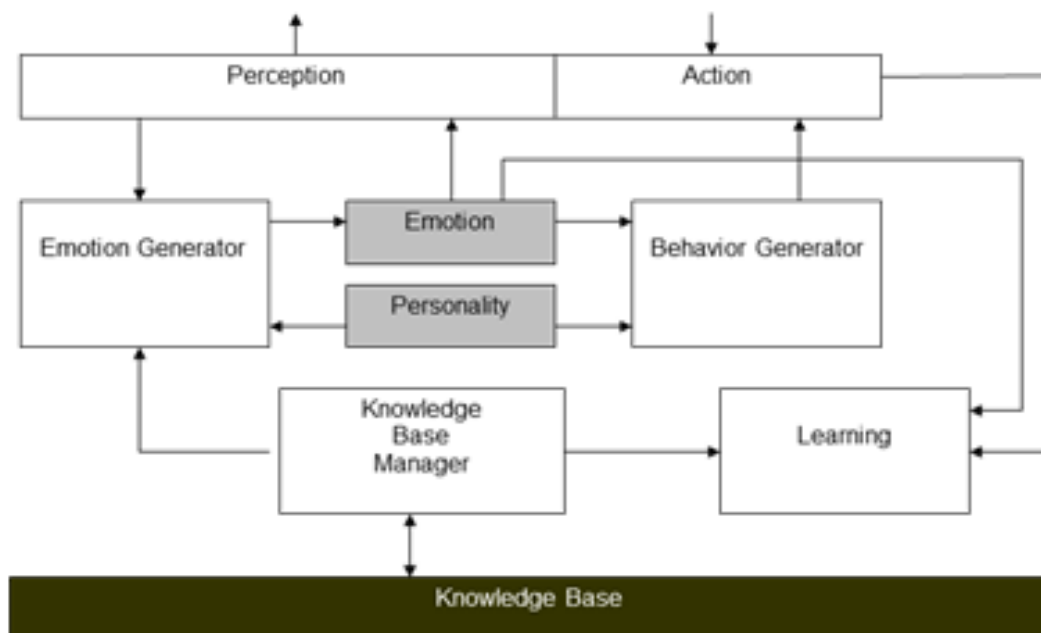

Figure 2. Second example of pedagogical agent architecture pattern – Pattern 2 [31]

Pattern 1 consists of parts[29, 30]:

- Knowledge Base Manager - includes domain knowledge, pedagogical knowledge, strategies and student models.

- Problem Solver–includes inference engine for case-based automated reasoning.
- Communication (Interface)–enables receiving data from the learning environment and presenting the processing outcome.

- “State” presents a general abstraction for many kinds of states that a pedagogical agent can be made “aware of”. It also contains parameters’ values of the agent’s relationships with other agents.
- Knowledge acquisitioner—enables receiving, update and modification of knowledge, collected over time.
- Behavior Engine (Expression Engine) is responsible for the analysis of the agent’s internal state and modification of the current state.

Pattern 2 refers to agents which are designed as students in a classroom. Important parts are [31]:

- Emotion and personality - each agent have its own personalities and emotions. Comparing to pattern 1, it is similar to instance of State.
- Learning -All kinds of problem solving activities associated with learning situations. Comparing to pattern 1, it is Problem Solver instance.

Behavior Engine is split in 2 distinct parts:

- Emotion Generator - generates the agent’s emotion
- Behavior Generator - formulates the agent’s learning actions and pass them to the effect (Action)
- Action part – makes actions (comparing to pattern 1 it is part of the Communication Module).

## VII CHAT-BOTS IN EDUCATION

One of contemporary areas of using artificial intelligence is creating chat-bots. “Chat-bots are online robots which are powered by artificial intelligence to give automated replies to text messages like humans.” [3]

One of the interesting solutions is created at Indian Institute of Technology Guwahati- chat-bot Albela[33]. Albela is designed primarily to help first-year students of Electrical and Electronic Engineering. It can help students find their class schedule and provides answers to questions related to institute, academic and administrative process and examinations. It also can give suggestions regarding preferred textbooks, reference books, notes, sample questions, etc. The ALBELA solution is based on IBM cloud, with using structured data, SQL and JSON.

## VIII. CONCLUSION

Aim of this paper was to present the overall artificial intelligence advantages and disadvantages, as well as to address the application of AI solutions to educational process. Special emphasize has been put to the general benefits of active learning benefits and knowledge management and the context is related to the use of appropriate AI tools, such as pedagogical agents and chat-bots.

There are many benefits of using artificial intelligence solutions in educational process. They are empowering teachers, since it is very difficult for any teacher to focus on every student in the classes and help teachers in routine tasks, like grading. They support students, since often students just fail to understand why they are not able to tackle a particular type of a problem and have the need for “trial and error” be exercised. It brings a dynamic and personalized approach and assistance to students. AI solutions bring helpful feedback and assistance for students and teachers, identifying weaknesses and problems, propose solutions and forecast (project) future trends. They offer customization and tailored education, educational process improvement suggestions, filling the gaps in explanations from regular classes, data acquisition and processing, preparing and adapting necessary data based on user behavior, needs and interests.

Particular focus in this paper has been given to the intelligent agents and chat bots. Pedagogical agents with animated features are particularly addressed in this paper from the functionality and architecture perspective.

It has been shown that developing pedagogical agents improve both instructional productivity and learning quality for a large and diverse population of students under real-world constraints. Future research could be focused on:

- Evaluating and analyzing the effectiveness of pedagogical agents in various learning contexts,
- Improving pedagogical agent architectures and features.

Artificial intelligence augments and empowers human intelligence. As long we are successful in keeping technology beneficial, we will be able to help this human civilization. The role of teachers is changing with the application of artificial intelligence, but their human interaction with students will not be replaced. AI solutions empower teachers, so they could be more focused on creative approach to preparing lessons and solving problems. Teachers will supplement AI-enabled lessons, assist students who are struggling and provide human interaction with hands-on experiences for students. AI will channelize teacher’s precious time into priority area that needed immediate attention, thus making their teaching more effective.

### *Abbreviations*

1. *Siri* - It is a virtual assistant that is part of Apple’s iOS, watchOS, macOS, HomePod, and tvOS operating systems.
2. *Alexa* - an echo device

## REFERENCES

- [1] AI changing the world, available at: <https://www.brookings.edu/research/how-artificial-intelligence-is-transforming-the-world/> accessed: 30.7.2019.
- [2] A. Rathi: *The impact of artificial intelligence*, available at: <https://towardsdatascience.com/the-impact-of-artificial-intelligence-8615d1d9b7ac>, accessed: 30.7.2019.
- [3] Artificial Intelligence and the Future of Humans, available at: <https://www.pewresearch.org/internet/2018/12/10/artificial-intelligence-and-the-future-of-humans/>, accessed: 30.7.2019.
- [4] *How startups can use AI-Powered Tools to scale up*, available at: <https://www.entrepreneur.com/article/337911>, accessed: 30.7.2019.
- [5] *Why India Needs Deep Tech Startups*, available at: <https://www.livemint.com/technology/tech-news/why-india-needs-deep-tech-startups-11572250462873.html>, accessed 30.7.2019.
- [6] *Definition of Artificial Intelligence*, available at: [https://aisb.org.uk/new\\_site/?p=73](https://aisb.org.uk/new_site/?p=73), accessed 30.7.2019.
- [7] Russell, S.J. and P. Norvig. "Artificial intelligence: a modern approach." *Prentice Hall series in artificial intelligence*. Prentice Hall, N.J. 1995
- [8] R. Behl: *Information Technology for Management*, Tata Mc Graw-Hill Education, 2009.
- [9] Artificial Intelligence Advantages and Disadvantages, available at: <https://content.wisestep.com/advantages-disadvantages-artificial-intelligence/>, accessed: 30.7.2019.
- [10] Deeper Look at AI technology, available at: <https://www.itechlegends.com/2017/12/a-deeper-look-at-ai-technology.html>, accessed: 30.7.2019
- [11] Sweeta, P. Dhyani, O.P. Rishi: Intelligent Tutoring System Using CASE-Based reasoning, In U.Kose, D.Koc (eds): *Artificial Intelligence Applications in Distance Education*, IGI Global, 2015.
- [12] Y. SHANG, H. SHI, S.-S. CHEN: *An Intelligent Distributed Environment for Active Learning*, ACM Journal of Educational Resources in Computing, Vol. 1, No. 2, Summer 2001, Article #4, 17 pages
- [13] Association for the advancement of artificial intelligence, available at: <http://www.aaai.org>, accessed: 30.7.2019
- [14] Nwana, H. *Software Agents: An Overview*. Knowledge Engineering Preview, Vol. 11, No. 3. Cambridge University Press. 1996
- [15] What is Multi-Agent System, available at: <https://www.doc.ic.ac.uk/project/examples/2005/163/g0516319/introdpage.html>, accessed: 30.7.2019
- [16] Baylor, A. L. Kim, Y. Validating pedagogical agent roles: Expert, Motivator, and Mentor. *ED-MEDIA*, Honolulu, Hawaii. 2003.
- [17] A.L. Baylor, K. Yanghee: *Simulating Instructional Roles through Pedagogical Agents*, available at: [https://digitalcommons.usu.edu/cgi/viewcontent.cgi?article=1065&context=itls\\_facpub](https://digitalcommons.usu.edu/cgi/viewcontent.cgi?article=1065&context=itls_facpub), accessed: 30.7.2019.
- [18] Johnson, W. L. (1998), *Pedagogical agents*. *ICCE'98 - Proceedings Sixth International Conference on Computers in Education*. China.
- [19] Tecuci, G., Keeling, H. *Developing an Intelligent Educational Agent with Disciple*. *International Journal of Artificial Intelligence in Education*, 1999.
- [20] Johnson W.L., Shaw, E., Marshall, A., & Labore, C. *Evolution of user interaction: The case of agent Adele*. *Proceedings of IUI'03*. New York: ACM Press, 2003.
- [21] Santos, C., Frozza, R., Dhameer, A., Gaspary, L. P. : *DORIS – Pedagogical Agent in Intelligent Tutoring Systems*. *Lecture Notes in Computer Science (Intelligent Tutoring Systems)*. ITS 2002
- [22] Peña, Clara-Inés. Marzo, Jose-L. Josep-Lluis de la Rosa. *Intelligent Agents in a Teaching and Learning Environment on the Web*, University of Girona, Spain. 2002.
- [23] Swan, E., Johnson, L. and Ganesham, R. *Pedagogical Agents on the Web*. *Autonomous Agents'99*, ACM Press, 1999.
- [24] ThiryM, Khator S, Barcia R.M., Martins A, *Intelligent Agent-Based Approach for Distance Learning*, *Proceedings of International Conference on Engineering Education*. 1998.
- [25] Bendou K, Megder E, Cherkaoui: *Animated Pedagogical Agents to Assist Learners and to keep them motivated on online learning environments (LMS or MOOC)*, *International Journal of Computer Applications*, Vol 168, No 6, June 2017.
- [26] Slater, D. (2000). *Interactive Animated Pedagogical Agents: An introduction to an emerging field*. ED324/G345: Stanford University. 2000
- [27] Baylor, A. L., Elbers: *The Pedagogical Agent Split-Persona Effect: When Two Agents are Better than One*, *Proceedings of ED-MEDIA*, Honolulu, Hawaii, 2003.
- [28] Lester, J. C., Converse, S. A., Kahler, S. E., Barlow, S. T., Stone, B. A., Bhoga, R. S. (1997). *The Persona Effect: Affective Impact of Animated Pedagogical Agents*. *CHI'97 - Conference on Human Factors in Computing Systems*. ACM: Electronic Publication.
- [29] Devedzic, V., Harrer, A. *Software patterns in ITS (Intelligent Tutoring Systems) architectures*, *International Journal of Artificial Intelligence in Education*, Vol 15, 2005, pp. 63-94.
- [30] Devedzic, V., Harrer, A. *Architectural Patterns in Pedagogical Agents*. *Lecture Notes in Computer Science (Intelligent Tutoring Systems)*. ITS 2002
- [31] H. Thi Thanh Ai: *Intelligent Agent in Education*, available at: <http://www.iro.umontreal.ca/~aimeur/cours/ift6261/Presntations-etudiants/Intelligent%20Agent%20in%20Education.ppt> , accessed 30.7.2019.
- [32] *AI-based chat-bot Albela*, <https://indianexpress.com/article/education/iit-guwahati-develops-chatbot-albela-to-teach-assist-first-year-students-5962097/>

# APPENDIX

## AIIT 2019 Organizing Committee

Ljubica Kazi, Technical faculty "Mihajlo Pupin", Zrenjanin, University of Novi Sad, Serbia – president  
Evgeny Cherkashin, Matrosov Institute of System Dynamic and Control Theory SB RAS, Russia  
Blagoj Ristevski, Faculty of Information and Communication Technologies, University "St. Kliment Ohridski", Bitola, North Macedonia  
Dragica Radosav, Technical faculty "Mihajlo Pupin", Zrenjanin, University of Novi Sad, Serbia  
Miodrag Ivković, Technical faculty "Mihajlo Pupin", Zrenjanin, University of Novi Sad, Serbia  
Biljana Radulović, Technical faculty "Mihajlo Pupin", Zrenjanin, University of Novi Sad, Serbia  
Ivana Berković, Technical faculty "Mihajlo Pupin", Zrenjanin, University of Novi Sad, Serbia  
Duško Letić, Technical faculty "Mihajlo Pupin", Zrenjanin, University of Novi Sad, Serbia  
Branko Markoski, Technical faculty "Mihajlo Pupin", Zrenjanin, University of Novi Sad, Serbia  
Željko Stojanov, Technical faculty "Mihajlo Pupin", Zrenjanin, University of Novi Sad, Serbia  
Dalibor Dobrilović, Technical faculty "Mihajlo Pupin", Zrenjanin, University of Novi Sad, Serbia  
Eleonora Brtko, Technical faculty "Mihajlo Pupin", Zrenjanin, University of Novi Sad, Serbia  
Dejan Lacmanović, Technical faculty "Mihajlo Pupin", Zrenjanin, University of Novi Sad, Serbia  
Vladimir Brtko, Technical faculty "Mihajlo Pupin", Zrenjanin, University of Novi Sad, Serbia  
Višnja Ognjenović, Technical faculty "Mihajlo Pupin", Zrenjanin, University of Novi Sad, Serbia  
Zoltan Kazi, Technical faculty "Mihajlo Pupin", Zrenjanin, University of Novi Sad, Serbia  
Dijana Karuović, Technical faculty "Mihajlo Pupin", Zrenjanin, University of Novi Sad, Serbia  
Ivan Tasić<sup>+</sup>, Technical faculty "Mihajlo Pupin", Zrenjanin, University of Novi Sad, Serbia  
Vladimir Šinik, Technical faculty "Mihajlo Pupin", Zrenjanin, University of Novi Sad, Serbia  
Nadežda Ljubojev, Technical faculty "Mihajlo Pupin", Zrenjanin, University of Novi Sad, Serbia  
Dušanka Milanov, Technical faculty "Mihajlo Pupin", Zrenjanin, University of Novi Sad, Serbia  
Siniša Mihajlović, Technical faculty "Mihajlo Pupin", Zrenjanin, University of Novi Sad, Serbia  
Novak Simić, Technical faculty "Mihajlo Pupin", Zrenjanin, University of Novi Sad, Serbia  
Velibor Premčevski, Technical faculty "Mihajlo Pupin", Zrenjanin, University of Novi Sad, Serbia  
Aleksandra Stojkov, Technical faculty "Mihajlo Pupin", Zrenjanin, University of Novi Sad, Serbia  
Maja Gaborov, Technical faculty "Mihajlo Pupin", Zrenjanin, University of Novi Sad, Serbia  
Milica Mazalica, Technical faculty "Mihajlo Pupin", Zrenjanin, University of Novi Sad, Serbia  
Igor Vecštejn, Technical faculty "Mihajlo Pupin", Zrenjanin, University of Novi Sad, Serbia  
Marko Blažić, Technical faculty "Mihajlo Pupin", Zrenjanin, University of Novi Sad, Serbia  
Vladimir Karuović, Technical faculty "Mihajlo Pupin", Zrenjanin, University of Novi Sad, Serbia  
Bojan Vujanov, Technical faculty "Mihajlo Pupin", Zrenjanin, University of Novi Sad, Serbia  
Anastasia Popova, Matrosov Institute for System Dynamics and Control Theory of the Siberian Branch of the Russian Academy of Sciences, Russia  
Andrijana Bocevska, Faculty of Information and Communication Technologies - Bitola, University "St. Kliment Ohridski", Bitola, North Macedonia  
Natasha Blazheska-Tabakovska, Faculty of Information and Communication Technologies - Bitola, University "St. Kliment Ohridski", Bitola, North Macedonia  
Tome Dimovski, Faculty of Information and Communication Technologies - Bitola, University "St. Kliment Ohridski", Bitola, North Macedonia  
Nikola Rendevski, Faculty of Information and Communication Technologies - Bitola, University "St. Kliment Ohridski", Bitola, North Macedonia  
Filip Tsvetanov, South-west University "Neophyte Rilsky", Faculty of Engineering, Blagoevgrad, Bulgaria

## AIIT 2019 Program Committee

Ljubica Kazi, Technical faculty "Mihajlo Pupin", Zrenjanin, University of Novi Sad, Serbia – president  
Evgeny Cherkashin, Matrosov Institute of System Dynamic and Control Theory SB RAS, Russia  
Blagoj Ristevski, Faculty of Information and Communication Technologies, University "St. Kliment Ohridski", Bitola, North Macedonia  
Dragica Radosav, Technical faculty "Mihajlo Pupin", Zrenjanin, University of Novi Sad, Serbia  
Dragana Glušac, Technical faculty "Mihajlo Pupin", Zrenjanin, University of Novi Sad, Serbia  
Borislav Odadžić, Technical faculty "Mihajlo Pupin", Zrenjanin, University of Novi Sad, Serbia (retired)  
Duško Letić, Technical faculty "Mihajlo Pupin", Zrenjanin, University of Novi Sad, Serbia  
Miodrag Ivković, Technical faculty "Mihajlo Pupin", Zrenjanin, University of Novi Sad, Serbia



**International conference on Applied Internet and Information Technologies  
October 3-4, 2019, Zrenjanin, Republic of Serbia**

---

Biljana Radulović, Technical faculty "Mihajlo Pupin", Zrenjanin, University of Novi Sad, Serbia  
Ivana Berković, Technical faculty "Mihajlo Pupin", Zrenjanin, University of Novi Sad, Serbia  
Vladimir Brtko, Technical faculty "Mihajlo Pupin", Zrenjanin, University of Novi Sad, Serbia  
Branko Markoski, Technical faculty "Mihajlo Pupin", Zrenjanin, University of Novi Sad, Serbia  
Dalibor Dobrilović, Technical faculty "Mihajlo Pupin", Zrenjanin, University of Novi Sad, Serbia  
Željko Stojanov, Technical faculty "Mihajlo Pupin", Zrenjanin, University of Novi Sad, Serbia  
Dejan Lacmanović, Technical faculty "Mihajlo Pupin", Zrenjanin, University of Novi Sad, Serbia  
Zoltan Kazi, Technical faculty "Mihajlo Pupin", Zrenjanin, University of Novi Sad, Serbia  
Višnja Ognjenović, Technical faculty "Mihajlo Pupin", Zrenjanin, University of Novi Sad, Serbia  
Eleonora Brtko, Technical faculty "Mihajlo Pupin", Zrenjanin, University of Novi Sad, Serbia  
Jelena Stojanov, Technical faculty "Mihajlo Pupin", Zrenjanin, University of Novi Sad, Serbia  
Vesna Makitan, Technical faculty "Mihajlo Pupin", Zrenjanin, University of Novi Sad, Serbia  
Nadežda Ljubojev, Technical faculty "Mihajlo Pupin", Zrenjanin, University of Novi Sad, Serbia  
Ivan Tasić<sup>+</sup>, Technical faculty "Mihajlo Pupin", Zrenjanin, University of Novi Sad, Serbia  
Dijana Karuović, Technical faculty "Mihajlo Pupin", Zrenjanin, University of Novi Sad, Serbia  
Vladimir Šinik, Technical faculty "Mihajlo Pupin", Zrenjanin, University of Novi Sad, Serbia  
Dušanka Milanov, Technical faculty "Mihajlo Pupin", Zrenjanin, University of Novi Sad, Serbia  
Ilija Hristoski, Faculty of Economics - Prilep, University "St. Kliment Ohridski", Bitola, North Macedonia  
Igor Nedelkovski, Faculty of Information and Communication Technologies, University "St. Kliment Ohridski", Bitola, North Macedonia  
Aleksandar Markovski, Faculty of Information and Communication Technologies, University "St. Kliment Ohridski", Bitola, North Macedonia  
Violeta Manevska, Faculty of Information and Communication Technologies, University "St. Kliment Ohridski", Bitola, North Macedonia  
Pece Mitrevski, Faculty of Information and Communication Technologies, University "St. Kliment Ohridski", Bitola, North Macedonia  
Ilija Jolevski, Faculty of Information and Communication Technologies, University "St. Kliment Ohridski", Bitola, North Macedonia  
Dragan Gruevski, Faculty of Information and Communication Technologies, University "St. Kliment Ohridski", Bitola, North Macedonia  
Konstadina Veljanovska, Faculty of Information and Communication Technologies, University "St. Kliment Ohridski", Bitola, North Macedonia  
Sonja Mančevska, Faculty of Information and Communication Technologies, University "St. Kliment Ohridski", Bitola, North Macedonia  
Snežana Savoska, Faculty of Information and Communication Technologies, University "St. Kliment Ohridski", Bitola, North Macedonia  
Ramona Markoska, Faculty of Information and Communication Technologies, University "St. Kliment Ohridski", Bitola, North Macedonia  
Mimoza Bogdanoska-Jovanovska, Faculty of Information and Communication Technologies, University "St. Kliment Ohridski", Bitola, North Macedonia  
Božidar Milenkovski, Faculty of Information and Communication Technologies, University "St. Kliment Ohridski", Bitola, North Macedonia  
Zoran Kotevski, Faculty of Information and Communication Technologies, University "St. Kliment Ohridski", Bitola, North Macedonia  
Nikola Rendevski, Faculty of Information and Communication Technologies, University "St. Kliment Ohridski", Bitola, North Macedonia  
Andrijana Bocevska, Faculty of Information and Communication Technologies, University "St. Kliment Ohridski", Bitola, North Macedonia  
Monika Markovska, Faculty of Information and Communication Technologies, University "St. Kliment Ohridski", Bitola, North Macedonia  
Tome Dimovski, Faculty of Information and Communication Technologies, University "St. Kliment Ohridski", Bitola, North Macedonia  
Marina Blazhekovič - Toshevski, Faculty of Information and Communication Technologies, University "St. Kliment Ohridski", Bitola, North Macedonia  
Natasha Blažeska - Tabakovska, Faculty of Information and Communication Technologies, University "St. Kliment Ohridski", Bitola, North Macedonia  
Lela Ivanovska, Faculty of Information and Communication Technologies, University "St. Kliment Ohridski", Bitola, North Macedonia  
Andrey Gachenko, Matrosov Institute for System Dynamics and Control Theory of the Siberian Branch of the

**International conference on Applied Internet and Information Technologies**  
**October 3-4, 2019, Zrenjanin, Republic of Serbia**

---

Russian Academy of Sciences, Irkutsk, Russia  
Andrey Mikhailov, Matrosov Institute for System Dynamics and Control Theory of the Siberian Branch of the Russian Academy of Sciences, Irkutsk, Russia  
Anastasia Popova, Matrosov Institute for System Dynamics and Control Theory of the Siberian Branch of the Russian Academy of Sciences, Irkutsk, Russia  
Alexey Daneev, Irkutsk State Transport University, Irkutsk, Russia  
Denis Sidorov, Melentiev Energy Systems Institute of Siberian Branch of the Russian Academy of Sciences, Irkutsk, Russia  
Viacheslav Paramonov, Matrosov Institute for System Dynamics and Control Theory of the Siberian Branch of the Russian Academy of Sciences, Irkutsk, Russia  
Andrey Dorofeev, Institute of High Technologies, Irkutsk National Research Technical University, Irkutsk, Russia  
Aleksej Stevanov, South-west University "Neophyte Rilsky", Faculty of Engineering, Blagoevgrad, Bulgaria  
Petar Apostolov, South-west University "Neophyte Rilsky", Faculty of Engineering, Blagoevgrad, Bulgaria  
Filip Tsvetanov, South-west University "Neophyte Rilsky", Faculty of Engineering, Blagoevgrad, Bulgaria  
Gogolák László, Subotica Tech - College of Applied Sciences, Subotica, Serbia  
Zlatko Čović, Subotica Tech - College of Applied Sciences, Department of Informatics, Subotica, Serbia  
Zora Konjović, University Singidunum, Centar Novi Sad, Serbia  
Siniša Nešković, Faculty of organizational sciences, University of Belgrade, Serbia  
Nataša Gospić, Faculty of transport and traffic engineering, Belgrade, Serbia  
Željko Trpovski, Faculty of technical Sciences, Novi Sad, Serbia  
Branimir Đorđević, Megatrend University, Belgrade, Serbia  
Slobodan Jovanović, Faculty of Information Technology, Belgrade, Serbia  
Diana Gligorijević, Telegroup, Serbia  
Željko Eremić, College of Technical Sciences - Zrenjanin, Serbia  
Rajnai Zoltán, Obuda University, Budapest, Hungary  
Mirjana Pejić Bach, University of Zagreb, Croatia  
Androklis Mavridis, Aristotel University of Thessaloniki, Greece  
Madhusudan Bhatt, K.C. College, University of Mumbai, India (retired)  
Amar Kansara, Parth Systems LTD, Navsari, Gujarat, India  
Narendrabhai Chotaliya, MP Shah Arts & Science College, Surendranagar, India  
Željko Jungić, ETF, University of Banja Luka, Bosnia and Hercegovina  
Sašo Tamazič, Univerisity of Ljubljana, Slovenia  
Marijana Brtko, Centro de Matemática, Computação e Cognição, Universidade Federal do ABC, São Paulo, Brazil  
Zoran Ćosić, Statheros, Split, Croatia  
Istvan Matijevics, Institute of Informatics, University of Szeged, Hungary  
Slobodan Lubura, Faculty of electrical engineering, University of East Sarajevo, Bosnia and Hercegovina  
Edit Boral, ASA College, New York, NY, USA  
Dana Petcu, West University of Timisoara, Romania  
Marius Marcu, "Politehnica" University of Timisoara, Romania

## LIST OF AIIT2019 REVIEWERS

### University of Novi Sad, Technical Faculty "Mihajlo Pupin" Zrenjanin, Serbia

Berković	Ivana
Brtka	Eleonora
Brtka	Vladimir
Dobrilović	Dalibor
Glušac	Dragana
Karuović	Dijana
Kazi	Ljubica
Kazi	Zoltan
Ljubojev	Nadežda
Makitan	Vesna
Ognjenović	Višnja
Radulović	Biljana
Stojanov	Jelena
Stojanov	Željko
Šinik	Vladimir

### South-west university "Neophyte Rilsky", Faculty of Engineering, Blagoevgrad, Bulgaria

Apostolov	Petar
Stefanov	Aleksey

### Institute of High Technologies, Irkutsk National Research Technical University, Irkutsk, Russia

Cherkashin	Evgeny
Dorofeev	Andrey

### Matrosov Institute for System Dynamics and Control Theory of Siberian Branch of Russian Academy of Sciences, Irkutsk, Russia.

Paramonov	Vyacheslav
Popova	Anastasia

### Faculty of Information and Communication Technologies – Bitola, "St. Kliment Ohridski" University – Bitola, North Macedonia

Dimovski	Tome
Ivanovska	Lela
Kotevski	Zoran

**International conference on Applied Internet and Information Technologies  
October 3-4, 2019, Zrenjanin, Republic of Serbia**

---

Markoska	Ramona
Markoski	Aleksandar
Markovska	Monika
Milenkovski	Bozhidar
Risteovski	Blagoj
Savoska	Snezhana
Blazheska - Tabakovska	Natasha
Veljanovska	Kostandina

**MP Shah Arts & Science College, Surendranagar, India**

Chotaliya	Narendrabhai
-----------	--------------

**K.C. College, University of Mumbai, India**

Madhusudan	Bhatt (retired)
------------	-----------------

(currently: Pragat Consultancy Services – Mumbai, India)

## **INVITED SPEAKERS BIOGRAPHIES**



**Prof. Dr. Abdel - Badeeh Mohamed  
Salem**

Prof. Dr. Abdel - Badeeh M. Salem is a professor emeritus of Computer Science since September 2007 till now. He was a former Vice Dean of the Faculty of Computer and Information Sciences at Ain Shams University, Cairo-Egypt (1996-2007). He was a full professor Dr. of Computer Science at Faculty of Science, Ain Shams University from 1989 to 1996. He was a Director of Scientific Computing Center at Ain Shams University (1984-1990). In 1996 he was moved to the Faculty of Computer and Information Sciences at the same university. His research includes Knowledge engineering and computing, expert systems, intelligent medical and health informatics, and intelligent e-learning technologies. He has published around 500 papers in refereed journals and conference proceedings in these areas, 91 of them are in Scopus. He has been involved in more than 500 conferences and workshops as a Keynote speaker, member of Int. Program Committees, organizer and Session Chair. He is author and co-author of 25 Books in English and Arabic Languages.

He was one of the founders of the following events: First Egyptian Workshop on Expert Systems 1987, Int. Cairo Conference on Artificial Intelligence Applications in 1992 and Int. Conf. on Intelligent Computing and Information Systems 2002, and one of the main sustainers of annual Int. Romanian Internet Learning Workshop Project (RILW), 1997. In addition he was Secretary of Egyptian Computer Society (1984-1990), Member of National Committee in Informatics – Academy of Scientific Research and Technology (1992-200), Member of Egyptian Committee in the Inter-Governmental Informatics Program, IIP-UNISCO, Paris (1988-1990) and Coordinator of the Annual International Conference for Statistics, Scientific Computing, and Social and Demographic Research (1983-1990). In addition he was a partner of a MEDCAMPUS Projects on Methodologies and Technologies for Distance Education in Mediterranean (1993-1995)

He is a member of the Editorial Board of the following Journals: Int. Journal of Computing and Information Sciences(IJCIS), Canada; Egyptian Computer Science Journal, EC Newsletter, Education in Computing and Computers in Education, Italy; Scientific Journal of Studia Universitatis Babes-Bolyai, Series Informatica, Cluj – Napoca, Romania; International Journal of intelligent computing in medical sciences and image processing (IC-MED), Japan; Egyptian Journal for Specialized Studies, Faculty of Specific Education, Ain Shams University,Egypt; Int. Journal of Intelligent Computing & Information Science”, IJCIS, Egypt; Enformatika Transactions on Engineering, Computing and Technology, World Enformatika Society, Turkey; and Int. Journal of Soft Computing Approaches (IJSCA), Eurojournals.

He is a member of Int. Scientific Societies: American Association of Artificial Intelligence (AAAI), USA; British Computer Society, Expert Systems Specialist Group (SGES), Int. Neural Network Society (INNS), USA; Association for the Advancement of Computing Education (AACE), USA; Int. Society for Computers and their Applications (ISCA, NC, USA); Int. Society for Telemedicine & eHealth ISfTeH,, Switzerland; Member of Int. Federation for Information Processing (IFIP) Technical Committee WG 12.5, Knowledge-Oriented Development of Applications, Austria, Member of Int. Association for Science and Technology for Development (IASTED), TC on AI and Expert Systems, Int. Association for Science and Technology for Development, Canada.

Dr Salem is elected member of Euro Mediterranean Academy of Arts and Sciences, Athens, Greece (EMAAS - <http://www.euromediterraneanacademy.org/>), member of Alma Mater Europaea of the European Academy of Sciences and Arts, Belgrade (<http://www.almamatereuropaea.rs>), member of European Academy of Sciences and Arts, Class VI, Salzburg, Austria (<http://www.euro-acad.eu>), and member of International Engineering and Technology Institute - (IETI) , Hong Kong (<http://www.ieti.net>).



**Kremena Stefanova, PhD**

Kremena Stefanova is head assistant professor at Department "Computer Technologies", Faculty of Mathematics and Informatics, Plovdiv University "Paisii Hilendarski", Bulgaria. Kremena Stefanova joined Plovdiv University "Paisii Hilendarski" in 2011 as an assistant professor in the department "Computer Technologies" of Faculty of Mathematics and Informatics. The topic of her PhD thesis is "Qualitative Methods for Some Special Types of Differential Equations" and she defended it in 2012. Since 2013 she works as head assistant professor and teaches disciplines related to computer science. Her h-index is 4 (according to Scopus) and she has 30 publications, 3 books, 34 citations, 26 talks on conferences and 6 participations in scientific projects as a member.



**Veselina Naneva, Mr**

Veselina Naneva is assistant professor at Department "Software Technologies", Faculty of Mathematics and Informatics, Plovdiv University "Paisii Hilendarski", Bulgaria. Veselina Naneva joined Plovdiv University "Paisii Hilendarski" in 2015 as a part-time assistant in the department "Software Technologies" of Faculty of Mathematics and Informatics. She has knowledge of object-oriented programming, the use of a variety of software platforms to administer dynamic web systems, as well as skills in working with Adobe Creative Cloud software. Since 2019 she works as assistant professor and teaches disciplines related to software development, applicable business technologies and graphic design. She has 6 publications, 8 talks on conferences and 2 participations in scientific projects as a member.



**Dinu Dragan, PhD**

Dr. Dinu Dragan was born in 1979 in Zrenjanin, Serbia. He is an Assistant Professor at the Department of Computing and Control Engineering of the University of Novi Sad, Faculty of Technical Sciences, Novi Sad, Serbia and COO of Real Market, Novi Sad, Serbia. He received Bachelor with Honors in Electrical Engineering and Computer Science in 2003, and the MSc and Ph.D. in Computer Science from the University of Novi Sad, Faculty Technical Sciences, Serbia, in 2008 and 2013, respectively. His research interests include data compression, computer graphics, human-computer interaction, data visualization, computer vision, and, of lately, fintech / regtech. He authored or co-authored more than 50 papers published in peer-reviewed journals or monographs, or presented at scientific conferences, as well as 3 technical solutions.



**Dušan Gajić, PhD**

Dr. Dušan Gajić was born in 1982 in Niš, Serbia. He is an Assistant Professor at the Department of Computing and Control Engineering of the University of Novi Sad, Faculty of Technical Sciences, Serbia, and CEO of Real Market, Novi Sad, Serbia. He received his MSc and PhD degrees in Electrical Engineering and Computing from the University of Niš, Faculty of Electronic Engineering, Serbia, in 2009 and 2014, respectively. His research interests include parallel and distributed computing, blockchain, GPGPU, algorithm design, and computer vision. He authored or co-authored 5 chapters in international scientific monographs, more than 50 papers published in peer-reviewed journals or presented at scientific conferences, as well as 2 technical solutions. He received best paper awards at ETRAN 2013 and DIPP 2015 conferences.





**Prof. dr Srđan Popov**

Srđan Popov was born in 1969 in Zrenjanin, Serbia. He completed elementary school in Zrenjanin, where he also graduated from the Koca Kolarov Secondary School for Social Affairs, majoring in mathematics. He completed his basic studies at the Faculty of Technical Sciences in Novi Sad in 1999 with a thesis on "Visualization of XML Documents". He completed his master's degree in 2007 with a master's thesis "Web Services for the Visual Interpretation of Geospatial Data". He received his PhD in 2011 on "Application of Service Model for Integrating Heterogeneous Data in the Analysis of Risk of Events with Catastrophic Consequences". Since 2000 he has been working at the Department of Applied Computer Science and Informatics, Faculty of Technical Sciences, University of Novi Sad, Department of Computer and Automation, where he has participated in the realization of several projects.

He was a doctoral student at the United Nations University in Bonn, Germany. As a guest lecturer, he has participated in the realization of several UNITED NATIONS UNIVERSITY (UNU-EHS) graduate programs.

From June 1999 to the present he was engaged in projects and teaching at the Faculty of Technical Sciences. He has published more than 100 scientific papers and participated in several projects, 30 of which are of particular interest.

Teaching experience: Programming languages and data structures (C programming language), Object-oriented programming (C ++, Java programming languages), Applied programming, Computer networks, Programming and programming languages (C programming language), Distributed and object databases, Geoinformation systems, geoinformation technologies and systems, digital terrain models, basics of cartography with geodata visualization, virtual atlases, multimedia cartography, modeling and simulation in risk management, integrated risk management, application of GIS in risk assessment, programming 1 and 2, algorithms and structures data.

He teaches Operating Systems and Computer Networks to talented students in special computer classes at "Jovan Jovanovic Zmaj" High School in Novi Sad.

## INDEX OF AUTHORS

<b>SURNAME</b>	<b>NAME</b>	<b>PAGE NUMBERS</b>			
<b>A</b>					
Andreeski	Cvetko	83			
Andelovski	Olja	163	168		
<b>B</b>					
Bakator	Mihalj	270	274		
Balci	Efecan	88			
Berković	Ivana	193	198	266	
Bertini	Enrico	88			
Bhatt	Madhusudan	334			
Bhatt	Nikita	334			
Bhatt	Sneha	334			
Bjelica	Momčilo	122			
Blazhekovikj-Toshevski	Marina	83			
Blagojević	Marija	133			
Blazheska-Tabakovska	Natasha	53	59	70	
Bocevska	Andrijana	59	79		
Bogetić	Srđan	270			
Bondžić	Jovana	177			
Brtka	Eleonora	262			
Brtka	Vladimir	100	193	198	262
<b>C</b>					
Cheresharov	Stoyan	10			
Cherkashin	Evgeny Alexandrovich	301	306		
Chorbev	Ivan	65			
<b>Ć</b>					
Ćirić	Zoran	105			
Ćočkalo	Dragan	270			
<b>D</b>					
Dem'yanovich	Vladimir Mikhailovich	288			
Denić	Nebojša	117			
Despotović	Željko	208	221		
Dianov	Vyacheslav Nikolayevich	301			
Dimitrievski	Ace	65			
Dimovski	Tome	37			
Dlabač	Tatjana	128			
Dobrilović	Dalibor	181	187	208	221
Dorodnykh	Nikita Olegovich	293			
Dorofeev	Andrey Sergeevich	301			
Dorofeev	Roman Sergeevich	301			
Dragan	Dinu	17			
Dujović	Miljan	177			

<b>Đ</b>				
Dorđević	Filip	154		
Dorđević	Dejan	270		
<b>E</b>				
Erceg	Vanja	105	112	
Eskić	Ognjan	227		
<b>F</b>				
Fedorov	Roman Konsantinovich	288		
Felix	Cristian	88		
Filiposka	Marija	49		
<b>G</b>				
Gajić	Dušan	17		
Gebow	Vladimir	311		
Gecin	Goran	202	221	
Glušac	Dragana	231		
Gostojić	Stevan	150		
Gračić	Sara	137		
Gruevski	Dragan	70		
<b>H</b>				
Hristoski	Ilija	37		
<b>I</b>				
Ipantieva	Svetlana Sergeevna	306		
Ivanovska	Lela	75		
Ivetić	Dragan	154		
<b>J</b>				
Janda	Žarko	215		
Jašić	Aleksandar	250		
Jauševac	Goran	100		
Jelev	Ivan	10		
Jokić	Snežana	145		
Jolevski	Ilija	53	70	
Jotanović	Gordana	100		
Jovanović	Blagota	215		
Jovanović	Martin	198		
Jovović	Vladan	193		
<b>K</b>				
Kazi	Ljubica	202	256	334
Kazi	Zoltan	227		
Klyuchevskii	Anatoly Vasilievich	288		
Komarov	Ivan Sergeevich	278		
Kopylova	ViktoriyaVadimovna	306		
Kostić - Zobenica	Anja	244	250	
Kotevski	Zoran	45	79	
Kovačević	Aleksandar	150		
Kraguljac	Vladimir	128		
Kupusinac	Aleksandar	154		

**Lj**

Ljubojev Nadežda 236

**M**

Malić Milan 181

Manjak Dragan 94

Marić Petar 177

Markoski Branko 244 250

Marković Marko 150

Mihajlović Siniša 240 256 262 266 315

Mihić Relja 173

Mikhailov Andrei Anatolievich 288

Milanov Dušanka 231

Milošević Danijela 128

**N**

Naneva Veselina 10

Nogo Srđan 94

**O**

Odžaklieska Dragica 37

Ognjenović Višnja 193 198 334

Orčić Timotej 150

**P**

Papić Miloš 133

Paramonov Viacheslav 288

Perišić Lidija 202 325

Petrović Milena 117

Popov Srđan 24 159 163 168 173 177

Popova Anastasia Konstantinovna 283

Porokhova Marianna Vadimovna 278

Praskić Asim 145

Premčevski Velibor 244 250 321

**R**

Radišić Rade 163 168

Radmanović Tatjana 122

Radosav Dragica 240 274

Radulović Biljana 227 256

Ranković Dragica 122

Ranković Nevena 122

Rendevski Nikola 79

Ristevski Blagoj 28 33 53 59 65 70 79

Ruzhnikov Gennady Mikhailovich 288

**S**

Salem Abdel-Badeeh 1

Savoska Snezana 33 53 59 65 70

Shigarov AlexeyOlegovich 288

Shijakova Aneta 45

Simić Novak 244

**International conference on Applied Internet and Information Technologies  
October 3-4, 2019, Zrenjanin, Republic of Serbia**

---

Simić	Srđan	193		
Sosinskaya	Sophia	278		
Spaseska	Tatjana	37		
Srdić	Vesna	145		
Stamenkovska	Andrea	53		
Stanisavljev	Sanja	236		
Stanković	Nebojša	133		
Stefanova	Kremena	10		
Stojanov	Jelena	187		
Stojanov	Željko	100	181	187
Stojanović	Nikola	150		
Stojkov	Aleksandra	240		
<b>Š</b>				
Šećerov	Ivan	177		
Šereš	Laslo	112		
Šinik	Vladimir	208	215	221
<b>T</b>				
Tanaskoska	Lenche	53		
Tokody	Daniel	181		
Trajkovik	Vladimir	65		
Trpovski	Igor	150		
<b>V</b>				
Vasiljević	Aleksandar	159		
Veljanovska	Kostandina	49		
Veselinov	Dejan	231		
<b>Y</b>				
Yurin	Alexander Yurievich	293		
<b>Z</b>				
Zakin - Kavalić	Mila	236		
Zlatković	Dragan	117		
Zlatkovski	Milan	59		
Zoranović	Tihomir	105	112	

## CONFERENCE SUPPORTING INSTITUTIONS

Municipality of Zrenjanin, Serbia

Regional Chamber of Commerce, Zrenjanin, Serbia

Regional Center for development RCR Banat, Zrenjanin, Serbia

Zrenjaninski IKT Klaster, Zrenjanin, Serbia

Business Incubator, Zrenjanin, Serbia

## COMPANIES PRESENTED at AIIT2019



<https://craterstudio.com>



<https://www.vegait sourcing.rs>

## COMPANIES PARTICIPATED at AIIT2019 ROUND TABLE



<https://www.levi9.com>



<https://www.vegait sourcing.rs>



<http://www.yuteam.co.rs>